

# MITSUBISHI

MELSECNET/B data link module type AJ71AT21B

## User's Manual

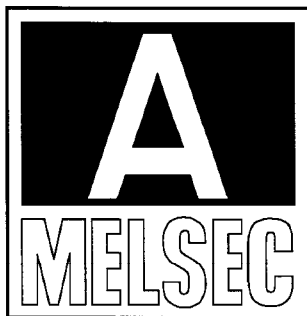
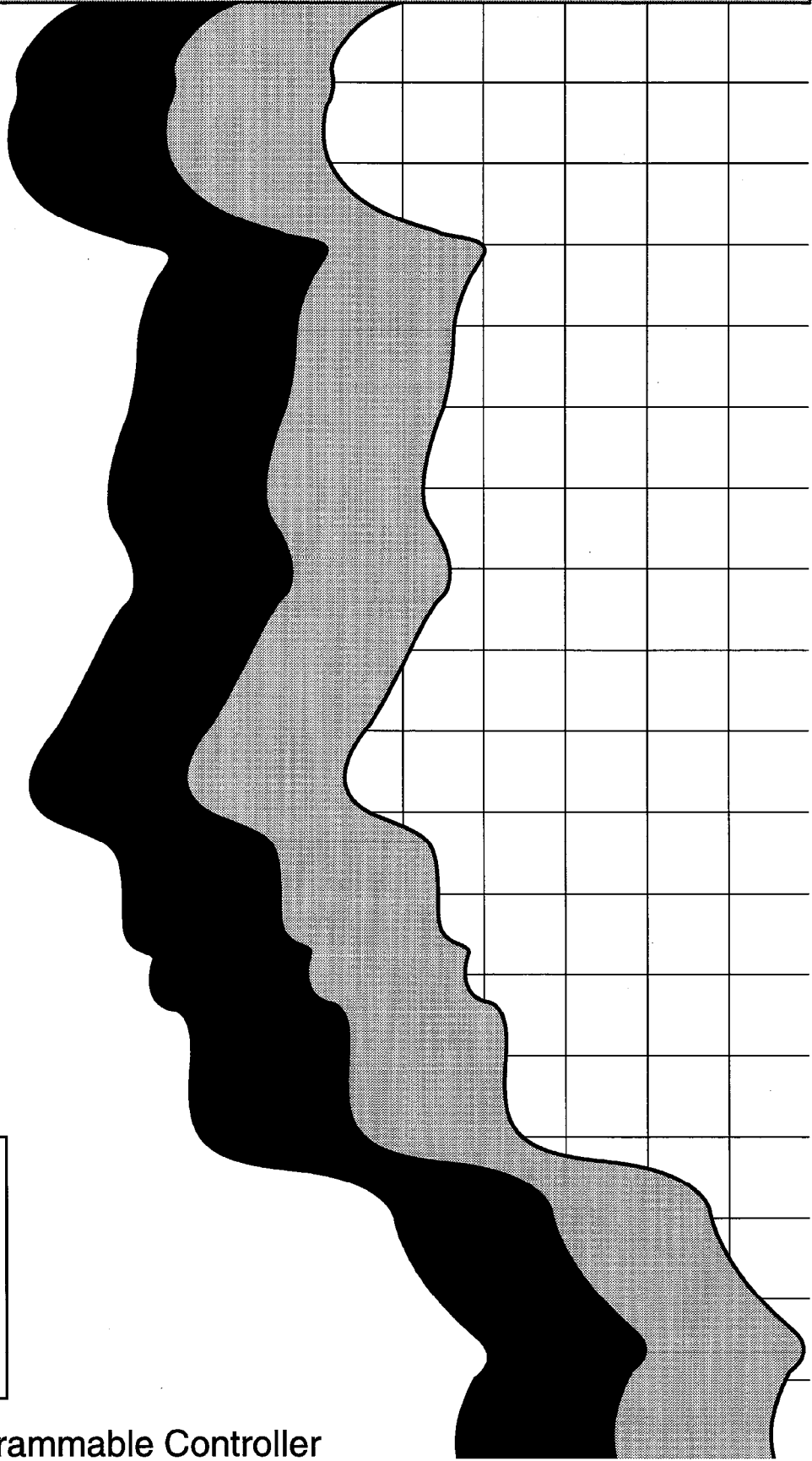

Mitsubishi Programmable Controller

## REVISIONS

\*The manual number is given on the bottom left of the back cover.

Print Date	*Manual Number	Revision
Oct., 1991	IB (NA) 66342-A	First edition

## **INTRODUCTION**

**Thank you for choosing the Mitsubishi MELSEC-A Series of General Purpose Programmable Controllers. Please read this manual carefully so that the equipment is used to its optimum. A copy of this manual should be forwarded to the end User.**

## CONTENTS

<b>1. INTRODUCTION</b> .....	<b>1-1</b>
<b>2. SPECIFICATIONS</b> .....	<b>2-1 ~ 2-3</b>
2.1 General Specifications .....	2-1
2.2 Performance Specifications .....	2-2
<b>3. HANDLING</b> .....	<b>3-1 ~ 3-4</b>
3.1 Handling Instructions .....	3-1
3.2 Part Names .....	3-2
3.3 Settings of Each Part .....	3-4
<b>4. SELF-DIAGNOSTIC TESTING</b> .....	<b>4-1 ~ 4-3</b>
4.1 Self-Loopback Test .....	4-1
4.2 Inter-Station Testing .....	4-2
<b>APPENDIX</b> .....	<b>APP-1</b>
Appendix 1 Outside Dimensions .....	APP-1

## 1. INTRODUCTION

- (1) This manual describes the specifications, part names, and self-diagnostic tests of the AJ71AT21B.

The AJ71AT21B is used with in a MELSECNET/B data link system.

- (2) The following gives the application, applicable cable, and installation location of the AJ71AT21B:

- Application : As a master or local station
- Applicable cable : Twisted wire pair cable
- Module installation location : I/O slot of a main or extension base unit

- (3) The following manual gives details about the MELSECNET/B data link system:

MELSECNET, MELSECNET/B data link system reference manual

## 2. SPECIFICATIONS

MELSEC-A

### 2. SPECIFICATIONS

This section gives the general specifications of the data link system and the performance specifications of the AJ71AT21B.

#### 2.1 General Specifications

The general specifications of the data link system are given below:

Item	Specifications				
Operating ambient temperature	0 to 55 °C				
Storage ambient temperature	-20 to 75 °C				
Operating ambient humidity	10 to 90% RH, non-condensing				
Storage ambient temperature	10 to 90% RH, non-condensing				
Vibration resistance	Conforms to ** JIS C 0911	Frequency	Acceleration	Amplitude	Sweep Count
		10 to 55 Hz	—	0.075 mm (0.003 in)	10 times *(1 octave/minute)
		55 to 150 Hz	1 G	—	
Shock resistance	Conforms to JIS C 0912 (10g X 3 times in 3 directions)				
Noise durability	By noise simulator of 1500 Vpp voltage, 1 μsec noise width and 25 to 60 Hz noise frequency				
Dielectric withstand voltage	500 VAC for 1 minute across DC external terminals and ground				
Insulation resistance	5 MΩ or greater by 500 VDC insulation resistance tester across AC external terminals and ground				
Operating ambience	Free of corrosive gases. Dust should be minimal.				
Cooling method	Self-cooling				

#### REMARK

One octave marked \* indicates a change from the initial frequency to double or half frequency. For example, any of the changes from 10 to 20 Hz, from 20 to 40 Hz, or 20 to 10 Hz are referred to as one octave.

Note: \*\* JIS: Japanese Industrial Standard

## 2. SPECIFICATIONS

MELSEC-A

### 2.2 Performance Specifications

The performance specifications of the AJ71AT21B are given below:

Item		Specifications	
Model		AJ71AT21B	
Max. number of device points allocated to communication linkage per station		Input (X) Output (Y)	Depends on the Max. number of I/O points of the utilized PC CPU.
MELSECNET mode	Max. link points for one system	B	1024 points (128 byte)
		W	1024 points (2048 byte)
	Max. link points for one station	$\frac{Y(\text{point}) + B(\text{point})}{8} + 2 \times W(\text{point}) \leq 1024 \text{ byte}$	
MELSECNET II mode	Max. link points for one system	B	4096 points (512 byte)
		W	4096 points (8192 byte)
	Max. link points for one station	$\frac{Y(\text{point}) + B(\text{point})}{8} + 2 \times W(\text{point}) \leq 1024 \text{ byte}$ (First half of link parameter) $\frac{B(\text{point})}{8} + 2 \times W(\text{point}) \leq 1024 \text{ byte}$ (Second half of link parameter)	
MELSECNET II Composite mode	Max. link points for one system	B	4096 points (512 byte)
		W	4096 points (8192 byte)
	Max. link points for one station	$\frac{Y(\text{point}) + B(\text{point})}{8} + 2 \times W(\text{point}) \leq 1024 \text{ byte}$ (First half of link parameter) $\frac{B(\text{point})}{8} + 2 \times W(\text{point}) \leq 1024 \text{ byte}$ (Second half of link parameter)	
Current consumption (5 VDC)		0.72 A	
Weight		0.33 kg	
Allowable momentary power failure time		20 msec	
Communication speeds		125K bps/250K bps/500K bps/1M bps	
Communication method		Half duplex bit serial method	
Synchronous method		Frame synchronous method	
Transmission path method		Bus type	
Overall extension distance		Varies according to the communication speed	
Modulation method		NRZI method	
Transmission format		Conforms to HDLC (frame method)	
Error control system		Retry due to CRC (generating polynomial $X^{16} + X^{12} + X^5 + 1$ ) and timeout	
RAS function		Diagnostic function such as host link line	
Connecting terminal		Terminal block	
Applicable cable		Shielded twisted wire pair cable (KNPEV-SB 0.5SQ x 1P)	
Number of occupied I/O points		32 points	

## 2. SPECIFICATIONS

## MELSEC-A

### REMARK

- (1) The overall extension distance is the distance between both end stations in the MELSECNET/B data link system.

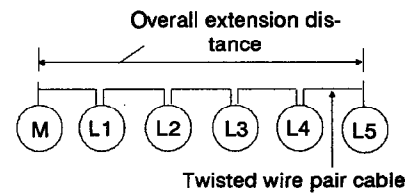

- (2) The relationship between communication speeds and the overall extension distance is shown below:

	Communication Speeds			
	125K bps	250K bps	500K bps	1 M bps
Overall extension distance	1200 m	600 m	400 m	200 m



### 3. HANDLING

#### 3.1 Handling Instructions

Handle the AJ71AT21B as indicated below:

- (1) Protect the case from impact, since it is made from resin.
- (2) Do not touch or remove the printed circuit boards from the case.
- (3) When wiring, make every effort to keep wire offcuts from entering the module. Make sure to remove any which do enter the module.
- (4) To install the module to the base unit, tighten the screws as indicated:

Screw Location	Tightening Torque Range (kg-cm)
Cable terminal screw (M3.5 screw)	6 to 9
Terminal block mounting screw (M3.5 screw)	6 to 9
Module mounting screw (M4 screw)	8 to 12

### 3. HANDLING

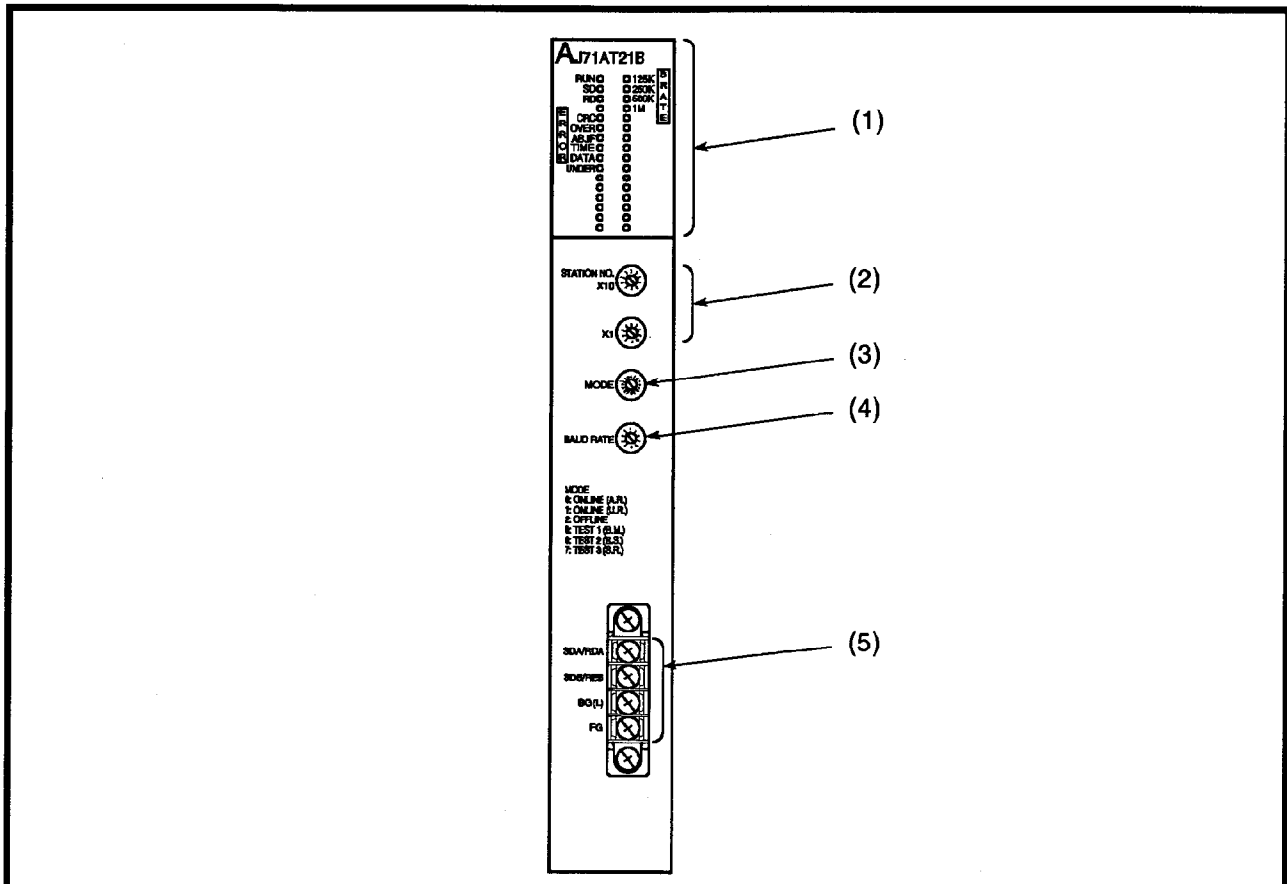

#### 3.2 Part Names

The part names of the AJ71AT21B and their applications are given below:



No.	Name (Enlarged View)	Application				
		LED	Operation	LED	Operation	
(1)	Operation State and Error Indication LED	RUN	Flashes when AJ71AT21B is running	125K	Baud rate setting indication	
	RUN ○ ○ 125K	SD	Flashes during data sending	250K		
	SD ○ ○ 250K	RD	Flashes during data receiving	500K		
	RD ○ ○ 500K		Not used	1M		
						Not used

### 3. HANDLING

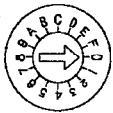
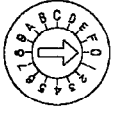
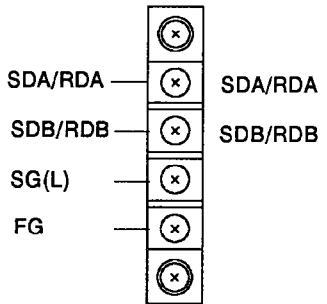
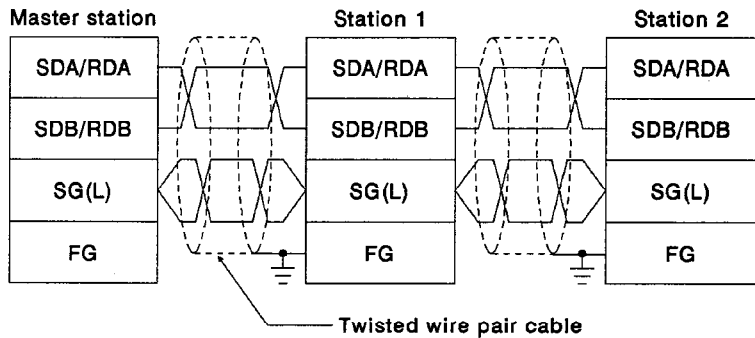
No.	Name (Enlarged View)	Application																											
(2)	Station Number Setting Switch	<ul style="list-style-type: none"> <li>● Set a station number within the range of 00 to 31.</li> <li>● Set the ×10 switch corresponding to the first number of the station.</li> <li>● Set the ×1 switch corresponding to the second number of the station.</li> <li>● When this station is used as the master station, set these switches to 0 and 0.</li> <li>● When this station is used as a local station, set these switches within the range of 01 to 31.</li> </ul>																											
	STATION. NO × 10   × 1 																												
(3)	Mode Selection Switch	<ul style="list-style-type: none"> <li>● The following modes can be selected using the mode selection switch:</li> </ul>																											
	MODE 	<table border="1"> <thead> <tr> <th>Setting Number</th> <th>Name</th> <th>Description</th> </tr> </thead> <tbody> <tr> <td>0</td> <td>Online (A.R)</td> <td>Automatically returns when the module operates normally.</td> </tr> <tr> <td>1</td> <td>Online (U.R)</td> <td>Does not automatically return when the module operates normally.</td> </tr> <tr> <td>2</td> <td>Offline</td> <td>Releases the self station.</td> </tr> <tr> <td>3.4</td> <td>—</td> <td>Unused</td> </tr> <tr> <td>5</td> <td>Test 1 (B.M)</td> <td>Inter-station test mode (master station)</td> </tr> <tr> <td>6</td> <td>Test 2 (B.S)</td> <td>Inter-station test mode (slave station)</td> </tr> <tr> <td>7</td> <td>Test 3 (S.R)</td> <td>Self-loopback test</td> </tr> <tr> <td>8 to F</td> <td>—</td> <td>Unusable</td> </tr> </tbody> </table>	Setting Number	Name	Description	0	Online (A.R)	Automatically returns when the module operates normally.	1	Online (U.R)	Does not automatically return when the module operates normally.	2	Offline	Releases the self station.	3.4	—	Unused	5	Test 1 (B.M)	Inter-station test mode (master station)	6	Test 2 (B.S)	Inter-station test mode (slave station)	7	Test 3 (S.R)	Self-loopback test	8 to F	—	Unusable
		Setting Number	Name	Description																									
		0	Online (A.R)	Automatically returns when the module operates normally.																									
		1	Online (U.R)	Does not automatically return when the module operates normally.																									
		2	Offline	Releases the self station.																									
		3.4	—	Unused																									
		5	Test 1 (B.M)	Inter-station test mode (master station)																									
		6	Test 2 (B.S)	Inter-station test mode (slave station)																									
7	Test 3 (S.R)	Self-loopback test																											
8 to F	—	Unusable																											
BAUD RATE 	<table border="1"> <thead> <tr> <th>Setting Number</th> <th>Baud Rate</th> </tr> </thead> <tbody> <tr> <td>0</td> <td>125K bps</td> </tr> <tr> <td>1</td> <td>250K bps</td> </tr> <tr> <td>2</td> <td>500K bps</td> </tr> <tr> <td>3</td> <td>1M bps</td> </tr> <tr> <td>4 to F</td> <td>Unused*</td> </tr> </tbody> </table>	Setting Number	Baud Rate	0	125K bps	1	250K bps	2	500K bps	3	1M bps	4 to F	Unused*																
	Setting Number	Baud Rate																											
	0	125K bps																											
	1	250K bps																											
	2	500K bps																											
3	1M bps																												
4 to F	Unused*																												
* If the switch is set to any number from 4 to F, the LED (DATA) goes ON and the module goes into the offline state.																													
(5)	Terminal Block	<ul style="list-style-type: none"> <li>● How to wire the stations is shown in the POINT below *1:</li> </ul>																											
																													

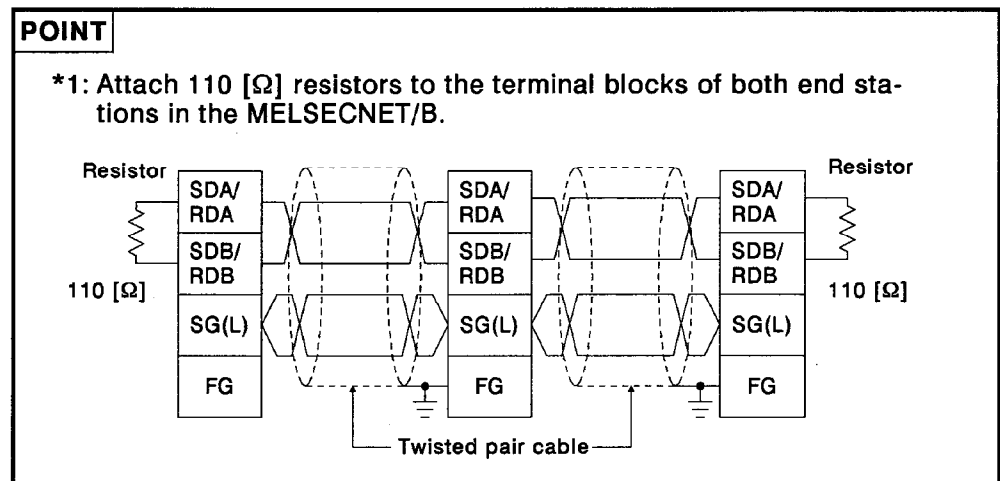

### 3.3 Settings of Each Part

- (1) Set the link module in the data link system as shown below:
  - (a) Station number switch setting
 

Specify the station number of the AJ71AT21B within the range of 00 to 31.
  - (b) Mode switch setting
 

Sets the operation mode and the self-diagnosis mode.
  - (c) Link parameter setting using a peripheral device
 

When the AJ71AT21B is used as a master station, set a link parameter in the PC CPU.
- (2) The MELSECNET, MELSECNET/B data link reference manual gives details.

## 4. SELF-DIAGNOSTIC TESTING

- (1) Self-diagnostic tests are done to check (a) the hardware of the AJ71AT21B and (b) twisted pair cable disconnections between the AJ71AT21B and the CPU.

Select one of the three modes using the mode setting switch as shown below:

Switch Setting	Mode	Description
5	Inter-station test (master station)	Checks the line between the two stations. Set one station as the master station and the other as the slave station, then execute the check.
6	Inter-station test (slave station)	
7	Self-loopback test	Checks the hardware using an independent AJ71AT21B.

- (2) Only the self-loopback test procedure is explained here. The MELSECNET, MELSECNET/B data link system reference manual gives details about other procedures.

### 4.1 Self-Loopback Test

- (1) Self-loopback test

Checks the hardware using an independent AJ71AT21B.

- (2) Test procedure

The self-loopback test procedure is shown below:

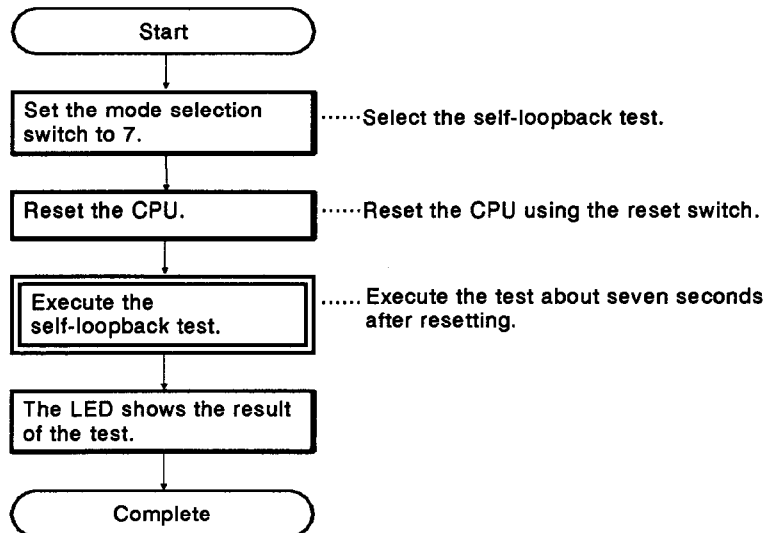

- (3) Test results

The LEDs on the front of the AJ71AT21B show the test results.

- (a) If the AJ71AT21B is working normally, the LED flashing begins with CRC, followed by OVER, AB.IF, TIME, DATA, and UNDER.
- (b) When the AJ71AT21B works abnormally, the LED corresponding to the error goes ON. If the test ends before completion, the hardware could be faulty.

## 4. SELF-DIAGNOSTIC TESTING

MELSEC-A

### 4.2 Inter-Station Testing

- (1) Checks the line between the two adjoining stations.

The test checks if (a) the slave station (AJ71AT21B) retransmits the data transmitted by the master station (AJ71AT21B) within a certain time and (b) determines whether or not the hardware is faulty.

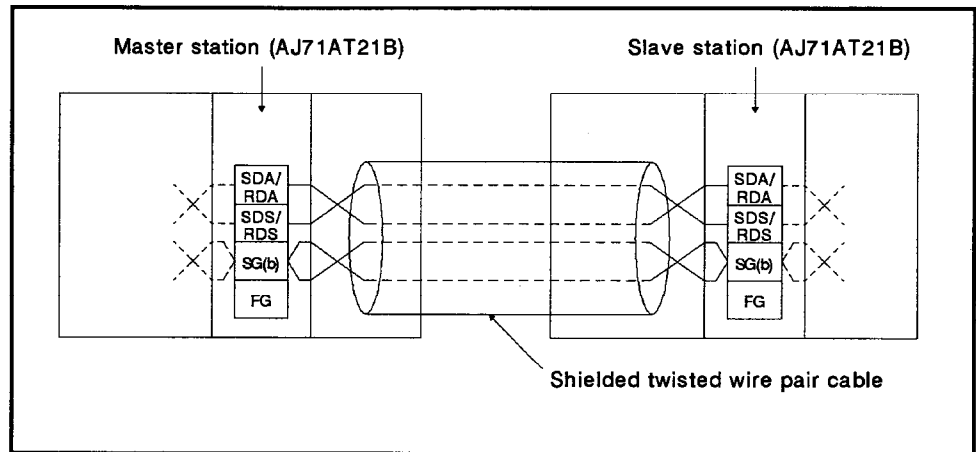
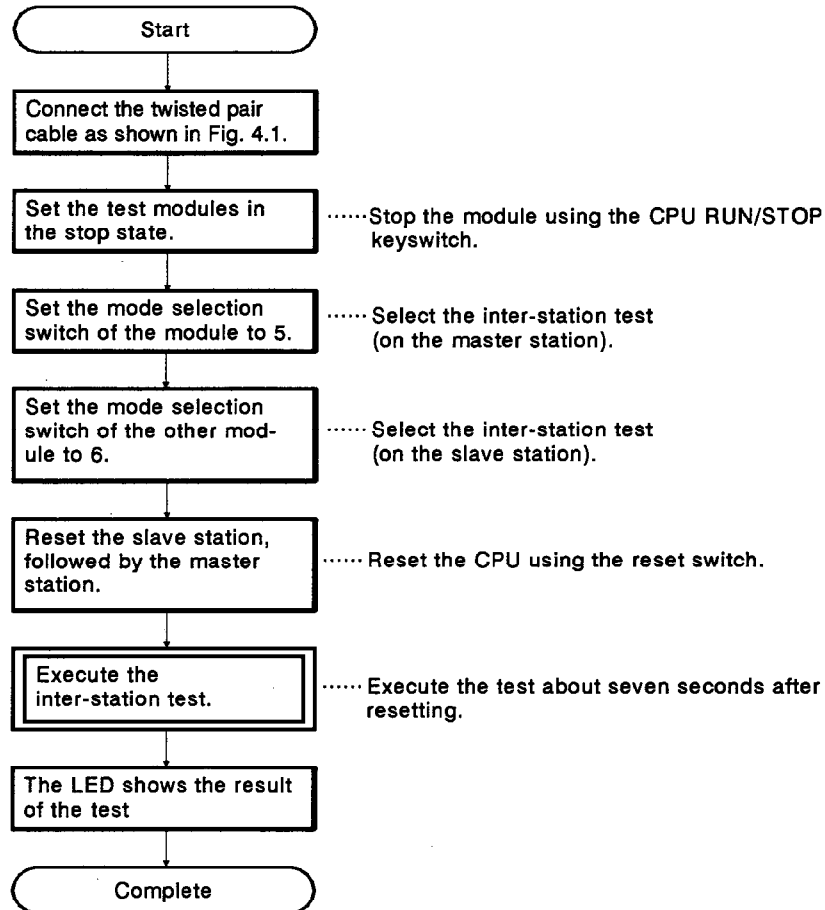

Fig. 4-1 Inter-Station Test

### (2) Test procedure

The inter-station test procedure is shown below:



### (3) Test results

The LEDs on the front of the AJ71AT21B show the test results.

- (a) If the AJ71AT21B is working normally, the LED flashing begins with the CRC, followed by OVER, AB.IF, TIME, DATA, and UNDER.
- (b) When the AJ71AT21B works abnormally, the LED corresponding to the error goes ON. If the test ends before completion, one of the following events has occurred:
  - 1) The hardware is faulty;
  - 2) A cable became disconnected during the test;
  - 3) A cable line was cut during the test.





**IMPORTANT**

The components on the printed circuit boards will be damaged by static electricity, so avoid handling them directly. If it is necessary to handle them take the following precautions.

- (1) Ground human body and work bench.
- (2) Do not touch the conductive areas of the printed circuit board and its electrical parts with any non-grounded tools etc.





# MELSECNET/B data link module type AJ71AT21B

## User's Manual

MODEL	AJ71AT21B-U-E
MODEL CODE	13J679
IB(NA)-66342-A(9110)MEE	

 **MITSUBISHI ELECTRIC CORPORATION**

HEAD OFFICE : MITSUBISHI DENKI BLDG MARUNOUCHI TOKYO 100-8810 TELEX : J24532 CABLE MELCO TOKYO  
NAGOYA WORKS : 1-14, YADA-MINAMI 5, HIGASHI-KU, NAGOYA, JAPAN

When exported from Japan, this manual does not require application to the Ministry of International Trade and Industry for service transaction permission.

Specifications subject to change without notice.

Printed in Japan on recycled paper.