

MITSUBISHI

MELSECNET/B data link module type AJ72T25B

User's Manual

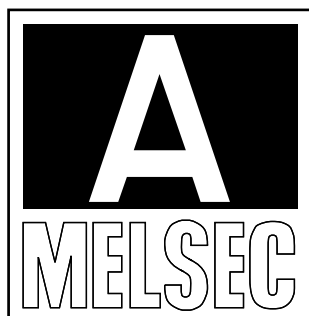
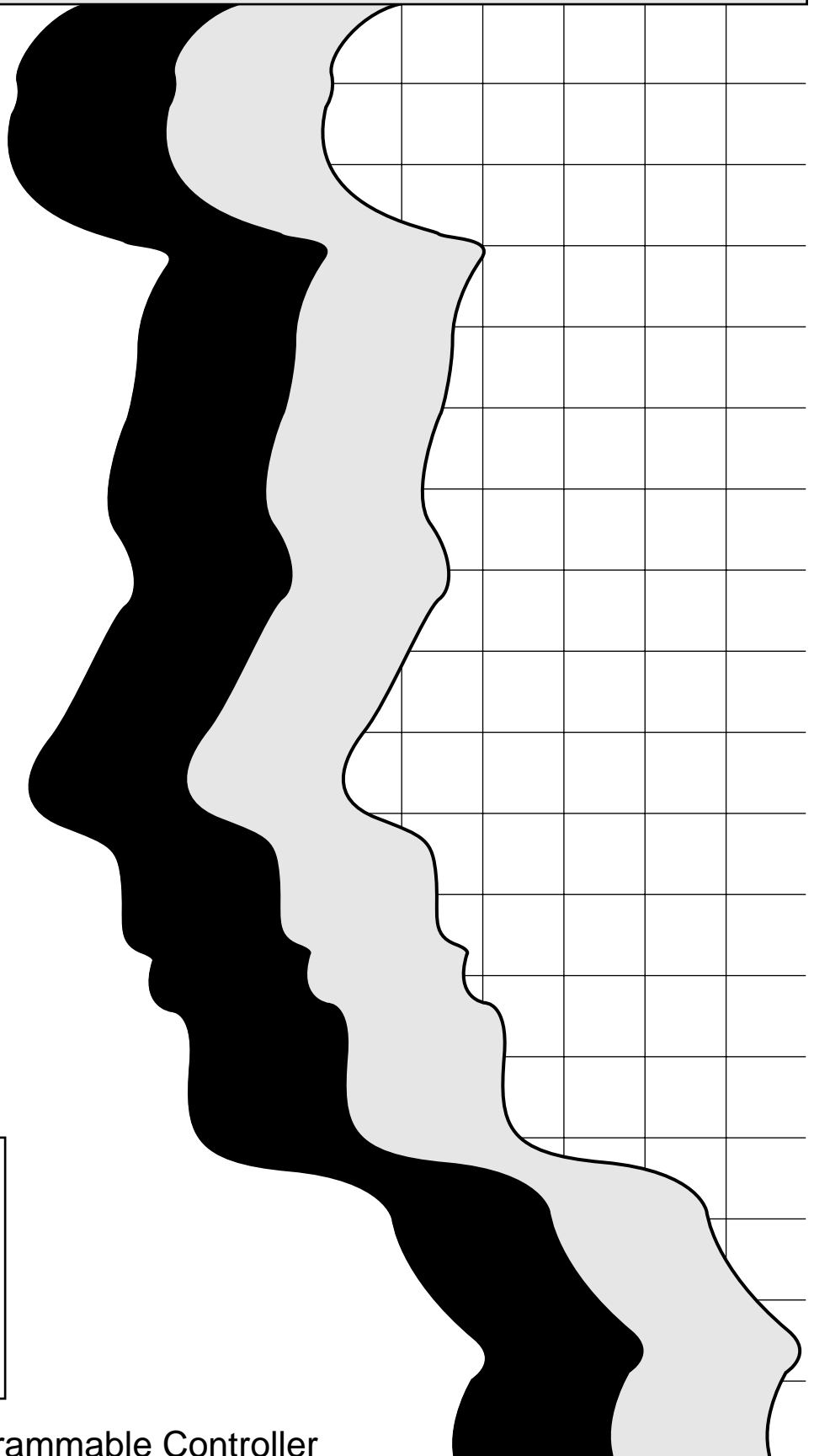

Mitsubishi Programmable Controller

INTRODUCTION

Thank you for choosing the Mitsubishi MELSEC-A Series of General Purpose Programmable Controllers. Please read this manual carefully so that the equipment is used to its optimum. A copy of this manual should be forwarded to the end User.

REVISIONS

*The manual number is given on the bottom left of the back cover.

Print Date	*Manual Number	Revision
Mar., 1994	IB (NA) 66464-A	First edition

CONTENTS

1. GENERAL DESCRIPTION	1-1
2. SPECIFICATIONS	2-1 ~ 2-2
2.1 General Specifications	2-1
2.2 Performance Specifications	2-2
3. HANDLING	3-1 ~ 3-4
3.1 Handling Instructions	3-1
3.2 Part Names	3-2
3.3 Settings of Each Part	3-4
4. SELF-DIAGNOSTIC TESTING	4-1 ~ 4-4
4.1 Self-Loopback Test	4-1
4.2 Inter-Station Test	4-2
APPENDICES	APP-1
APPENDIX 1 OUTSIDE DIMENSIONS	APP-1

1. GENERAL DESCRIPTION

- (1) This manual describes the specifications, part names, and self-diagnostic tests of the AJ72T25B.

The AJ72T25B is used with in a MELSECNET/B data link system (Bus system).

- (2) The following gives the application, applicable cable, and installation location of the AJ72T25B:

- Application : As a remote I/O station
- Applicable cable : Twisted wire pair cable
- Module installation location : CPU slot of a main base unit

- (3) The following manual gives details about the MELSECNET/B data link system:

MELSECNET, MELSECNET/B data link system reference manual
(IB(NA)-66350-A)

2. SPECIFICATIONS

MELSEC-A

2. SPECIFICATIONS

This section gives the general specifications of the data link system and the performance specifications of the AJ72T25B.

2.1 General Specifications

The general specifications of the data link system are given below:

Item	Specifications				
Operating ambient temperature	0 to 55 °C				
Storage ambient temperature	-20 to 75 °C				
Operating ambient humidity	10 to 90% RH, non-condensing				
Storage ambient temperature	10 to 90% RH, non-condensing				
Vibration resistance	Conforms to *2JIS C 0911	Frequency	Acceleration	Amplitude	Sweep Count
		10 to 55 Hz	—	0.075 mm (0.003 in)	10 times *1 (1 octave/ minute)
		55 to 150 Hz	9.8 m/s ² (1g)	—	
Shock resistance	Conforms to *2JIS C 0912 (98 m/s ² (10g) X 3 times in 3 directions)				
Noise durability	By noise simulator of 1500 Vpp voltage, 1 μsec noise width and 25 to 60 Hz noise frequency				
Dielectric withstand voltage	1500 VAC for 1 minute across AC external terminals and ground				
Insulation resistance	5 MΩ or greater by 500 VDC insulation resistance tester across AC external terminals and ground.				
Grounding	Class 3 grounding; Ground to the panel if proper grounding is not available.				
Operating ambience	Free of corrosive gases. Dust should be minimal.				
Cooling method	Self-cooling				

REMARK

One octave marked *1 indicates a change from the initial frequency to double or half frequency. For example, any of the changes from 10 to 20 Hz, from 20 to 40 Hz, or 20 to 10 Hz are referred to as one octave.

*2: JIS: Japanese Industrial Standard

2. SPECIFICATIONS

MELSEC-A

2.2 Performance Specifications

The performance specifications of the AJ72T25B are given below:

Item		Specifications
Model		AJ72T25B
Max. number of device points allocated to communication linkage per station	Input (X) Output (Y)	X, Y total 512 points
MELSECNET mode	Max. link points for one station	$\frac{X(\text{points}) + Y(\text{points})}{8} + 2 \times W(\text{points}) \leq 512 \text{ bytes}$
MELSECNET II composite mode	Max. link points for one station	$\frac{X(\text{points}) + Y(\text{points})}{8} + 2 \times W(\text{points}) \leq 512 \text{ bytes}$
Current consumption (5 VDC)		0.3 A
Weight Kg (lb)		0.5 (1.1)
Allowable momentary power failure time		20 msec
Communication speeds		125K bps/250K bps/500K bps/1M bps
Communication method		Half duplex bit serial method
Synchronous method		Frame synchronous method
Transmission path method		Bus type
Overall extension distance		Varies according to the communication speed
Number of connected stations		Max. 32 units (1 master station, 31 local or remote I/O stations)
Modulation method		NRZI method
Transmission format		Conforms to HDLC (frame method)
Error control system		Retry due to CRC (generating polynomial $X^{16} + X^{12} + X^5 + 1$) and timeout
RAS function		Diagnostic function such as host link line
Connecting terminal		Terminal block
Applicable cable		Shielded twisted wire pair cable (KNPEV-SB 0.5SQ x 1P)

REMARK

(1) The overall extension distance is the distance between both end stations in the MELSECNET/B data link system.

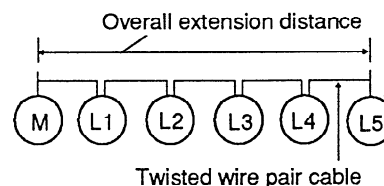

(2) The relationship between communication speeds and the overall extension distance is shown below:

	Communication Speeds			
	125K bps	250K bps	500K bps	1M bps
Overall extension distance	1200 m (3936 ft)	600 m (1968 ft)	400 m (1312 ft)	200 m (656 ft)

3. HANDLING

3.1 Handling Instructions

Handle the AJ72T25B as indicated below:

- (1) Protect the case from impact, since it is made from resin.
- (2) Do not touch or remove the printed circuit boards from the case.
- (3) When wiring, make every effort to keep wire offcuts from entering the module. Make sure to remove any which do enter the module.
- (4) To install the module to the base unit, tighten the screws as indicated:

Screw Location	Tightening Torque Range N·cm (kg·cm) [lb·inch]
Cable terminal screw (M3.5 screw)	58.8 (6) [5.2] to 88.2 (9) [7.79]
Terminal block mounting screw (M3.5 screw)	58.8 (6) [5.2] to 88.2 (9) [7.79]
Module mounting screw (M4 screw)	78.4 (8) [6.93] to 117.6 (12) [10.39]

3. HANDLING

3.2 Part Names

The part names of the A1SJ72T25B and their applications are given below:

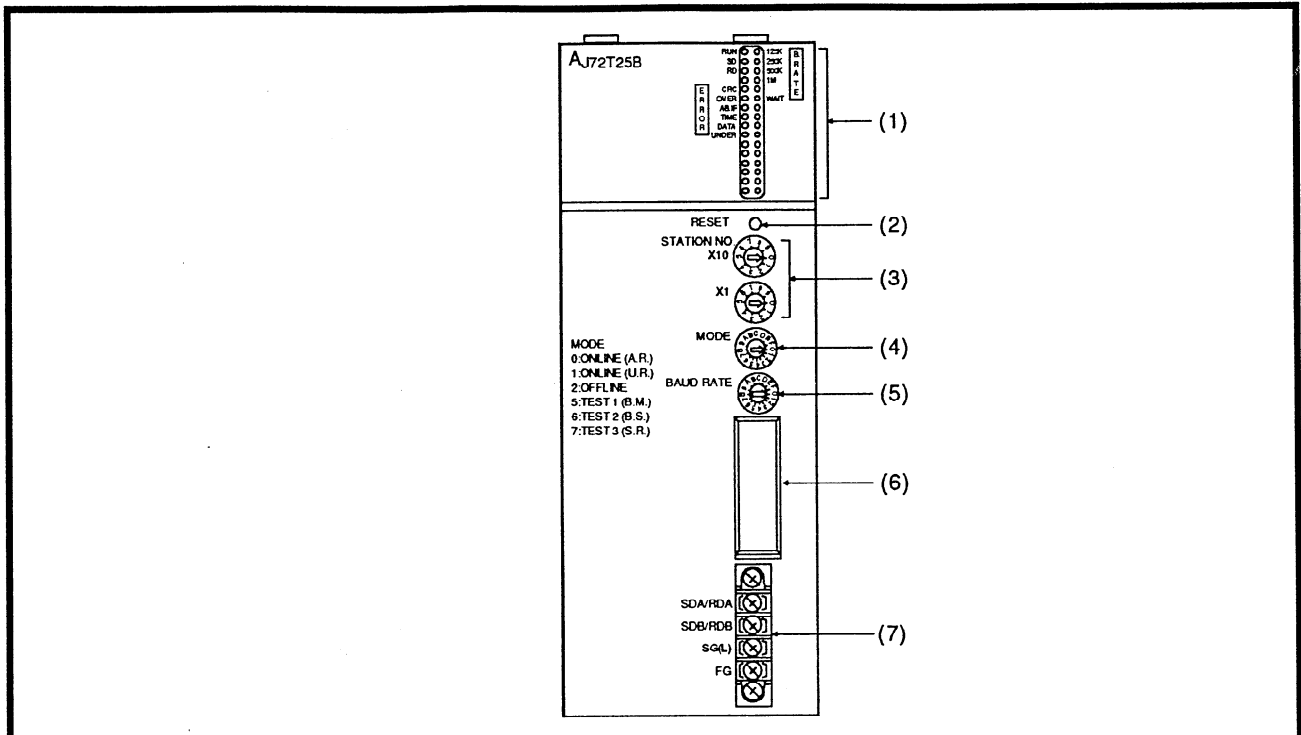

No.	Name (Enlarged View)	Application			
		LED	Operation	LED	Operation
(1)	Operation State and Error Indication LED	RUN	Goes ON when data link is normal.	125K	Indicate the baud rate.
		SD	ON during data sending	250K	
		RD	Flashes during data receiving	500K	
		CRC	Goes ON when a code check error is detected	1M	
		OVER	Goes ON when a data read is delayed	WAIT	ON during wait for the communication with special function module.
		AB. IF	ON when all data consists of 1s		Not used
		TIME	Goes ON when a timeout occurs.		
		DATA	Goes ON when a data error occurs.		
		UNDER	Goes ON when an underrun error occurs.		
			Not used		
(2)		Reset Switch		<ul style="list-style-type: none"> Used to reset the hardware of its own station at data link error time. After moving the station number setting switches and mode select switch, perform reset operation to erase the previous setting. 	

3. HANDLING

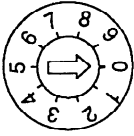
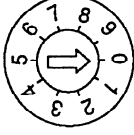
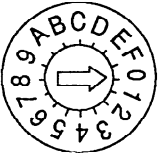
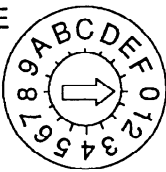
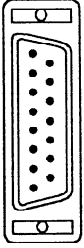
No.	Name (Enlarged View)	Application																											
(3)	<p>Station Number Setting Switch</p> <p>STATION NO. X10</p>  <p>X1</p> 	<ul style="list-style-type: none"> • Set a station number within the range of 01 to 31. • Set the X10 switch corresponding to the first number of the station. • Set the X1 switch corresponding to the second number of the station. • Set these switches within the range of 01 to 31. 																											
(4)	<p>Mode Selection Switch</p> <p>MODE</p> 	<ul style="list-style-type: none"> • The following modes can be selected using the mode selection switch: <table border="1" data-bbox="614 698 1420 1160"> <thead> <tr> <th>Setting Number</th> <th>Name</th> <th>Description</th> </tr> </thead> <tbody> <tr> <td>0</td> <td>Online (A.R)</td> <td>Automatically returns when the module operates normally.</td> </tr> <tr> <td>1</td> <td>Online (U.R)</td> <td>Does not automatically return when the module operates normally.</td> </tr> <tr> <td>2</td> <td>Offline</td> <td>Releases the self station.</td> </tr> <tr> <td>3.4</td> <td>—</td> <td>Unused*</td> </tr> <tr> <td>5</td> <td>Test 1 (B.M)</td> <td>Inter-station test mode (master station)</td> </tr> <tr> <td>6</td> <td>Test 2 (B.S)</td> <td>Inter-station test mode (slave station)</td> </tr> <tr> <td>7</td> <td>Test 3 (S.R)</td> <td>Self-loopback test</td> </tr> <tr> <td>8 to F</td> <td>—</td> <td>Unusable*</td> </tr> </tbody> </table> <p>* If the switch is set to any number from 4 to F, the LED (DATA) goes ON and the module goes into the offline state.</p>	Setting Number	Name	Description	0	Online (A.R)	Automatically returns when the module operates normally.	1	Online (U.R)	Does not automatically return when the module operates normally.	2	Offline	Releases the self station.	3.4	—	Unused*	5	Test 1 (B.M)	Inter-station test mode (master station)	6	Test 2 (B.S)	Inter-station test mode (slave station)	7	Test 3 (S.R)	Self-loopback test	8 to F	—	Unusable*
Setting Number	Name	Description																											
0	Online (A.R)	Automatically returns when the module operates normally.																											
1	Online (U.R)	Does not automatically return when the module operates normally.																											
2	Offline	Releases the self station.																											
3.4	—	Unused*																											
5	Test 1 (B.M)	Inter-station test mode (master station)																											
6	Test 2 (B.S)	Inter-station test mode (slave station)																											
7	Test 3 (S.R)	Self-loopback test																											
8 to F	—	Unusable*																											
(5)	<p>Baud Rate Switch</p> <p>BAUD RATE</p> 	<table border="1" data-bbox="614 1227 1420 1496"> <thead> <tr> <th>Setting Number</th> <th>Baud Rate</th> </tr> </thead> <tbody> <tr> <td>0</td> <td>125K bps</td> </tr> <tr> <td>1</td> <td>250K bps</td> </tr> <tr> <td>2</td> <td>500K bps</td> </tr> <tr> <td>3</td> <td>1M bps</td> </tr> <tr> <td>4 to F</td> <td>Unused*</td> </tr> </tbody> </table> <p>* If the switch is set to any number from 4 to F, the LED (DATA) goes ON and the module goes into the offline state.</p>	Setting Number	Baud Rate	0	125K bps	1	250K bps	2	500K bps	3	1M bps	4 to F	Unused*															
Setting Number	Baud Rate																												
0	125K bps																												
1	250K bps																												
2	500K bps																												
3	1M bps																												
4 to F	Unused*																												
(6)	<p>RS-422 Connector</p> 	<ul style="list-style-type: none"> • Used to connect to peripheral devices. • Covered when not in use. 																											

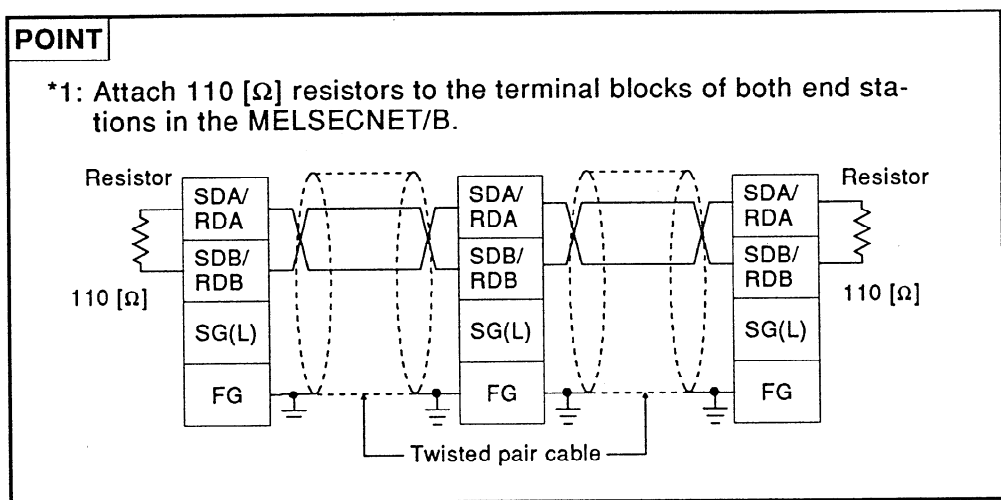
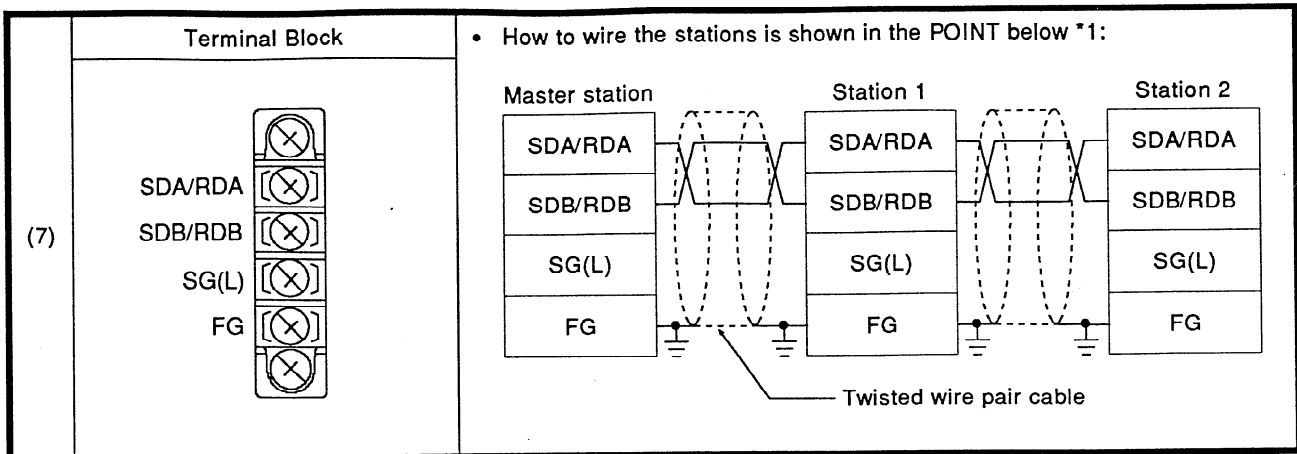

3.3 Settings of Each Part

- (1) Set the link module in the data link system as shown below:
 - (a) Station number switch setting

Specify the station number of the AJ72T25B within the range of 01 to 31.
 - (b) Mode switch setting

Sets the operation mode and the self-diagnosis mode.
 - (c) Link parameter setting using a peripheral device

When the AJ72T25B is used as a remote I/O station, set a link parameter in the PC CPU.

- (2) The MELSECNET, MELSECNET/B data link reference manual gives details.

4. SELF-DIAGNOSTIC TESTING

- (1) Self-diagnostic tests are done to check (a) the hardware of the AJ72T25B and (b) twisted pair cable disconnections between the AJ72T25B and the other stations.

Select one of the three modes using the mode setting switch as shown below:

Switch Setting	Mode	Description
5	Inter-station test (master station)	Checks the line between the two stations. Set one station as the master station and the other as the slave station, then execute the check.
6	Inter-station test (slave station)	
7	Self-loopback test	Checks the hardware using an independent AJ72T25B.

- (2) Only the self-loopback test procedure is explained here. The MELSECNET, MELSECNET/B data link system reference manual gives details about other procedures.

4.1 Self-Loopback Test

- (1) Self-loopback test

Checks the hardware using an independent AJ72T25B.

- (2) Test procedure

The self-loopback test procedure is shown below:

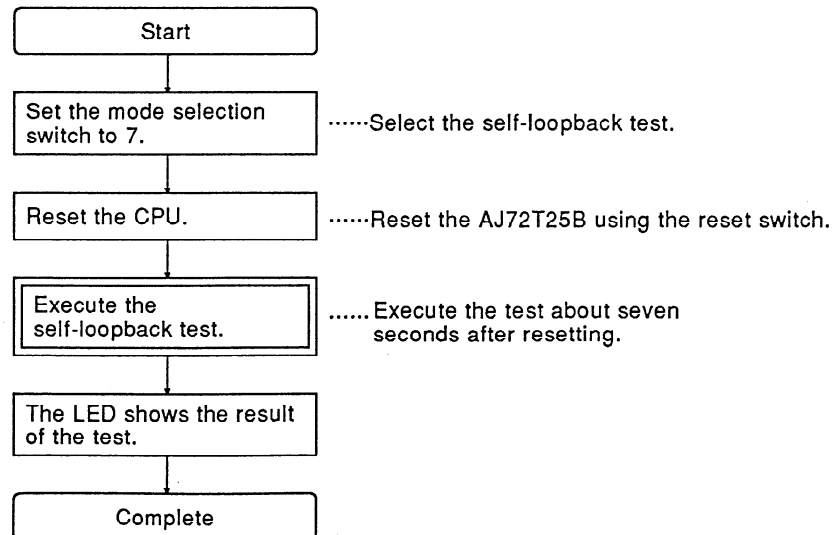

- (3) Test results

The LEDs on the front of the AJ72T25B show the test results.

- (a) If the AJ72T25B is working normally, the LED flashing begins with CRC, followed by OVER, AB.IF, TIME, DATA, and UNDER.
- (b) When the AJ72T25B works abnormally, the LED corresponding to the error goes ON. If the test ends before completion, the hardware could be faulty.

4.2 Inter-Station Test

- (1) The AJ72T25B inter-station test is used to check the line between two MELSECNET/B stations. A judgment of normal or abnormal is made on the basis of whether or not data sent from the AJ72T25B or AJ71AT21B set as the master station is returned from the AJ72T25B or AJ71AT21B set as the slave station.

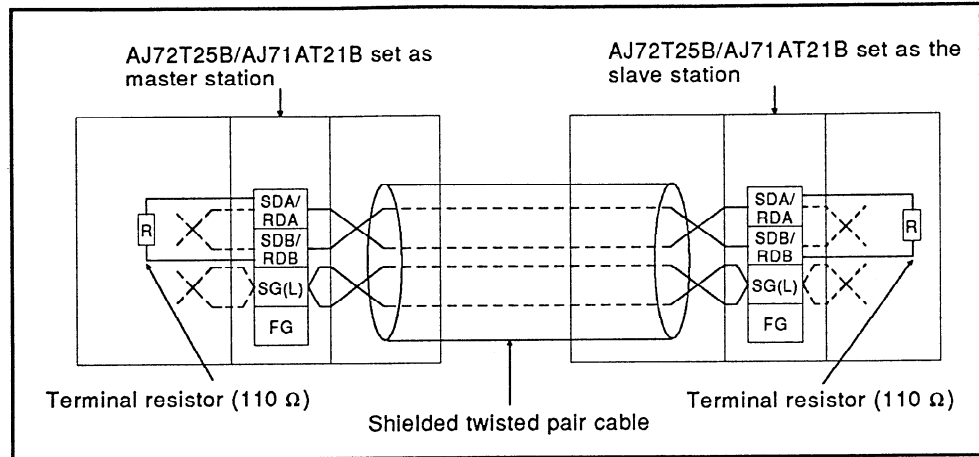

Fig. 4.1 Inter-Station Test

- (2) The AJ72T25B (remote I/O station) inter-station test can be executed between the following pairs of stations:

- An AJ72T25B (remote I/O station) and an AJ71AT21B (master station/local station)
- An AJ72T25B (remote I/O station) and an AJ72T25B (remote I/O station)

(For details on the inter-station tests between master stations and local stations, refer to the AJ71AT21B User's Manual.)

POINT

110 Ω terminal resistors must be connected between SDA/RDA and SDB/RDB for the two stations between which the inter-station test is executed.

(3) Test method

The procedure for the AJ72T25B (remote I/O station) inter-station test is given below.

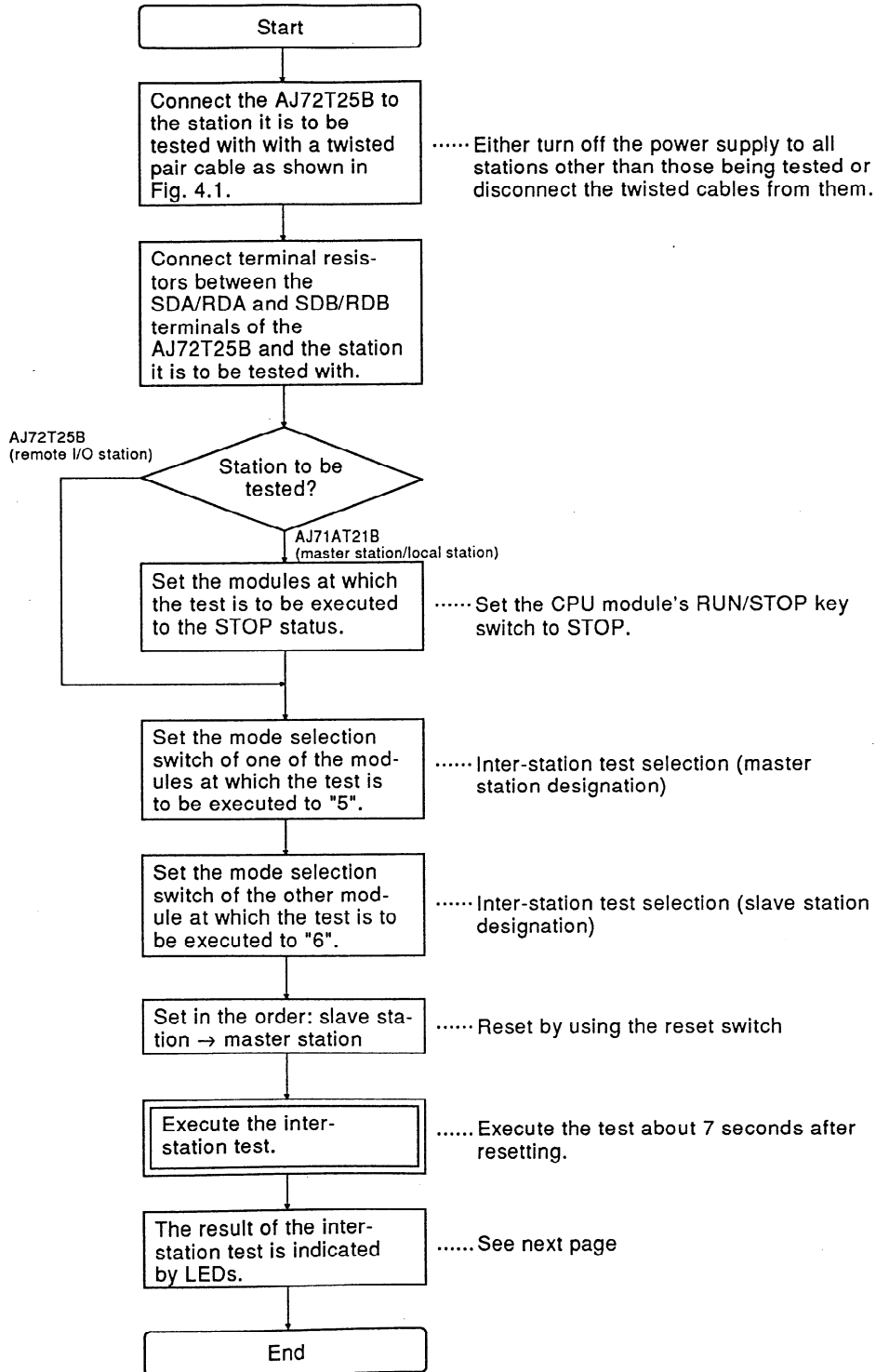

(4) Test result

The test result is indicated by the LEDs on the AJ72T25B.

- (a) If normal..... The LEDs flash in the following order: "CRC", "OVER", "AB.IF", "TIME", "DATA", "UNDER".
- (b) If abnormal.... If a fault-indicating LED lights or the test ends before completion, the possibilities are as follows:
 - 1) Hardware error
 - 2) Cable disconnected during the test
 - 3) Cable breakage during the test

APPENDIX

APPENDIX 1 OUTSIDE DIMENSIONS

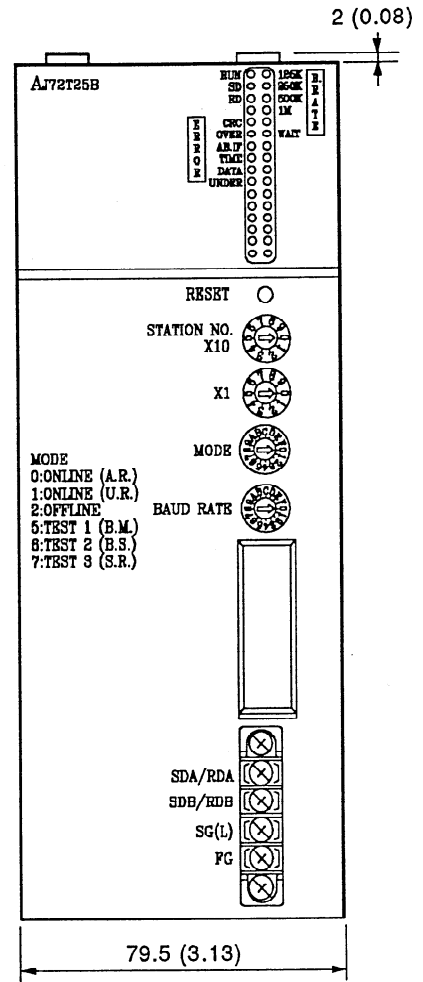
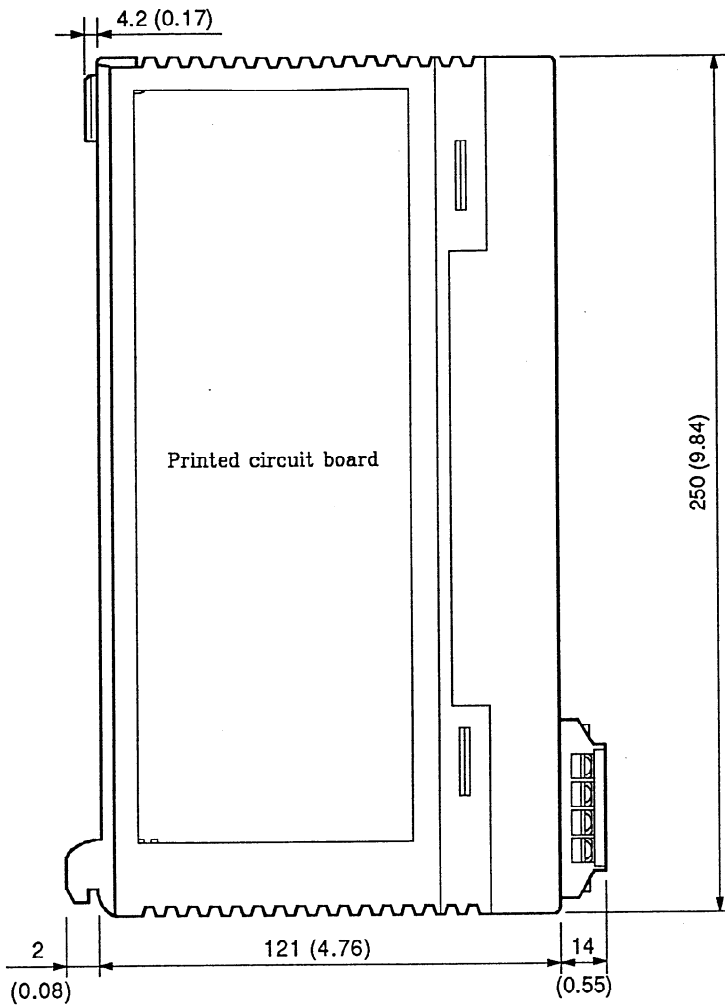

Unit: mm (inch)

IMPORTANT

- (1) Design the configuration of a system to provide an external protective or safety interlocking circuit for the PCs.
- (2) The components on the printed circuit boards will be damaged by static electricity, so avoid handling them directly. If it is necessary to handle them take the following precautions.
 - (a) Ground human body and work bench.
 - (b) Do not touch the conductive areas of the printed circuit board and its electrical parts with and non-grounded tools etc.

Under no circumstances will Mitsubishi Electric be liable or responsible for any consequential damage that may arise as a result of the installation or use of this equipment.

All examples and diagrams shown in this manual are intended only as an aid to understanding the text, not to guarantee operation. Mitsubishi Electric will accept no responsibility for actual use of the product based on these illustrative examples.

Owing to the very great variety in possible applications of this equipment, you must satisfy yourself as to its suitability for your specific application.

MELSECNET/B data link module type AJ72T25B

User's Manual

MODEL	AJ72T25B-U-E
MODEL CODE	13JE42
IB(NA)66464-A(9403)MEE	

 **mitsubishi electric corporation**

HEAD OFFICE : MITSUBISHI DENKI BLDG MARUNOUCHI TOKYO 100-0005 TELEX : J24532 CABLE MELCO TOKYO
NAGOYA WORKS : 1-14 , YADA-MINAMI 5 , HIGASHI-KU, NAGOYA , JAPAN

When exported from Japan, this manual does not require application to the Ministry of International Trade and Industry for service transaction permission.

Specifications subject to change without notice.