

# MITSUBISHI

Analog-Digital Converter Module type A68AD-S2

User's Manual

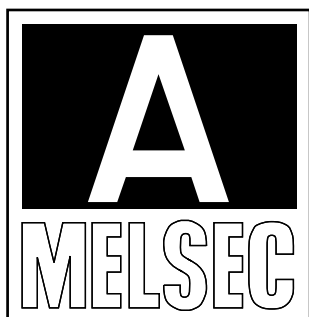
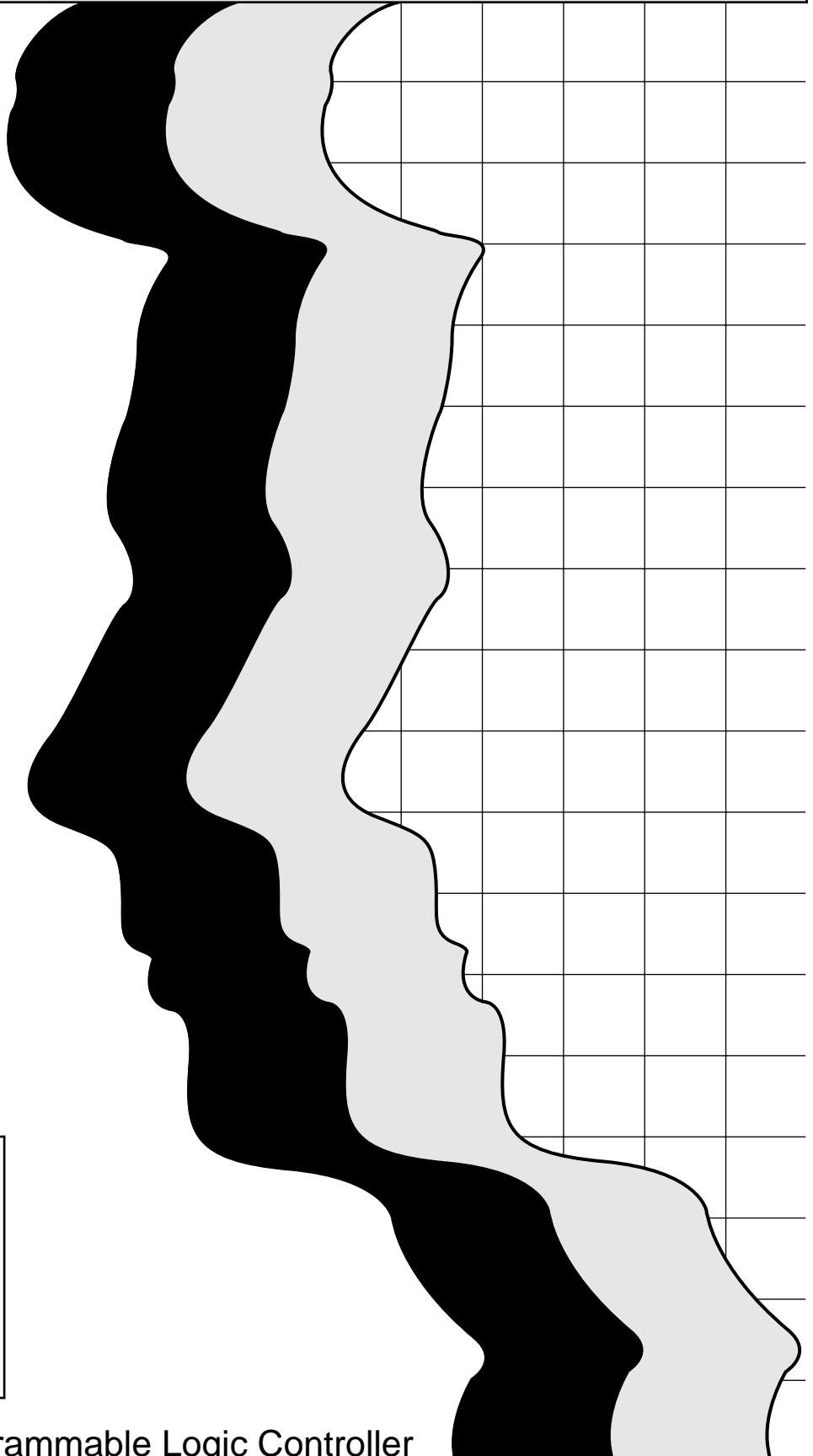

Mitsubishi Programmable Logic Controller



# ● SAFETY PRECAUTIONS ●

(Read these precautions before using.)

When using Mitsubishi equipment, thoroughly read this manual and the associated manuals introduced in the manual. Also pay careful attention to safety and handle the module properly.

These precautions apply only to Mitsubishi equipment. Refer to the CPU module user's manual for a description of the PLC system safety precautions.

These ● SAFETY PRECAUTIONS ● classify the safety precautions into two categories: "DANGER" and "CAUTION".

 <b>DANGER</b>	<b>Procedures which may lead to a dangerous condition and cause death or serious injury if not carried out properly.</b>
 <b>CAUTION</b>	<b>Procedures which may lead to a dangerous condition and cause superficial to medium injury, or physical damage only, if not carried out properly.</b>

Depending on circumstances, procedures indicated by  **CAUTION** may also be linked to serious results.

In any case, it is important to follow the directions for usage.

Store this manual in a safe place so that you can take it out and read it whenever necessary. Always forward it to the end user.

## [DESIGN PRECAUTIONS]

### **DANGER**

- In case of the external power supply failure or the programmable controller (PLC) failure, set up a safety circuit outside the PLC so that the entire system can operate safely. The mis-output and malfunction may cause an accident.

### **CAUTION**

- Use the PLC in an environment that meets the general specifications contained in this manual. Using this PLC in an environment outside the range of the general specifications could result in electric shock, fires, malfunctions, and damage to or deterioration of the product.
- Do not bunch the control wires with the main circuit or power wires, or install them close to each other. They should be installed 100 mm (3.94 inch) or more from each other. Failure to do so may result in noise that would cause malfunctions.

## [INSTALLATION PRECAUTIONS]

### CAUTION

- Insert the tabs at the bottom of the module into the mounting holes in the base unit and then install the module. If the module is not properly installed, it may result in malfunctions, failure, or fallout.
- Do not directly touch the module's conductive parts. Doing so could cause malfunctions or failure in the module.

## [WIRING PRECAUTIONS]

### CAUTION

- Ground the AG and FG terminals to the protected grounding conductor when there are a lot of noise. Failure to ground these terminals may cause malfunctions.
- When wiring PLC, check the rated voltage and terminal layout of the wiring and make sure the wiring is done correctly. Connecting a power supply that differs from the rated voltage or wiring it incorrectly may cause fires or failure.
- Tighten the terminal screws within the range of specified torque.  
If the terminal screws are loose, it may result in short circuits or malfunctions.  
Tightening the screws too far may cause damage to the screw, resulting in short circuits, or malfunctions.
- Be sure there are no foreign substances such as sawdust or wiring debris inside the module. Such debris could cause fires, failure, malfunctions.

## [STARTING AND MAINTENANCE PRECAUTIONS]

### DANGER

- Do not touch the connector while the power is on. Doing so could cause malfunctions.
- Make sure to switch all phases of the external power supply off before cleaning or re-tightening the terminal screws.  
If you do not switch off the external power supply, it will cause failure or malfunctions of the module.
- Do not disassemble or modify the modules. Doing so could cause failure, malfunctions, injury, or fires.
- Make sure to switch all phases of the external power supply off before mounting or removing the module. If you do not switch off the external power supply, it will cause failure or malfunctions of the module.

## [OPERATING PRECAUTIONS]

### DANGER

- Do not output (turn ON) the "usage disable" signal as an output to special modules from the PLC CPU.
- Outputting the "usage disable" signal may cause PLC system malfunctions.

## [DISPOSAL PRECAUTIONS]

### CAUTION

- When disposing of this product, treat it as industrial waste.

# Revisions

\* The manual number is noted at the lower left of the back cover.

Print Date	*Manual Number	Revision
Nov. 1998	SH(NA)-4009-A	First printing

This manual does not imply guarantee or implementation right for industrial ownership or implementation of other rights. Mitsubishi Electric Corporation is not responsible for industrial ownership problems caused by use of the contents of this manual.



## Introduction

Thank you for purchasing the Mitsubishi Graphic Operation Terminal.

Before using the equipment, please read this manual carefully to develop full familiarity with the functions and performance of the graphic operation terminal you have purchased, so as to ensure correct use.

Please forward a copy of this manual to the end user.

## Table of Contents

<b>1. OVERVIEW</b>	<b>1-1 to 1-2</b>
1.1 Differences between the A68AD-S2 and A68AD .....	1- 2
<b>2. SYSTEM CONFIGURATION</b>	<b>2-1</b>
<b>3. SPECIFICATIONS</b>	<b>3-1 to 3-13</b>
3.1 General Specification .....	3- 1
3.2 Performance Specifications .....	3- 2
3.2.1 Specifications .....	3- 2
3.2.2 I/O conversion characteristics .....	3- 3
3.2.3 Digital I/O system.....	3- 7
3.3 I/O List with Respect to Programmable Controller CPU .....	3-10
3.4 Buffer Memory .....	3-11
3.4.1 Assignment of buffer memory.....	3-11
3.4.2 Contents and data configuration of buffer memory.....	3-12
<b>4. HANDLING</b>	<b>4-1 to 4-3</b>
4.1 Handling Instructions .....	4- 1
4.2 Part Identification and Settings .....	4- 2
4.3 Wiring.....	4- 3
4.3.1 Wiring instructions .....	4- 3
4.3.2 Module connection example .....	4- 3
4.4 Maintenance and Inspection.....	4- 3
<b>5. PROGRAMMING</b>	<b>5-1 to 5-9</b>
5.1 Program Preparing Precautions.....	5- 1
5.1.1 Initial Setting .....	5- 1
5.1.2 Details of processing performed when use-channel specification is written.....	5- 3
5.2 Programming Instructions .....	5- 3
5.2.1 Specification of the use-channel.....	5- 3
5.2.2 Setting of averaging time or averaging count .....	5- 4
5.2.3 Averaging processing specification .....	5- 4
5.2.4 Read of digital output value .....	5- 4
5.2.5 Read and reset of write data error code .....	5- 5
5.2.6 Read of A/D conversion end flag .....	5- 6
5.2.7 Application circuit examples .....	5- 8

<b>6. TEST OPERATION AND CALIBRATION</b>	<b>6-1 to 6-2</b>
--	-------------------

6.1 Offset/Gain Setting.....	6- 1
6.2 Checks before Starting .....	6- 2

<b>7. TROUBLESHOOTING</b>	<b>7-1 to 7-6</b>
---------------------------	-------------------

7.1 Write Data Error Code List.....	7- 1
7.2 Troubleshooting .....	7- 2
7.2.1 Troubleshooting flow chart.....	7- 2
7.2.2 Flow chart used when "RUN" LED has flickered .....	7- 3
7.2.3 Flow chart used when "RUN" LED has turned off.....	7- 4
7.2.4 Flow chart used when digital output value cannot be read.....	7- 5
7.2.5 Flow chart used when data, such as the use-channels, cannot be written.....	7- 6

<b>APPENDIX</b>	<b>A-1 to A-2</b>
-----------------	-------------------

Appendix 1 Precautions to be Taken to Replace the A68AD with the A68AD-S2 .....	A- 1
Appendix 2 External Dimensions .....	A- 2

# 1. OVERVIEW

This User Manual describes the specifications, handling and programming methods for the A68AD-S2 analog-digital conversion module (hereinafter referred to as the A68AD-S2), which is used in conjunction with MELSEC-A Series CPU modules (hereinafter referred to as the PC CPU). The A68AD-S2 is a module that converts analog signals (voltage or current input) sent from outside the PC into digital values in the form of 16-bit signed BIN data.

In this manual, CPU model names are generically referred to as the following:

PC CPU	Building block type CPU	A1NCPU(P21/R21), A2NCPU(P21/R21), A2NCPU(P21/R21)-S1, A3NCPU(P21/R21), A1CPU(P21/R21), A2CPU(P21/R21), A2CPU(P21/R21)-S1, A3CPU(P21/R21), A3HCPU(P21/R21), A3MCPU(P21/R21), A2ACPU(P21/R21), A2ACPU(P21/R21)-S1, A3ACPU(P21/R21), A2UCPU, A2UCPU-S1, A3UCPU, A4UCPU, Q2ACPU(S1), Q3ACPU, Q4ACPU, Q4ARCPU
	Compact-type CPU	A0J2CPU(P23/R23), A0J2HCPU(P21/R21)

## POINT

The A68AD-S2's I/O addresses indicated in this manual assume that a building block type CPU is used and the A68AD-S2 is installed in Slot 0 of the basic base unit.

When the A68AD-S2 is installed to other than Slot 0 or when a compact-type CPU is used, use the I/O addresses assigned to the A68AD-S2 for programming.



## 1.1 Differences between the A68AD-S2 and A68AD

The major differences between the A68AD-S2 and the A68AD are listed below.

Item \ Model	A68AD-S2	A68AD
Method for specifying the A/D conversion channel	Set "Yes" or "No" for A/D conversion channel by channel (refer to Section 5.2.1)	Set the sequential number of channels, beginning with channel 1.
Timing for specifying the A/D conversion channel	Channels can be specified even during A/D conversion (refer to Section 5.1)	The number of channels can be specified once upon power on.
A/D conversion end flag	With the A/D conversion specification changed from "No" to "Yes," digital values are entered in the buffer memory upon completion of A/D conversion and then the A/D conversion end flag is set (refer to Section 5.2.6)	None

## 2. SYSTEM CONFIGURATION

(1) Applicable CPU models

- A0J2CPU(P23/R23)
- A1CPU(P21/R21)
- A2NCPU(P21/R21)-S1
- A3CPU(P21/R21)
- A2ACPU(P21/R21)
- A2UCPU(S1)
- Q2ACPU(S1)
- A0J2HCPU(P21/R21)
- A2NCPU(P21/R21)
- A2CPU(P21/R21)-S1
- A3HCPU(P21/R21)
- A2ACPU(P21/R21)-S1
- A3UCPU
- Q3ACPU
- A1NCPU(P21/R21)
- A2CPU(P21/R21)
- A3NCPU(P21/R21)
- A3MCPUCPU(P21/R21)
- A3ACPU(P21/R21)
- A4UCPU
- Q4ACPU
- Q4ARCPU

(2) Number of modules loaded

There is no limit in the number of modules loaded, as long as the number of I/O points is within the range allowed for the CPU used.

(3) Slots used for module loading

The module can be loaded to any slot in the base unit, except for when the module is installed to an extension base unit not equipped with a power supply module (A52B, A55B, A58B). In this case, the power capacity may become insufficient.

When installing the A68AD-S2 module to such extension base unit, consider the following items carefully when selecting the power supply module, basic base unit, extension base unit and extension cable:

- ① Current capacity in the power supply module for the basic base unit
- ② Voltage drops in the basic base unit
- ③ Voltage drops in the extension base unit
- ④ Voltage drops in the extension cable

(4) Data link system

In a data link system, the module can be installed to the master station, local station or remote I/O station. Refer to the MELSECNET or MELSECNET/B Data Link System Reference Manual for program examples in a remote I/O station.

**Remarks**

For the information on the range of I/O points and calculation method for voltage drops, refer to the User Manual (Details) for the CPU used.

## 3. SPECIFICATIONS

This section explains the A68AD-S2 the general specifications, performance specifications and I/O signals.

### 3.1 General Specification

This section explain the A68AD-S2 general specifications.

Table 3.1 General specification

Item	Specification					
Usage ambient temperature	0 to 55°C					
Storage ambient temperature	-20 to 75°C					
Usage ambient humidity	10 to 90%RH, no condensation					
Storage ambient humidity	10 to 90%RH, no condensation					
Vibration durability	Conforming to JIS B 3501, IEC 1131-2	When there is intermittent vibration	Frequency	Acceleration	Amplitude	Sweep count 10 times in each direction X, Y, Z (80 minutes)
			10 to 57Hz	—	0.075mm (0.0030inch)	
		When there is continuous vibration	57 to 150Hz	9.8m/s <sup>2</sup> {1G}	—	
			10 to 57Hz	—	0.035mm (0.0013inch)	
57 to 150Hz	4.9m/s <sup>2</sup> {0.5G}	—				
Shock durability	Conforming to JIS B 3501, IEC1131-2 (147m/s <sup>2</sup> {15G}, 3 times each in 3 directions)					
Usage environment	No corrosive gas					
Usage height	Less than 2000 m (less than 6562 ft.)					
Installation area	Within the control board					
Over-voltage category <sup>1</sup>	Less than II					
Pollution level <sup>2</sup>	Less than 2					

\*1 Indicates the location where the device is connected from the public cable network to the device structure wiring area.

Category II applies to the devices to which the power is supplied from a fixed equipment. Surge withstand voltage for devices with up to 300V of rated voltage is 2500V.

\*2 This is an index which indicates the degree of conductive object generation in the environment. Pollution level 2 is when only non-conductive pollution occurs.

A temporary conductivity caused by condensation must be expected occasionally.

## 3.2 Performance Specifications

### 3.2.1 Specifications

Item	Specifications												
Analog input	Selection depends on input terminals. Voltage: -10 to 0 to +10V DC (Input resistance: 1M $\Omega$ ) Current: +4 to +20mA DC (Input resistance: 250 $\Omega$ ) *-20 to 0 to +20mA can also be used for current Input.												
Digital output	A CPU: 16-bit, signed binary (-2048 to +2047)												
I/O characteristics	<table border="1"> <thead> <tr> <th>Analog Input</th> <th>Digital Output</th> </tr> </thead> <tbody> <tr> <td>+10V</td> <td>+2000</td> </tr> <tr> <td>+5V or +20mA</td> <td>+1000</td> </tr> <tr> <td>0V or +4mA</td> <td><math>\pm 0</math></td> </tr> <tr> <td>-5V or -12mA</td> <td>-1000</td> </tr> <tr> <td>-10V</td> <td>-2000</td> </tr> </tbody> </table>	Analog Input	Digital Output	+10V	+2000	+5V or +20mA	+1000	0V or +4mA	$\pm 0$	-5V or -12mA	-1000	-10V	-2000
Analog Input	Digital Output												
+10V	+2000												
+5V or +20mA	+1000												
0V or +4mA	$\pm 0$												
-5V or -12mA	-1000												
-10V	-2000												
Maximum resolution	Voltage: 5mV (1/2000) Current: 20 $\mu$ A (1/1000)												
Overall accuracy	Within $\pm 1\%$ (Accuracy with respect to the maximum value)												
Maximum conversion speed	Maximum 2.5ms/channel												
Absolute maximum input	Voltage: $\pm 15$ V Current: $\pm 30$ mA												
Number of analog input points	8 channels/module												
Insulation method	Photocoupler insulation between output terminals and PC power (Non-insulated between channels)												
Number of I/O points	32 points												
Connection terminal	38-point terminal block												
Applicable wire size	0.75 to 2mm <sup>2</sup> (Applicable tightening torque: 7kgf·cm)												
Applicable solderless terminal	V1.25-3, V1.25-YS3A, V2-S3, V2-YS3A												
Internal current consumption (5V)	0.39A												
Weight	0.3kg (0.66lb)												

Table 3.2 Performance Specifications

POINT
Analog input allowed for maximum resolution and overall accuracy, is from -10 to 0 to +10V or from -20 to 0 to +20mA.

**Remarks**

The following specifications are different for the A68AD-S2 modules whose hardware versions are J or earlier.

Item	Specification
Analog input	Voltage: DC -10 to 0 to +10 V (input resistance 30 kΩ) Current: DC +4 to +20 mA (input resistance 250 Ω) } User either of these by selecting via the input terminal.
Internal current consumption(5V)	0.9A
Weight	0.6 kg (1.32 lb.)

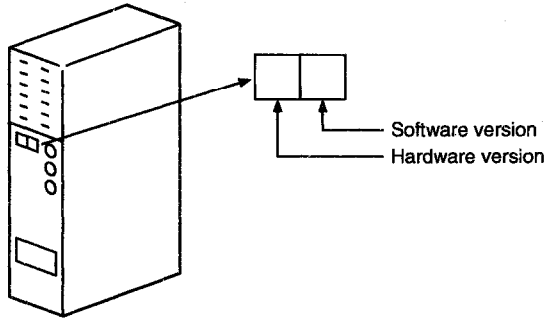

**3.2.2 I/O conversion characteristics**

I/O conversion characteristics are dictated by the offset value and gain value set in test mode. Fig. 3.1 shows an example for voltage input.

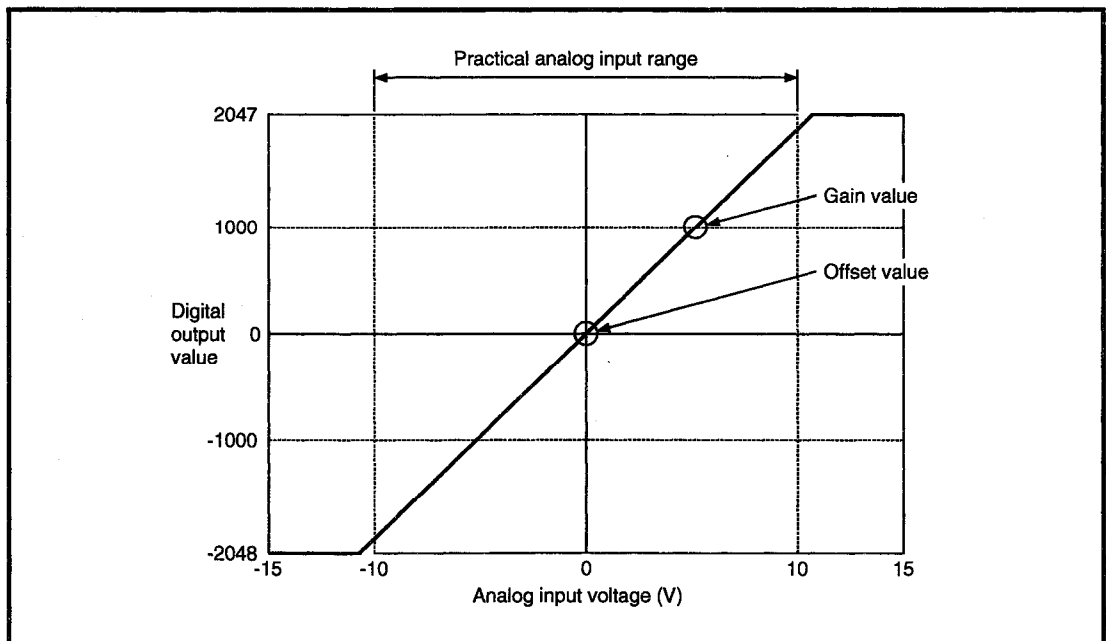

Fig. 3.1 I/O Conversion Characteristic

**Remarks**

1. The offset value is the analog input (voltage or current) value at which the digital output value is 0. Set the offset value in test mode.
2. The gain value is the analog input (voltage or current) value at which the digital output value is 1000. Set the gain value in test mode.

## (1) Voltage input characteristic

Fig. 3.2 shows the voltage characteristics for three different offset/gain combinations.

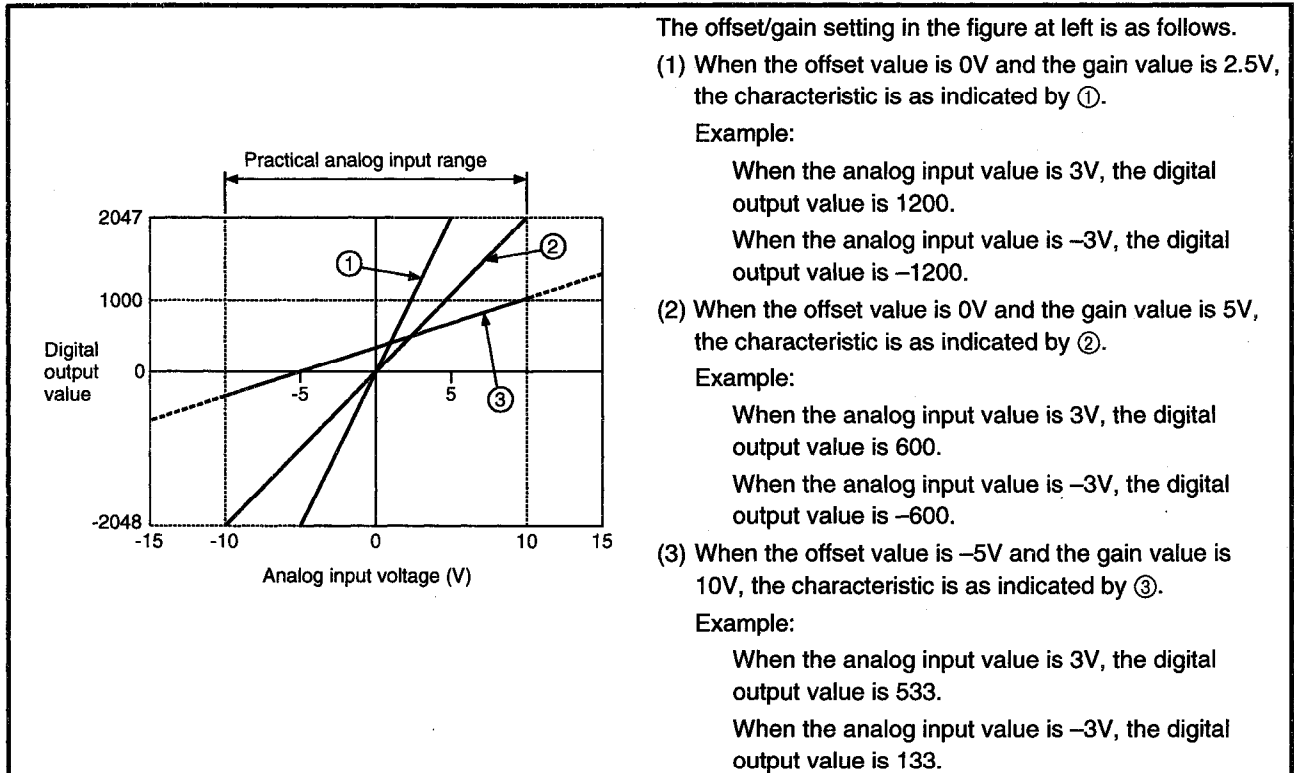

Fig. 3.2 Voltage Input Characteristic

<b>POINT</b>
--------------

1. When the input voltage is in the range from -10 to 0 to +10V, the maximum resolution and overall accuracy are within the quoted range of performance specifications. However, if this range is exceeded, resolution and accuracy will be impaired.
2. If an analog input corresponding to a digital output value of more than +2047 is applied, the digital output value will not exceed +2047.
3. Do not apply  $\pm 15V$  or more. This will damage the module.
4. In offset/gain setting, the offset value should always be less than the gain value. If the offset value is greater than or equal to the gain value, the digital output value will be unpredictable.

## (2) Current input characteristic

Fig. 3.3 shows the current characteristics for two different offset/gain combinations.

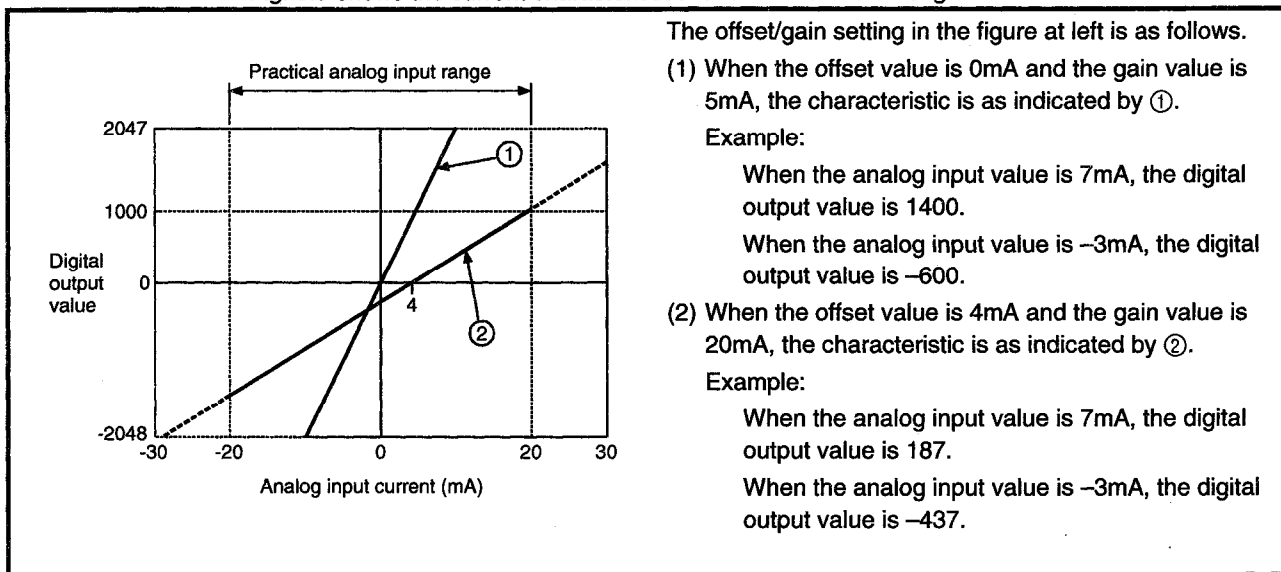

Fig. 3.3 Current Input Characteristic

<b>POINT</b>
--------------

1. When the input current is in the range from -20 to 0 to +20mA, the maximum resolution and overall accuracy are within the quoted range of performance specifications. However, if this range is exceeded, resolution and accuracy will be impaired.
2. If an analog input, corresponding to a digital output value of more than +2047 is applied, the digital output value will not exceed +2047.
3. Do not apply  $\pm 30\text{mA}$  or more. This will damage the module.
4. In offset/gain setting, the offset value should always be less than the gain value. If the offset value is greater than or equal to the gain value, the digital output value will be unpredictable.

## (3) Relation between offset/gain setting and digital output value

The maximum resolution of the A68AD-S2 is 5mV in voltage and 20 $\mu\text{A}$  in current. Maximum resolution may be found using the following expression:

$$\frac{(\text{Gain value}) - (\text{offset value})}{1000} < (\text{maximum resolution})$$

Fig. 3.4 and 3.5 show the relation between the offset/gain setting and the digital output value for the offset/gain settings in Fig. 3.2 and 3.3.

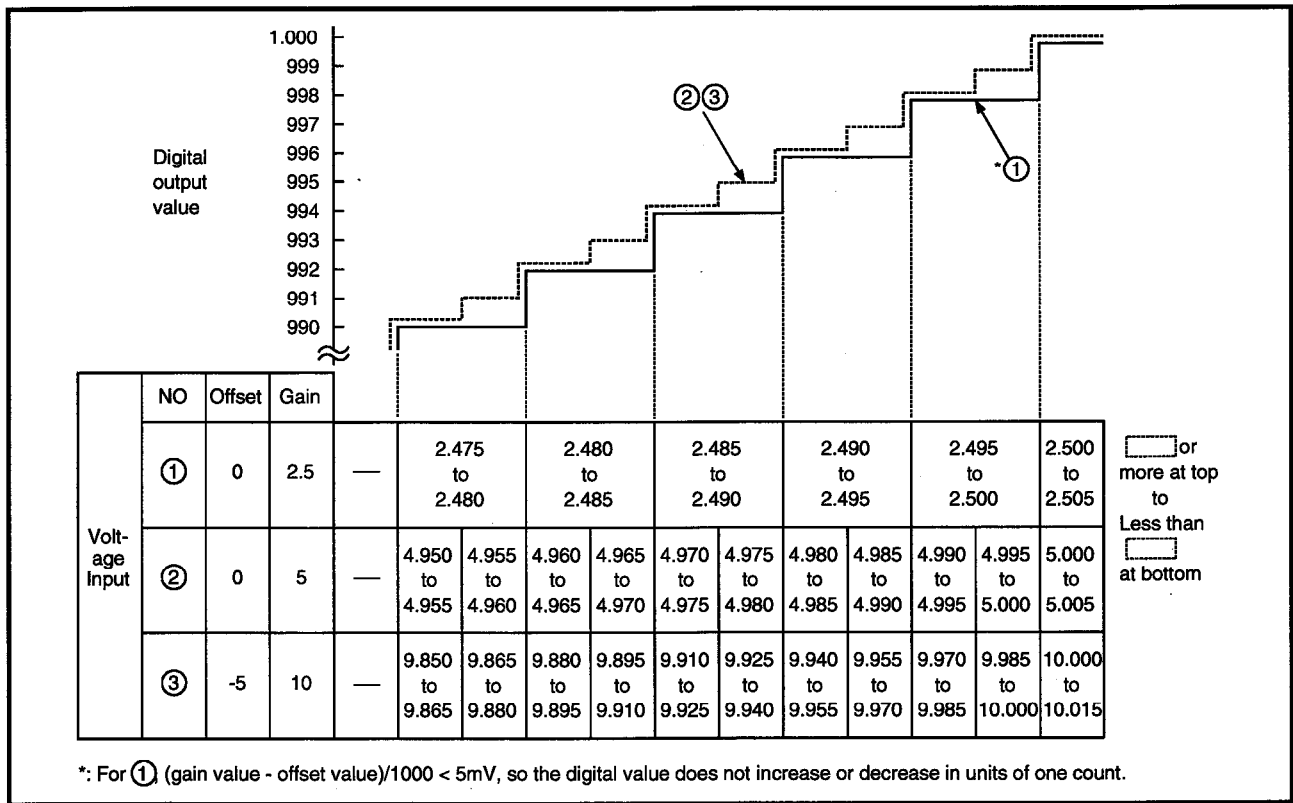

Fig. 3.4 Voltage Input and Digital Output Value

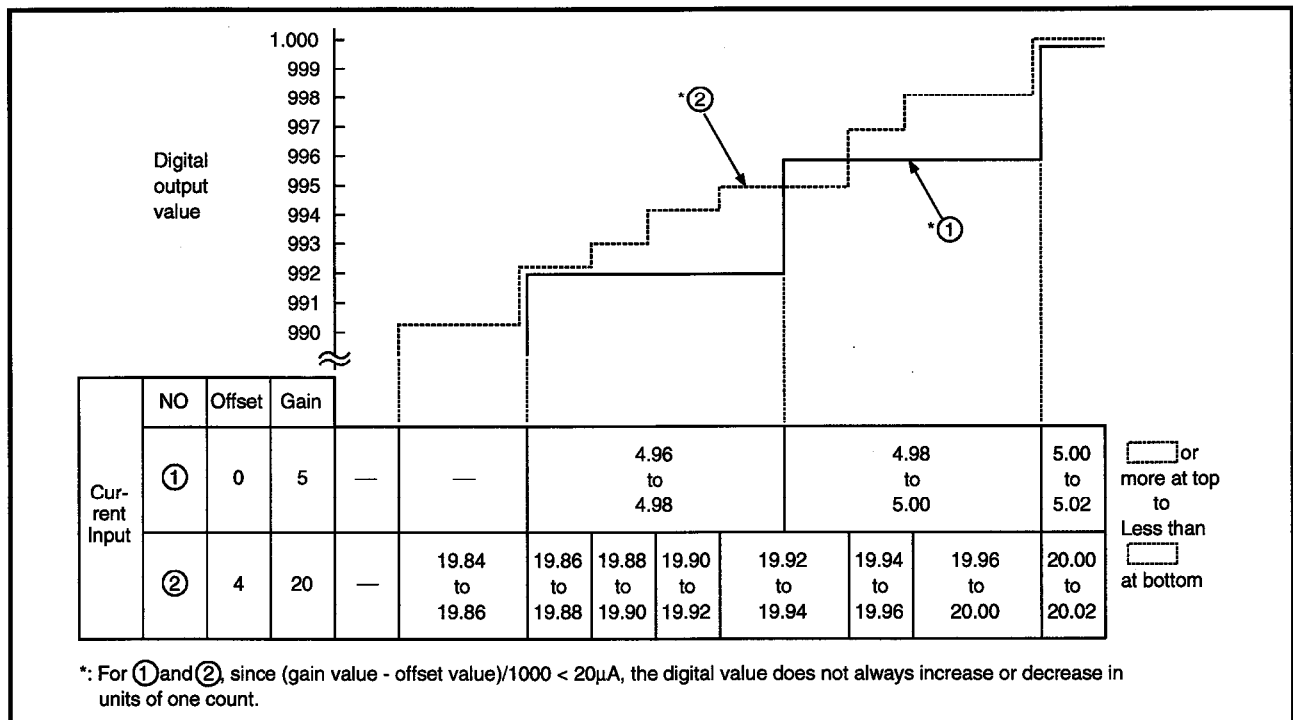

Fig. 3.5 Current Input and Digital Output Value



### 3.2.3 Digital I/O system

The digital output value of the A68AD-S2 is determined by the following:

(1) I/O conversion characteristics:

- ┌ Offset value
- └ Gain value

The digital output value depends on the offset value and gain value which have been set in test mode.

(2) A/D conversion system:

- ┌ Sampling processing
- └ Averaging processing ─┬─ Averaging processing in terms of count .... 1 to 4000 times
- └─ Averaging processing in terms of time ..... 20 to 10000ms

1) Sampling processing

The analog input values are converted to digital output values one by one and the digital output values are stored in the buffer memory.

2) Averaging processing

The A68AD-S2 makes the A/D conversion for any channels to which averaging processing has been specified from the programmable controller CPU. Using a preset count or a preset period of time, an average is calculated (excluding the maximum value and the minimum value,) and stored to the buffer memory. If the processing count is specified as two or less, sampling processing is applied.

Averaging processing is initialized when the use-channel is specified (at address 0 of the buffer memory). For further details, refer to Section 5.1.2.

**POINT**

The A68AD-S2 may sample data in any one of three ways. These sampling methods can be applied separately to any channel. The sampling process is controlled by the A68AD's own CPU, but must be specified from the programmable controller CPU. (This is fully explained in section 3.4.1)

**Method 1**

**Sampling Processing:** This is the most commonly used sampling procedure. As the A68AD-S2's CPU scans each channel, the value appearing at that instant is written to the buffer memory as a digital value. The timing of this sampling depends on the number of channels used, and may be found from the following expression:

$$(\text{Processing time}) = (\text{Number of channels used}) \times 2.5 \text{ (ms/channel)}$$

(Where the maximum conversion speed is taken as 2.5ms/channel)

Example 1: Number of channels = 5

$$\text{Processing time} = 5 \times 2.5\text{ms} = 12.5\text{ms}$$

**Method 2**

**Averaging processing by specifying time:** In this case the CPU takes a number of samples of the data at each channel and then calculates the average value over the specified time period. The number of samples taken depends on the number of channels and the time setting. It is calculated as follows:

$$(\text{Processing count}) = \frac{(\text{Time setting})}{(\text{Number of channels}) \times 2.5\text{ms}} \text{-(I)}$$

Example 2: Time setting = 1000ms, 4 channels

$$(\text{Processing count}) = \frac{1000}{4 \times 2.5} = 100 \text{ samples.}$$

(Where maximum conversion speed = 2.5ms/channel)

**Method 3**

**Averaging processing by specifying a number of counts:** This is similar to method 2 except that in this case the number of samples for the averaging process is specified. The processing time may be found from the following expression:

$$(\text{Processing time}) = (\text{Count setting}) \times (\text{Number of channels}) \times 2.5\text{ms}$$

Example 3: Count setting = 500, 4 channels

$$(\text{Processing time}) = 500 \times 4 \times 2.5 = 5000\text{ms} \text{ -(II)}$$

(Where maximum conversion speed = 2.5ms/channel)

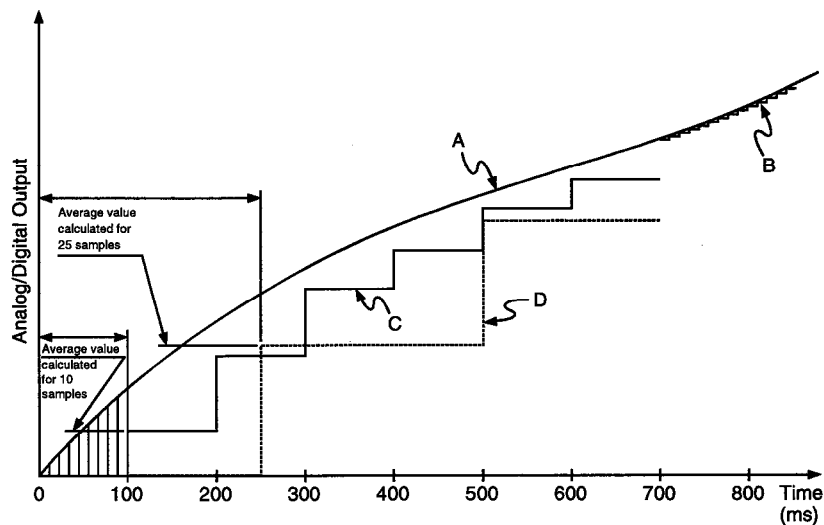

Fig. 3.6

Graph showing variations between output values for different sampling methods.

Referring to the graph in Fig. 3.6

Trace A represents a steadily rising analog input signal.

Trace B represents the digital output obtained when method 1, sampling processing, is used. In this case the output value would be susceptible to variations due to any noise present on the analog signal.

Trace C represents the digital output obtained when time based averaging is used. In this case the number of channels was taken as 4 and the sampling time as 100ms.

Hence the processing count (from equation I) is:

$$\frac{100}{4 \times 2.5} = 10 \text{ samples}$$

10 samples are therefore taken every 100ms and an average calculated. This average is then output as a digital value while the CPU takes the next 10 samples.

Note that the allowable time setting range is 20 → 10000ms which is equivalent to 2 → 1000 samples (with 4 channels).

Trace D represents the digital output obtained when count based averaging is used.

Again, the number of channels was taken as 4, the count setting was 25, the processing time, from equation II is

$$25 \times 4 \times 2.5 = 250\text{ms}$$

One sample is therefore taken every 10ms, and after 25 samples have been taken, the average value is used for the digital output while the next 250 are being sampled.

Note that the allowable count setting range is 1 → 4000 which is equivalent to 40 → 40000ms (with 4 channels).

### 3.3 I/O List with Respect to Programmable Controller CPU

The I/O signals of the A68AD-S2 with respect to a programmable controller CPU are as indicated below. Numbers for X and Y are determined by the slot occupied by the A68AD-S2 and the number of points of the other I/O units.

The I/O numbers indicated below are used when the A68AD-S2 module is loaded into slot No. 0 of the main base unit.

(1) Input signals with respect to programmable controller CPU, 32 points from X0 to 1F.

Input Signal	Description
X0	Watch dog timer error Turns on if a watch dog timer error occurs in the A68AD-S2.
X1	A/D conversion ready (1) Turns on when A/D conversion is ready (not in test mode) after the power is turned on or the programmable controller CPU is reset. Turns off in test mode. (2) Used as an interlock when read or write is performed from the programmable controller CPU to the A68AD-S2.
X2 to X1F	Not used (X1D to 1F are used when remote I/O)

#### Remarks

A/D conversion ready indicates that a digital output value has been stored into the buffer memory after the A/D conversion of all eight channels has been completed.

(2) Output signals with respect to programmable controller CPU, 32 points from Y0 to 1F.

Output Signal	Description
Y0 to Y1F	Not used

#### Important

Outputs Y0 to Y1F are reserved, they should not be used in the sequence program.

If the A68AD-S2 is used in a remote I/O rack, however, inputs Y0E and Y0F may be set and reset in the sequence program to allow "hand shaking" with the CPU.

### 3.4 Buffer Memory

The A68AD-S2 is equipped with a buffer memory (which is not battery backed) for the communication of data with a programmable controller CPU. Explanation will be given for the assignment and data configuration of this buffer memory.

For the read and write operation procedures by the sequence program, refer to Chapter 5.

#### 3.4.1 Assignment of buffer memory

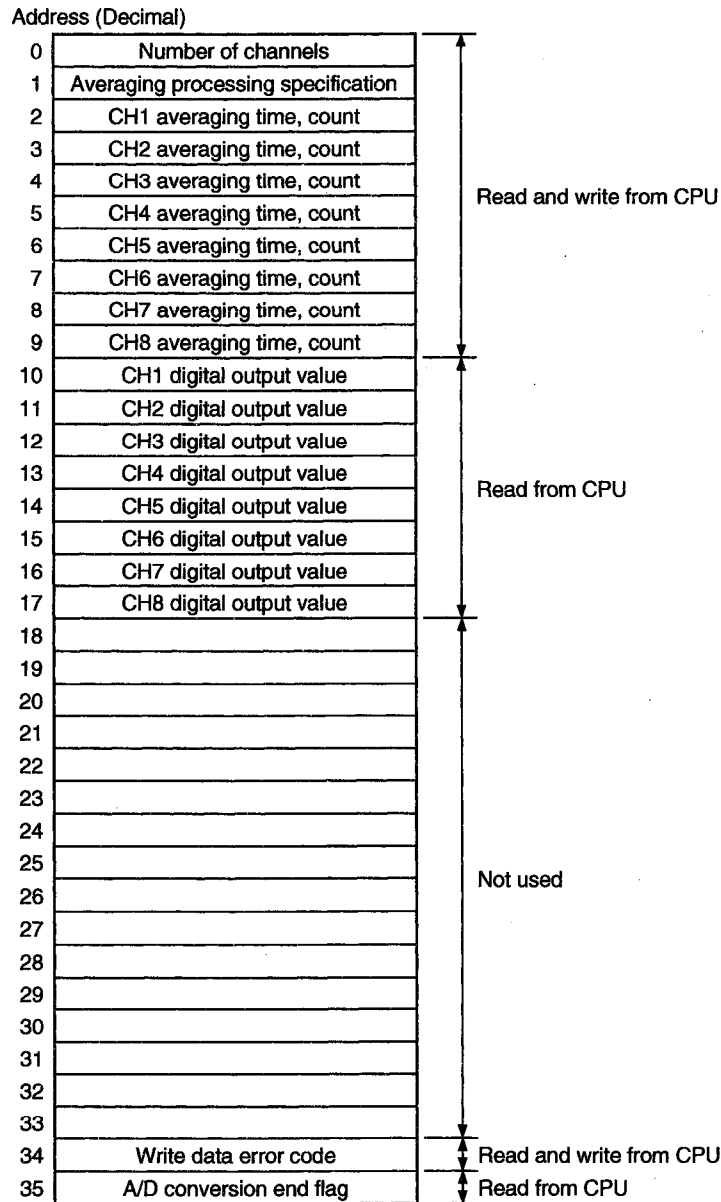

※ All 16-bit data.

<b>Point</b>	The addresses 10 to 33 of buffer memory are areas exclusively used for reading from a programmable controller CPU. Writing to these addresses will cause mis operation.
--------------	---

**3.4.2 Contents and data configuration of buffer memory**

This section describes the contents and data configuration of buffer memory for each item.

(1) Specification of the use-channels (Address 0)

- a) Specify the channels for which A/D conversion processing is required by channels.

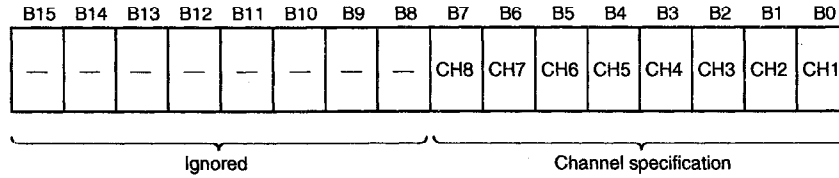

1: A/D conversion required  
0: A/D conversion not required

- b) In order to reduce sampling time, the use-channel specification can be changed by the sequence program. (For details, refer to Section 5.2.1)
- c) When the power is turned on, 00FF<sub>H</sub> (225) which specifies A/D conversion for all the channels is set.

Example:

To specify channels 1, 3, and 4 only are for A/D conversion. Sampling time can be set to 7.5 ms by entering 000D<sub>H</sub> (13) for specifying the channels to be used.

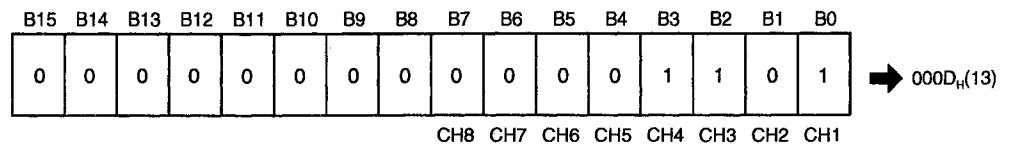

(2) Averaging processing specification (Address 1)

- a) When the power is turned on and the A/D conversion ready signal of A68AD-S2 is on, all channels are set to sampling processing.
- b) For selection of sampling processing or averaging processing use address 1 of the buffer memory.

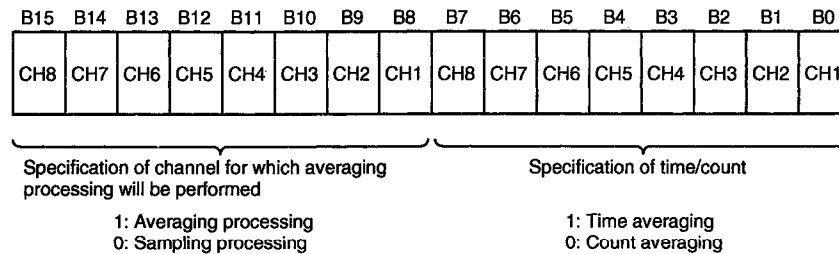

**Point**

When averaging processing is not specified, sampling processing is set without regard to the specification of time/count.

(3) Averaging time, averaging count (Addresses 2 to 9)

- a) At power-on, the averaging time and averaging count are set to 0.
- b) The setting ranges are as indicated below:  
 Averaging processing in terms of count: 1 to 4000 times  
 Averaging processing in terms of time: 20 to 10000ms

**Point**

If a value outside the above range has been written, setting error occurs and the buffer memory is rewritten. However, the A68AD performs A/D conversion processing at the averaging time or count previously set.

- (4) Digital output value (Addresses 10 to 17)  
 The digital output value is expressed in 16-bit, signed binary within the range from -2048 to +2047.

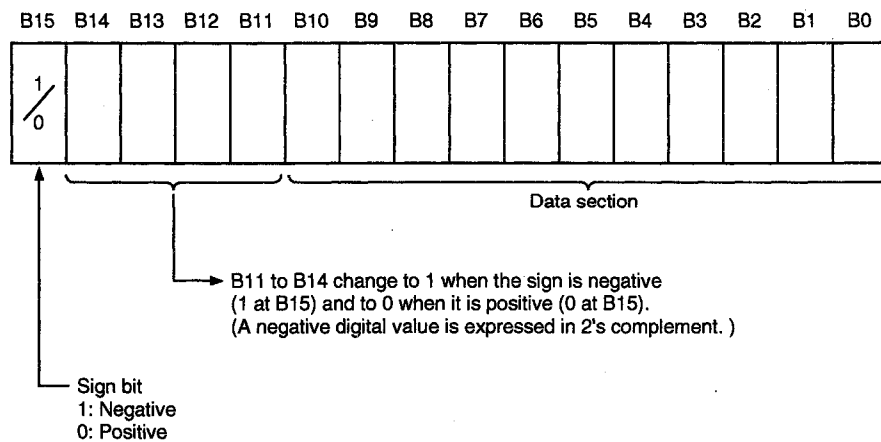

- (5) Write data error code (Address 34)
- a) When data is read from the programmable controller CPU, the A68AD-S2 makes a data range check for the number of channels used once only. When one of the values is outside the range, the A68AD-S2 sets an error code in 16-bit binary. For details of error codes, refer to Section 7.1.
  - b) To reset an error code, write 0 from the programmable controller CPU.
  - c) When several error codes have occurred, the data error code, which has been detected by the A68AD-S2 first, is stored. The other errors are not stored.
  - d) If an error is reset without remedying the error, the data error code is set to 0 and the RUN LED of A68AD-S2 stops flickering (Section 4.2).
- (6) A/D conversion end flag (Address 35)
- a) The A/D conversion end flag is processed once when the setting for address 0, where A/D conversion channels are specified, is changed.
    - When the specification of the use-channel is changed from 0 to 1:  
 The A/D conversion end flag for the relevant channels is changed to 1.
    - When the specification of the use-channel is changed from 1 to 0:  
 The A/D conversion end flag for the relevant channel is changed to 0.
  - b) The A/D conversion end flag is provided for each channel.

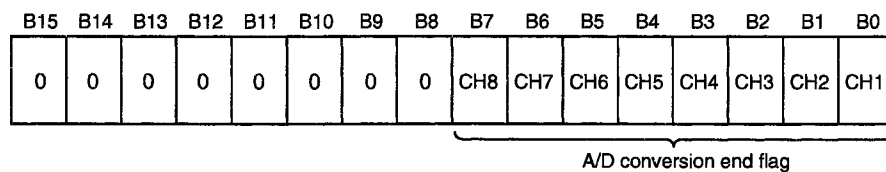

1: A/D conversion end  
 0: A/D conversion incomplete

- c) With averaging processing specified, the A/D conversion end flag is changed to 1 after digital values that have been obtained by averaging processing of averaging count or time is stored in the buffer memory.  
 For example, when 10 counts are specified for averaging processing for channel 1, the average value obtained after 10 counts of A/D conversion is stored in the buffer memory and the A/D conversion end flag is changed to 1.
- d) By the time A/D conversion READY (X1) is turned ON after power-on, 00FFH(255) is stored since A/D conversion has been completed once for channels 1 to 8.
- e) The A/D conversion end flag can be used as an interlock to read the digital values of the channel for which averaging processing is specified. For further details, refer to Section 5.2.6.

## 4. HANDLING

This chapter describes the handling instructions, nomenclature, maintenance, and inspection of the A68AD-S2.

### 4.1 Handling Instructions

- (1) Protect the A68AD-S2 and its terminal block from impact.
- (2) Do not touch or remove the printed circuit board from the case.
- (3) When wiring, ensure that no wire offcuts enter the module and remove any that do enter.
- (4) Tighten terminal screws as specified below.

Screw	Tightening Torque Range N·cm (kgf·cm) [lb·inch]
Terminal block terminal screw (M3 screw)	39 to 59N·cm (4 to 6kgf·cm) [3.5 to 5.2lb·inch]
Terminal block installation screw (M4 screw)	78 to 118N·cm (8 to 12kgf·cm) [6.93 to 10.4lb·inch]

- (5) To load the module onto the base, press the module against the base so that the hook is securely locked. To unload the module, push the catch on the top of the module, and after the hook is disengaged from the base, pull the module toward you.



### 4.2 Part Identification and Settings

The following describes the part names and settings of the A68AD-S2.

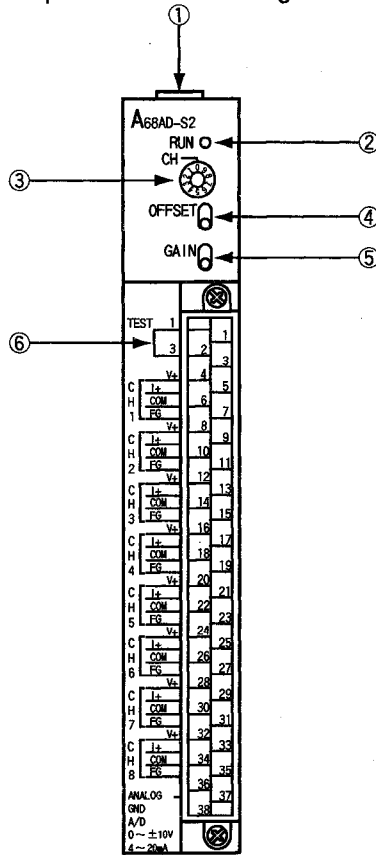

No.	Name	Description
①	Module fixing hook	Hook for fixing the A68AD-S2 to the base unit
②	RUN LED	Indicates the operating status of A68AD-S2. (Normal mode) ON: During normal operation Flicker: At write data error or A68AD-S2 hardware error OFF: 5V power off or watch dog timer error (Test mode) ON: When the OFFSET switch or GAIN switch is located at the ON position. OFF: When both the OFFSET switch or GAIN switch is located at the OFF position.
③	CHANNEL select switch	Used to select a channel for the offset adjustment and gain adjustment. (No processing at positions 0 and 9.)
④	OFFSET switch	At the ON position, stores the applied analog input value into the A68AD-S2 as an offset value.
⑤	GAIN switch	At the ON position, stores the applied analog input value into the A68AD-S2 as a gain value.
⑥	Test mode terminals	Prior to offset/gain setting, connect together terminals 1 and 3.

## 4.3 Wiring

### 4.3.1 Wiring instructions

Protect external wiring against noise with the following precautions:

- (1) Separate AC and DC wiring.
- (2) Separate main circuit and/or high voltage wiring from control and signal wiring.
- (3) Where applicable, ground the shielding of all wires to a common ground point.
- (4) With the A68AD-S2, the input terminal and PC power supply are insulated with photocopy, but no insulation is provided between channels. Observe the following points when one module uses multiple channels:
  - ① The COM terminals of analog inputs are internally connected. Have the voltage level or current level the same in all COM terminals.
  - ② If COM terminals have different levels of voltage or current, use a separate A68AD-S2 or perform analog input after providing inter-channel insulation externally.

### 4.3.2 Module connection example

- (1) Voltage input  
Signal source: 0 to  $\pm 10V$

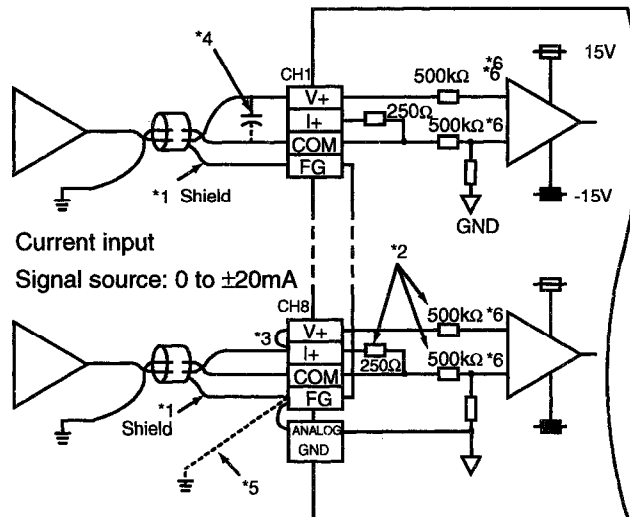

- (2) Current input

Signal source: 0 to  $\pm 20mA$

- \*1: For the cable, use a two-core twisted shielded wire.  
 \*2: Indicates the input resistance of the A68AD-S2.  
 \*3: For current input, be sure to connect the terminals (V+) and (I+).  
 \*4: If noise or ripple is generated at the external wiring, connect a capacitor of approximately 0.1 to 0.47 $\mu F$  between terminals V and COM.  
 \*5: If there is excessive noise, ground the module.  
 \*6: The resistance value is set to 15 k $\Omega$  for the A68AD-S2 with the hardware version of J or earlier.

#### POINT

- (1) The FG terminal of the A68AD-S2 and the FG terminal of the power supply module are not connected together internally.
- (2) When two or more channels are to be used for one module of the A68AD-S2, refer to Section 4.3.1.

## 4.4 Maintenance and Inspection

The A68AD-S2 requires no special maintenance or inspection. For general information see the A CPU User's Manual.

# 5. PROGRAMMING

## 5.1 Program Preparing Precautions

### 5.1.1 Initial Setting

Before analog to digital conversion begins it is necessary to write certain initial data to the buffer memory. This data consists of the averaging time or count and specification of the sampling method required (See section 3.4.1).

The most convenient way to write this data to the buffer memory is to use a single "TO" type instruction as shown in the example below:

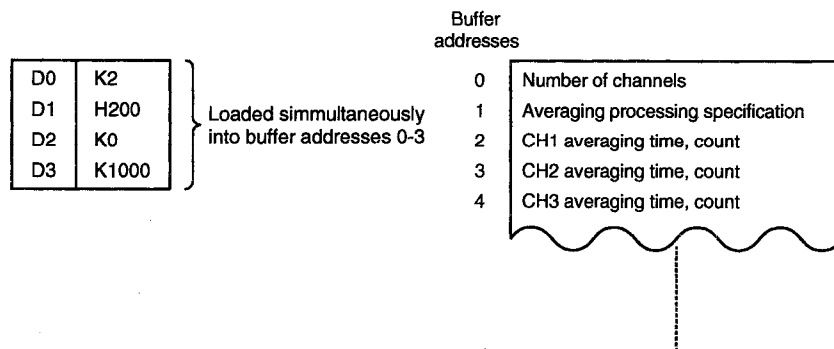
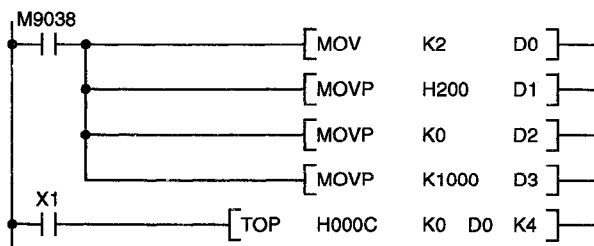

The above example sets the number of channels to 2 (i.e. D0), specifies channel 2 for count averaging (i.e. D1), and sets channel 2 count setting to 1000 (i.e. D3).

The A68AD-S2 is located in the main base in the slot with head element number X/Y C0.

The initial data may also be written using individual "TO" type instructions for each buffer address, in this case always execute in the following order:

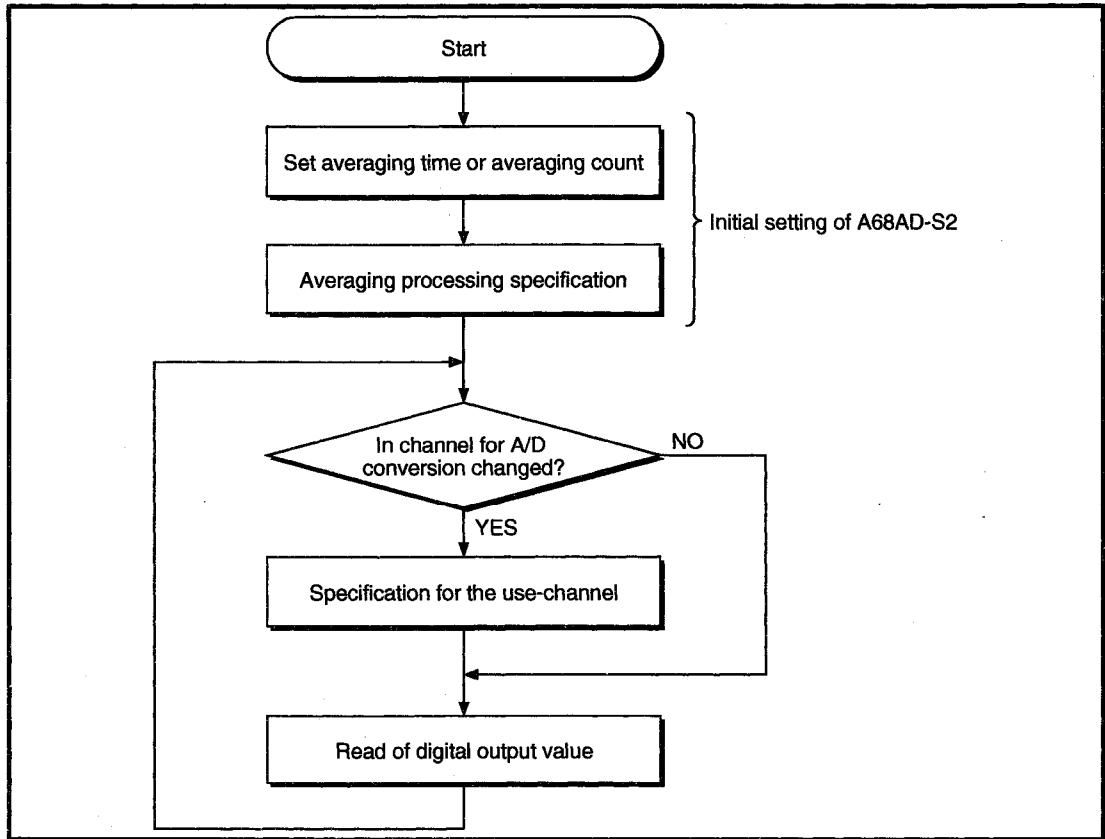
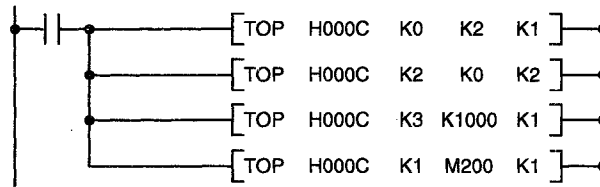

Fig. 5.1 Initial Setting Procedure

When this procedure is used, the previous example must be programmed as follows:



i.e. The count setting (K1000) is loaded into buffer address 3 before averaging processing specification, M200, is loaded into address 1. If this order is changed a write in error may occur. This will cause the run LED on the A68AD-S2 to flicker. Error status may also be found by monitoring buffer memory address 34.

This error occurs because the A68AD-S2 is normally in run mode. If averaging processing specification is made, the A68AD-S2 immediately looks for the relevant averaging data. If this data has not already been written to the module an error is registered.

**5.1.2 Details of processing performed when use-channel specification is written**

The following processing is performed when the use-channel specification is written.

- (1) Initialization of averaging processing  
 To perform averaging processing, the data stored in the A68AD-S2 (read from and write to the sequence program are prohibited) is initialized.  
 The digital values stored in the buffer memory remain the data that were present before the specification of the use-channel.  
 For example, when the use-channel specification is made for the channel for which the averaging processing using 50 samples were specified after completion of 30 sampling, the data obtained from 30 samplings is cleared and averaging processing proceeds starting from the initial state.
- (2) AD/ conversion end flag reset  
 The A/D conversion end flag (address 35 in the buffer memory) for channels 1 through 8 is reset.

**5.2 Programming Instructions**

This section describes the specification of the use-channel, the specification of averaging processing, read of digital output value and write error code, and application example. For further details of instructions, refer to the Programming Manual. When the module is used in a remote I/O station, refer to the Data Link User' Manual.

**5.2.1 Specification of the use-channel**

- (1) Set the A/D conversion channels at address 0 of the buffer memory.
- (2) The use-channel can be specified channel by channel.
- (3) When the specification of the use-channel is written, averaging processing data is initialized and the A/D conversion end flag is reset. For further details, refer to Section 5.1.2.
- (4) Program example  
 To carry out A/D conversion at channels 3 and 5.

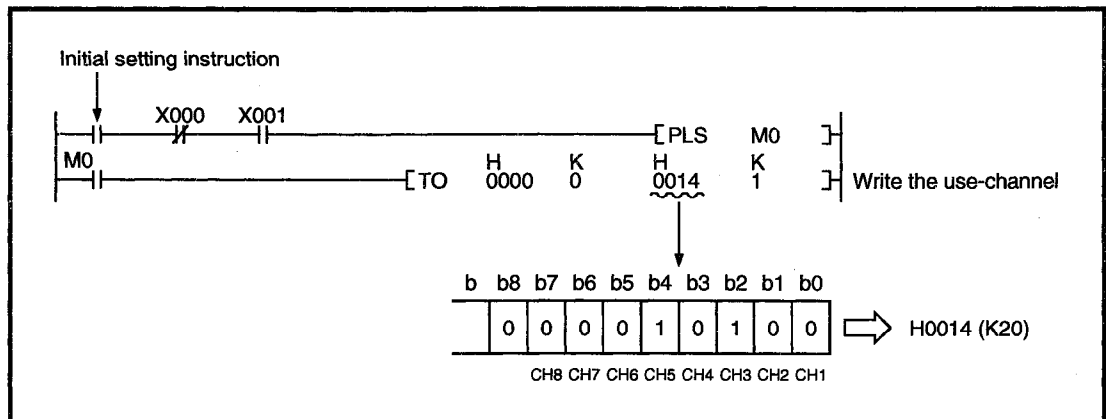



**5.2.5 Read and reset of write data error code**

- (1) Any error code is set at address 34 of the buffer memory in binary. For details, refer to Section 7.1.
- (2) Only the first error code to occur, is stored. For details, refer to Section 3.4.2.
- (3) Reset the error code from the programmable controller CPU.
- (4) Program example
  - a) To read the error code to D3 and output it to Y100 to 107 in BCD.

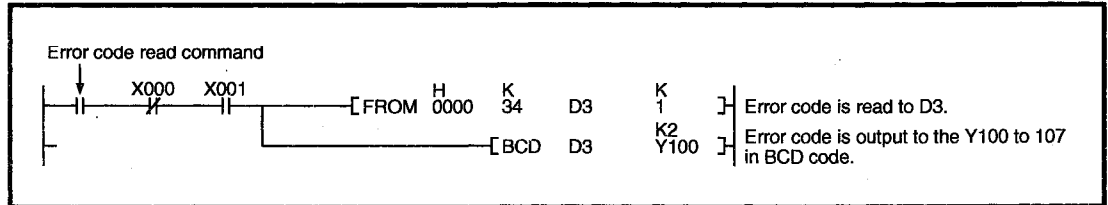

- b) To reset the error code

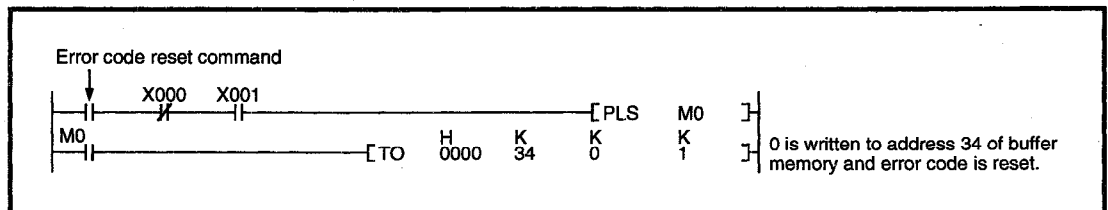

### 5.2.6 Read of A/D conversion end flag

- (1) With the specification of the use-channel set at "A/D conversion," the A/D conversion end state can be confirmed by reading the A/D conversion end flag (at address 35 in the buffer memory).
- (2) To use the A/D conversion end flag as an interlock for reading digital values, use following procedure.

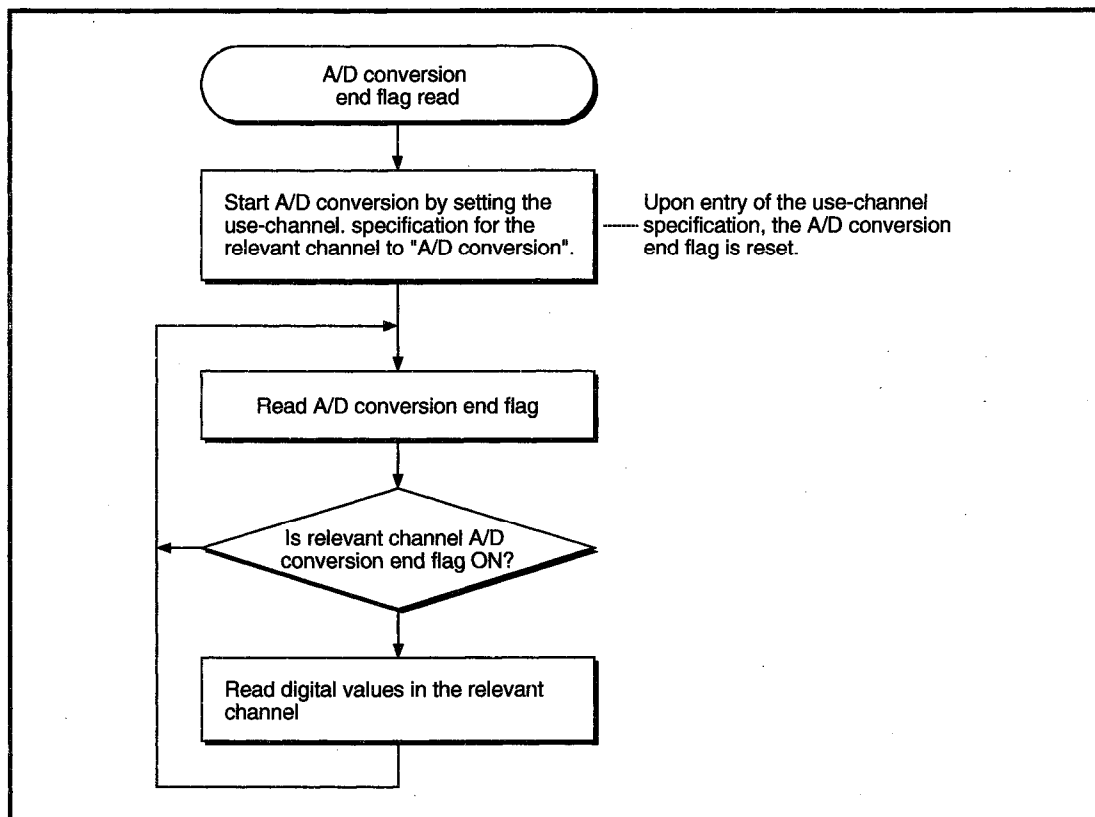



(3) Program example

To read digital value of channel 1 to D10 upon completion of A/D conversion by specifying "500ms averaging processing" for it.

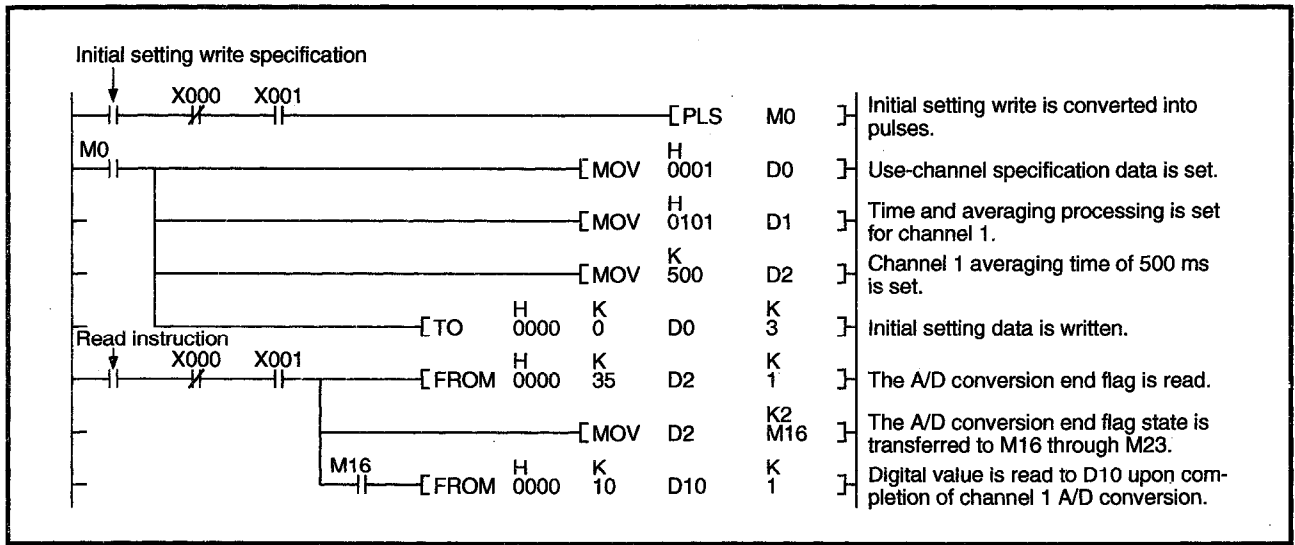

**5.2.7 Application circuit examples**

- (1) Checking the magnitude of the analog signal  
 Program which turns on Y100 when the digital output value of channel 1 is 700 or more, turns on Y101 when it is between 600 and 700, and turns on Y102 when the value is negative.

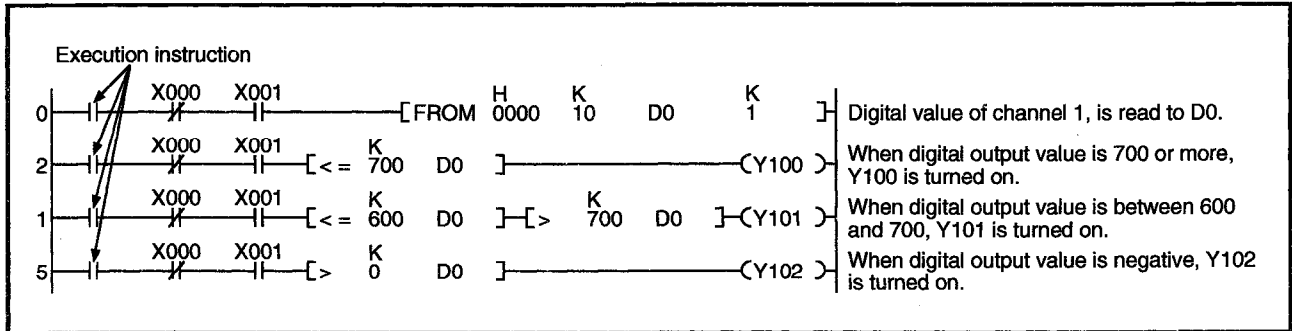

- (2) Digital display of analog signal  
 Program which outputs the digital output value of channel 1 to Y110 to 11F in BCD and turns on Y120 when that value is negative.

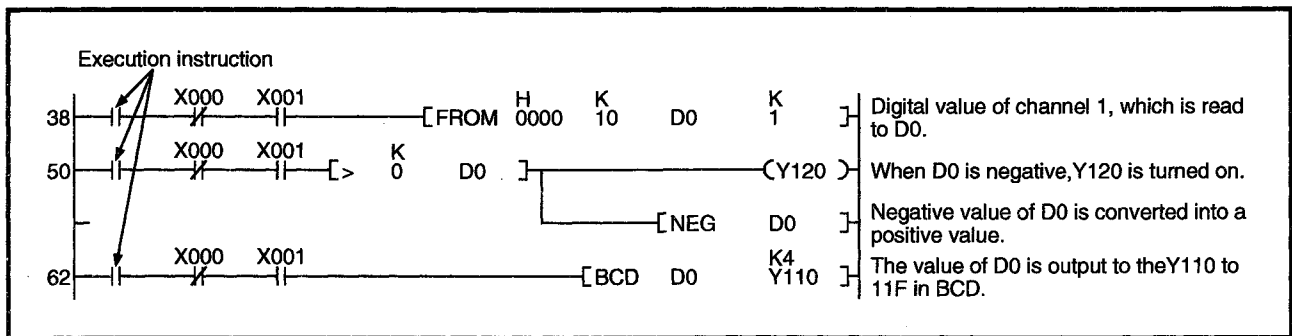

- (3) Circuit which changes a gain to 4, 2, 1/2, and 1/4 times by program  
 The digital output values are changed to the following gains; (all digital value must be > 0)  
 Channel 1: 4 times  
 Channel 2: 2 times  
 Channel 3: 1/2 times  
 Channel 4: 1/4 times

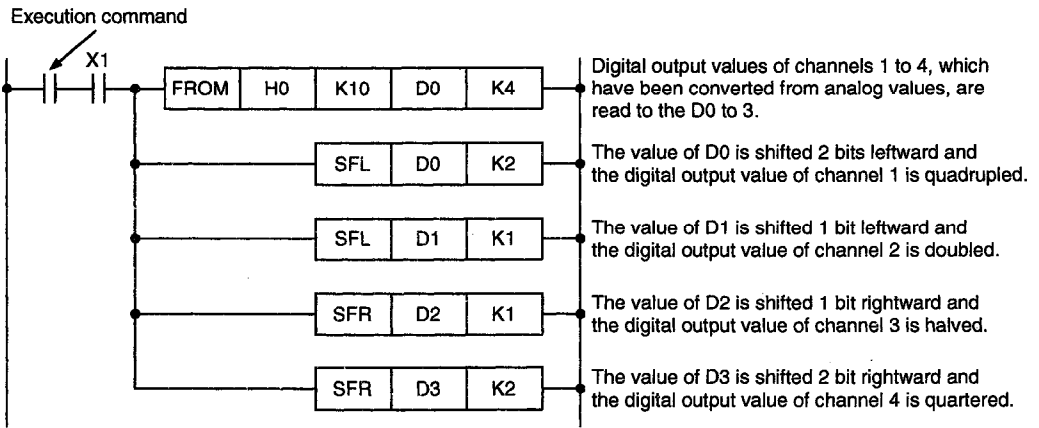

# 6. TEST OPERATION AND CALIBRATION

This section describes offset/gain setting and parameters to be checked by the time operation is started.

See also the A CPU User's Manual.

## 6.1 Offset/Gain Setting

Change the output characteristics as follows. The module is factory-set to an offset value of 0V and a gain value of 5V.

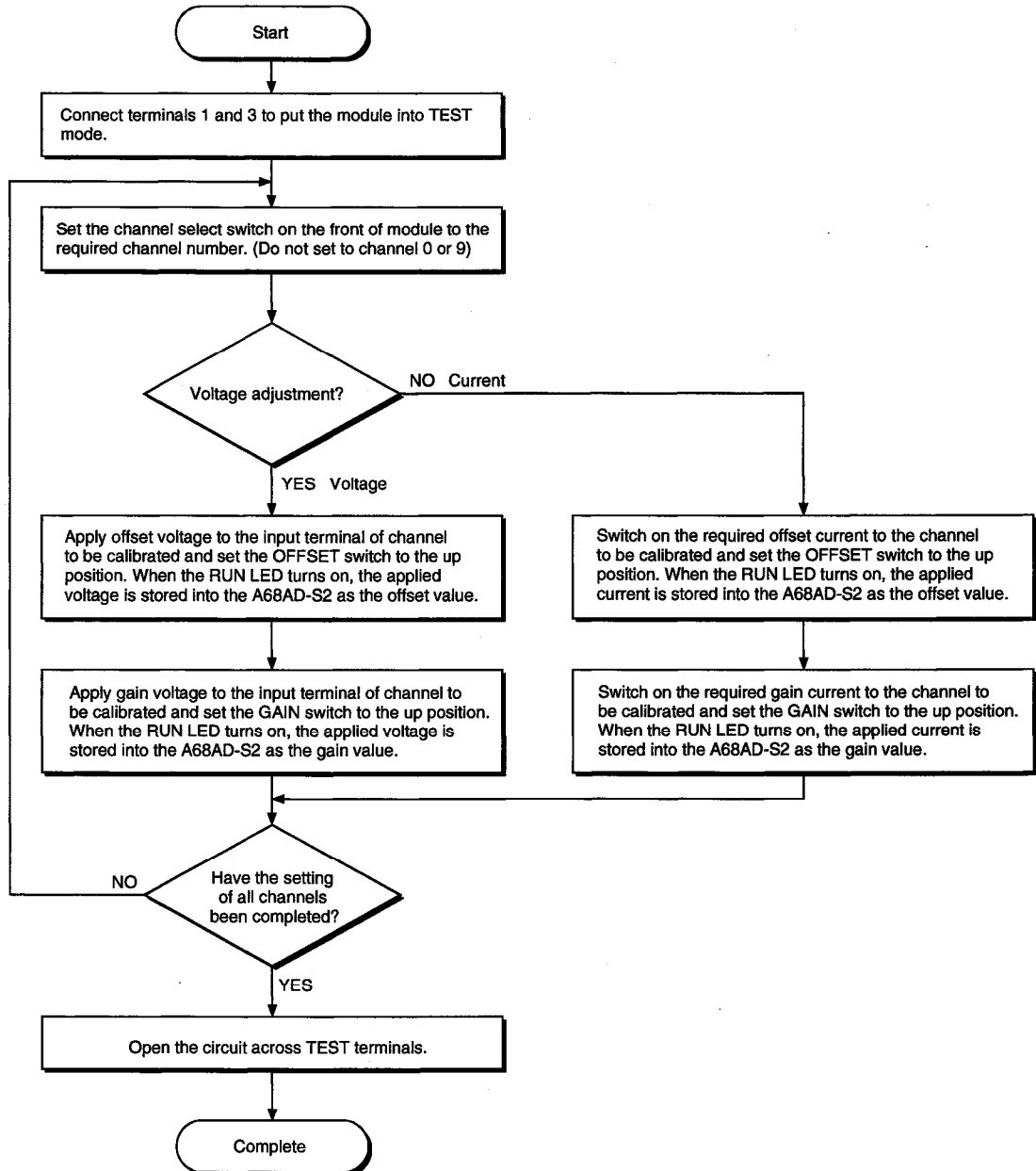

Point
<ol style="list-style-type: none"> <li>1. The offset value and gain value are stored in the A68AD-S2 and are not erased if the power is turned off.</li> <li>2. Perform the offset/gain setting with the CPU in stop mode. When the module is set to test mode, A/D conversion is stopped on all channels. Therefore, use the A/D conversion ready signal as an interlock.</li> <li>3. Perform the offset/gain setting within the range <math>-10</math> to <math>0</math> to <math>+10V</math> DC or <math>-20</math> to <math>0</math> to <math>+20mA</math> DC. If set outside this range, the maximum resolution and overall accuracy may not be within the ranges specified.</li> </ol>

## 6.2 Checks before Starting

Number	Checking Point	Description	Check
1	Loading of module	Is the I/O assignment correct?	<input type="checkbox"/>
2	Offset/gain setting	Has offset/gain been set for all channels used?	<input type="checkbox"/>
		Are set values correct?	<input type="checkbox"/>
		Has the module been returned to normal mode by opening the circuit across TEST terminals?	<input type="checkbox"/>
3	Connection to A68AD-S2	Are terminal block connections correct?	<input type="checkbox"/>
		Are terminal screws of terminal block tightened securely?	<input type="checkbox"/>
		Is the wire size correct?	<input type="checkbox"/>

Table 6.1 Points for Checking

## 7. TROUBLESHOOTING

This chapter describes errors, which may occur during the use of the A68AD-S2, and troubleshooting procedures for such errors.

### 7.1 Write Data Error Code List

The following three errors may occur during the write operation of the number of channels, averaging processing specification, averaging time, and averaging count. The numeric value of the error code enclosed in    indicates the channel number for which the error has occurred.

Description	Error Code
A value other than 20 to 10000ms has been set as an averaging time set value.	<span style="border: 1px dashed black; padding: 2px;">  </span> 0 to 4
A value other than 1 to 4000 times has been set as an averaging count set value.	<span style="border: 1px dashed black; padding: 2px;">  </span> 5 to 8

Table 7.1 Types of Write Data Error Codes

Point
<p>1. <span style="border: 1px dashed black; padding: 2px;">  </span>0 to 4 and <span style="border: 1px dashed black; padding: 2px;">  </span>5 to 8 of write data error code are used only to make differentiation between averaging time and averaging count, respectively. The individual numerals do not have any significance.</p> <p>2. When an error has occurred, check the write data error code, reset the error code, and then write the corrected data. (Refer to Section 3.4.2.)</p> <p>Example:</p> <p>(1) Error code 32 has occurred Since the averaging time of channel 3 is wrong, change the value to within the range 20 to 10000ms.</p> <p>(2) Error code 88 has occurred Since the averaging count of channel 8 is wrong, change the value to within the range 1 to 4000 times.</p>

## 7.2 Troubleshooting

This section describes simple troubleshooting procedures for use of the A68AD-S2. For problems relating to the CPU module, refer to the A CPU User's Manual.

### 7.2.1 Troubleshooting flow chart

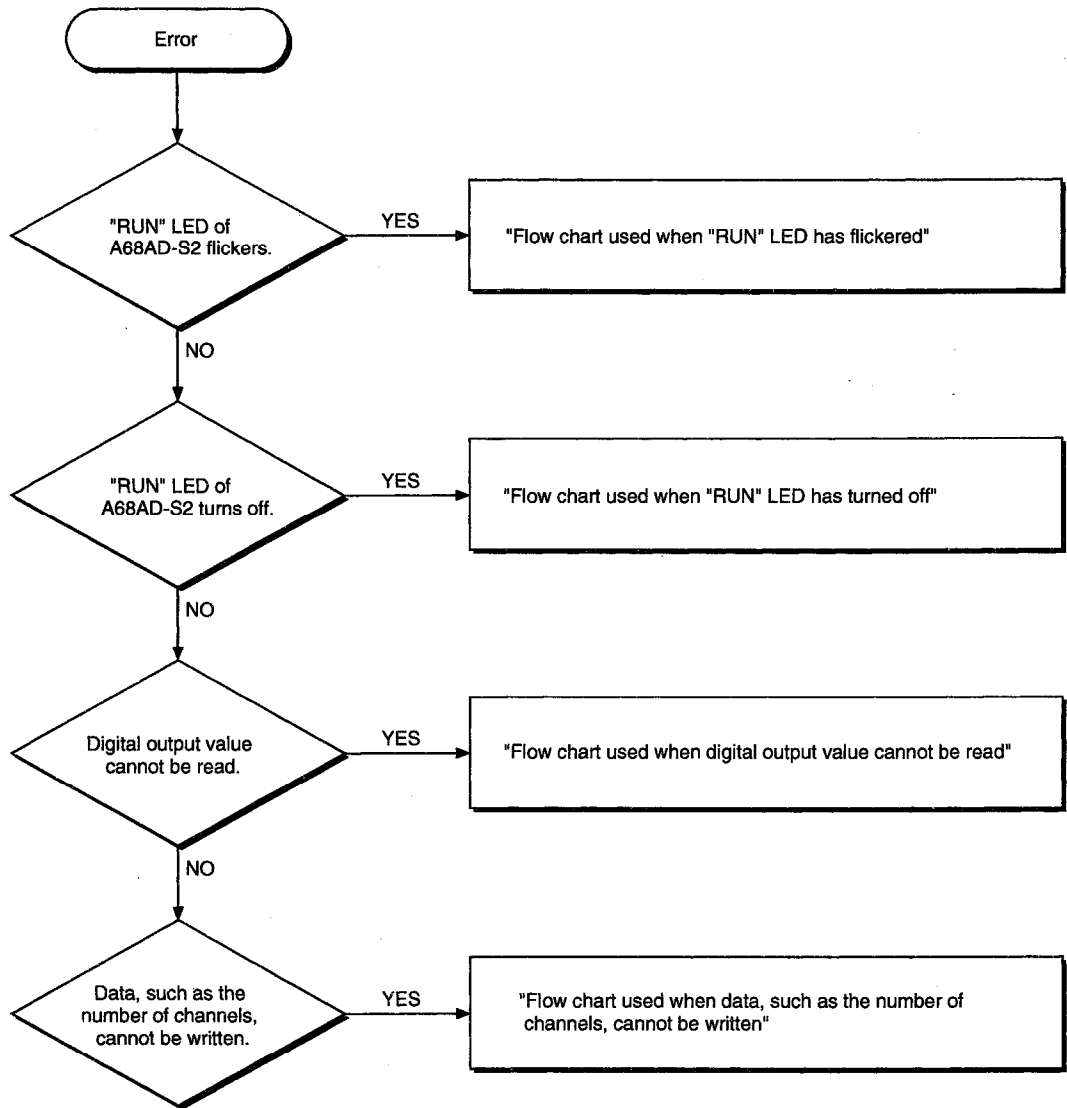

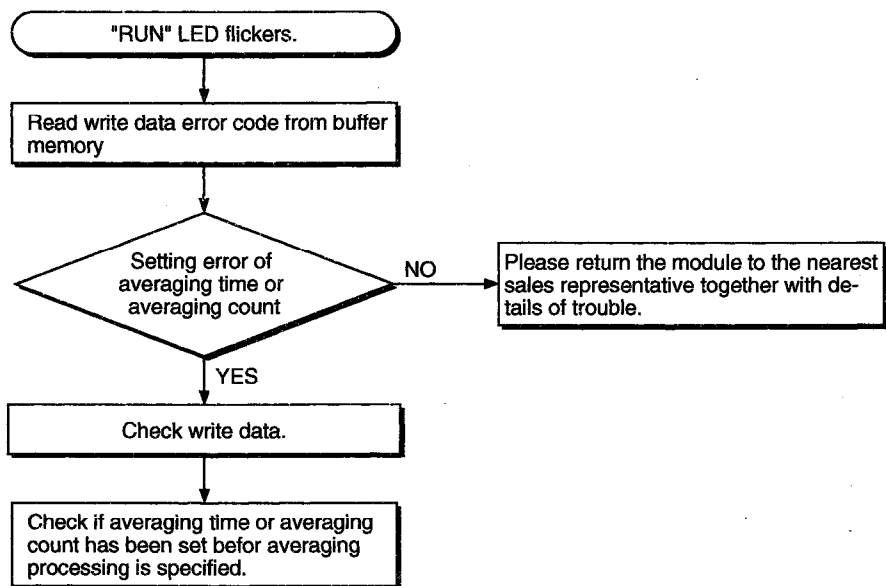
**7.2.2 Flow chart used when "RUN" LED has flickered**



7.2.3 Flow chart used when "RUN" LED has turned off

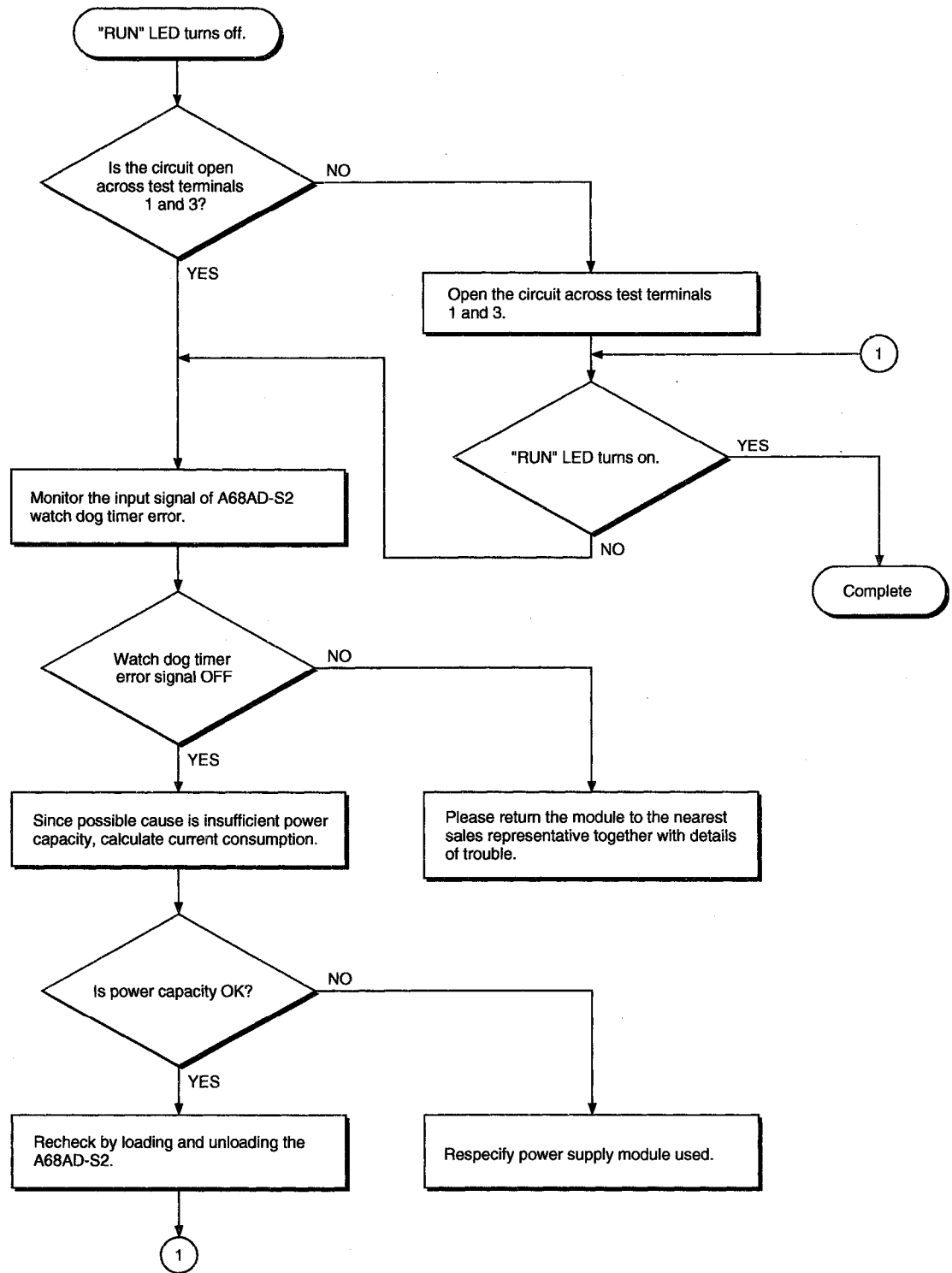

7.2.4 Flow chart used when digital output value cannot be read

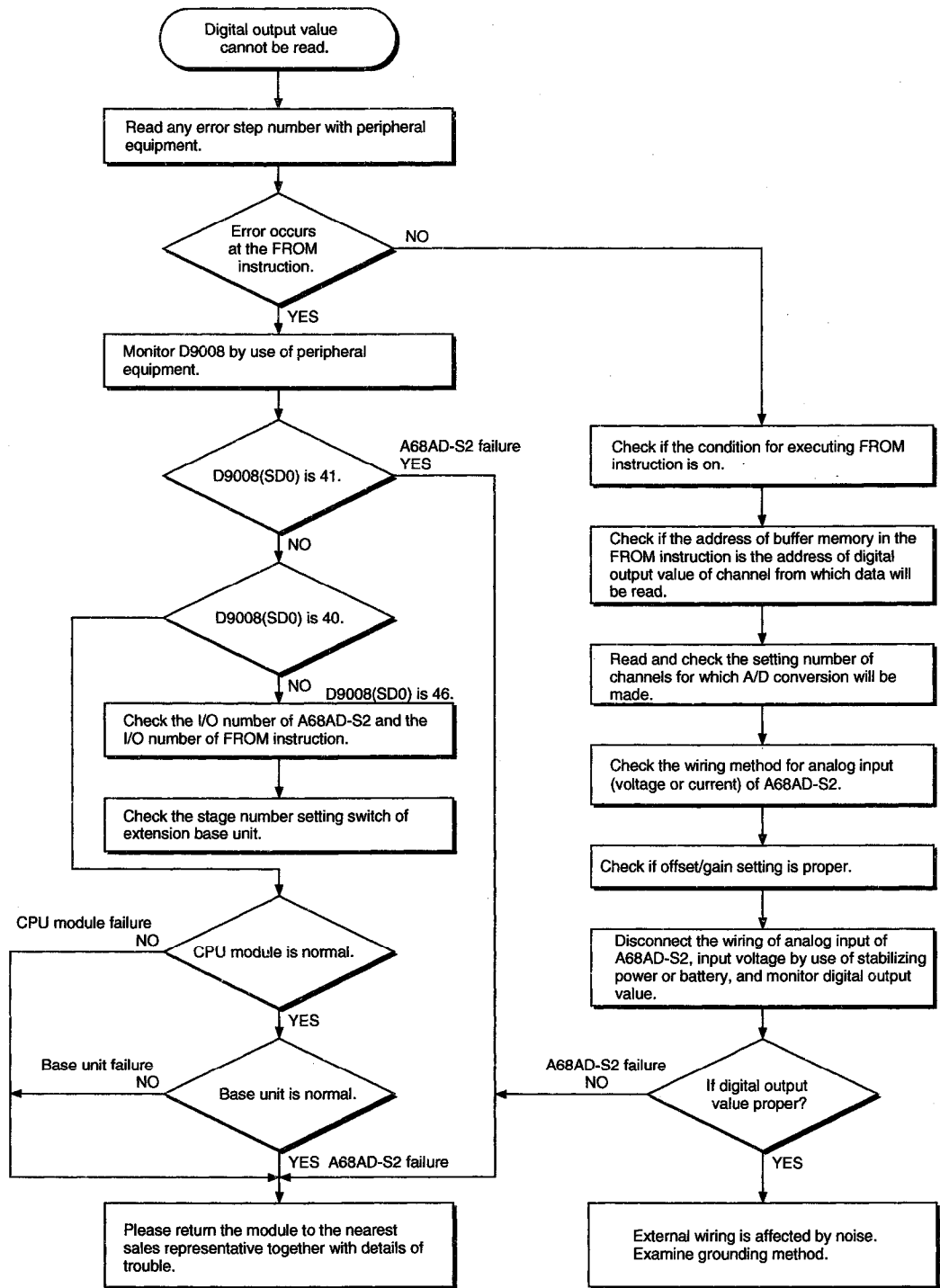

**Remarks**

When an error occurs during execution of FROM/TO instruction from A/QnACPU to the A68AD-S2, the error code is stored in D9008 (or SD0 in the case of QnACPU).

For details regarding the error codes, refer to the User Manual for the CPU used.

7.2.5 Flow chart used when data, such as the use-channels, cannot be written

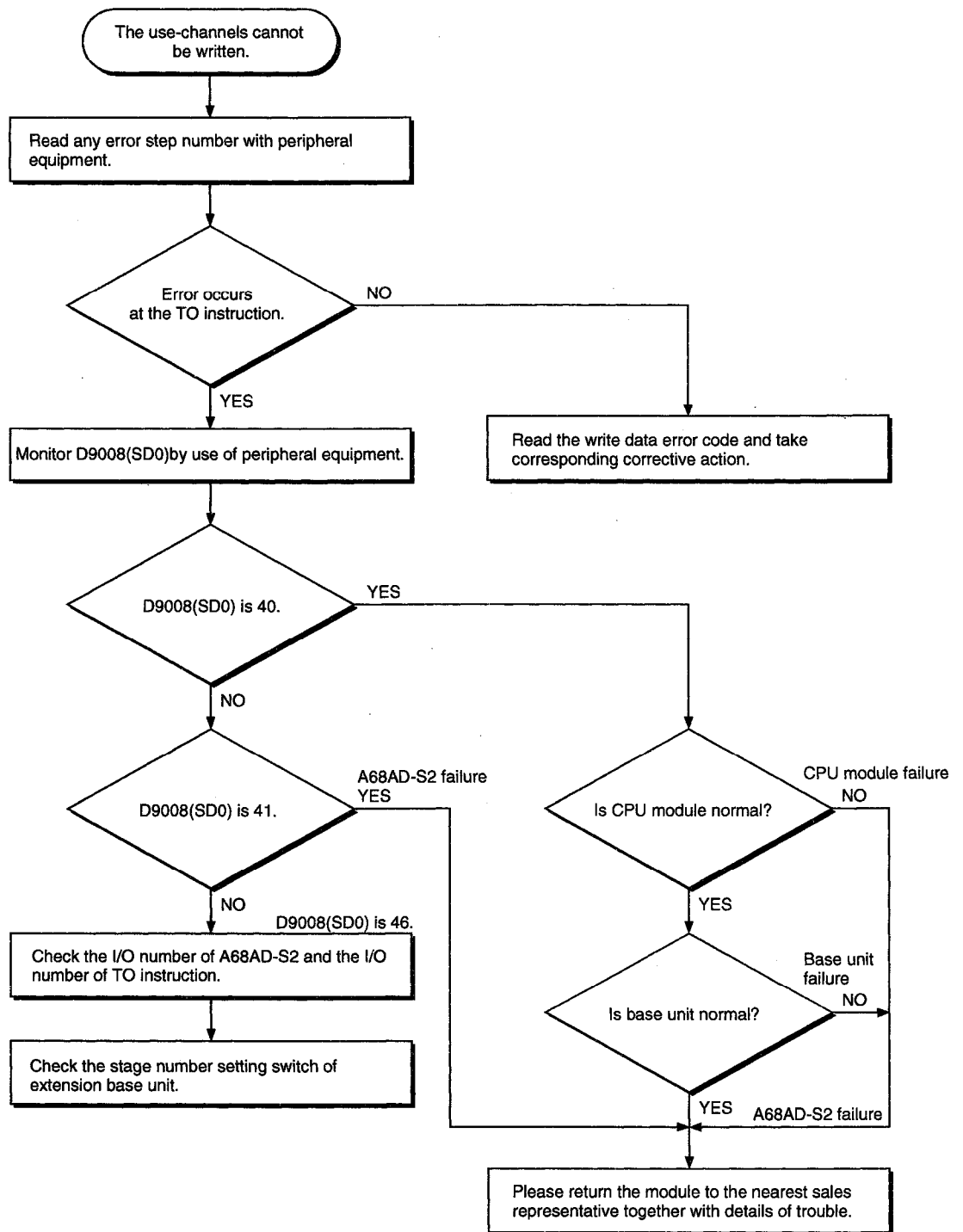

# APPENDIX

## Appendix 1 Precautions to be Taken to Replace the A68AD with the A68AD-S2

When the A68AD is to be replaced by the A68AD-S2 in the existing system operating with the A68AD, change the A/D conversion channel specification program.

In the case of the A68AD-S2, it is necessary to change the program since the A/D conversion channels are specified channel by channel. For details of the program, refer to Sections 5.2.1. Writing connections, digital value read, and averaging processing specification do not need to be changed since they are the same as with the A68AD.

For differences between the A68AD-S2 and the A68AD, refer to Section 1.1.

An example of changing the A/D conversion channel specification is given below.

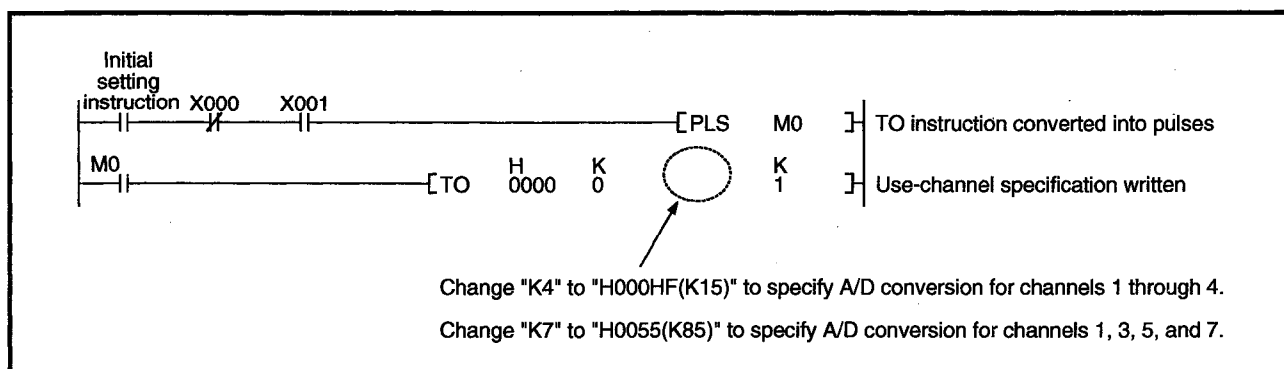

Appendix 2 External Dimensions

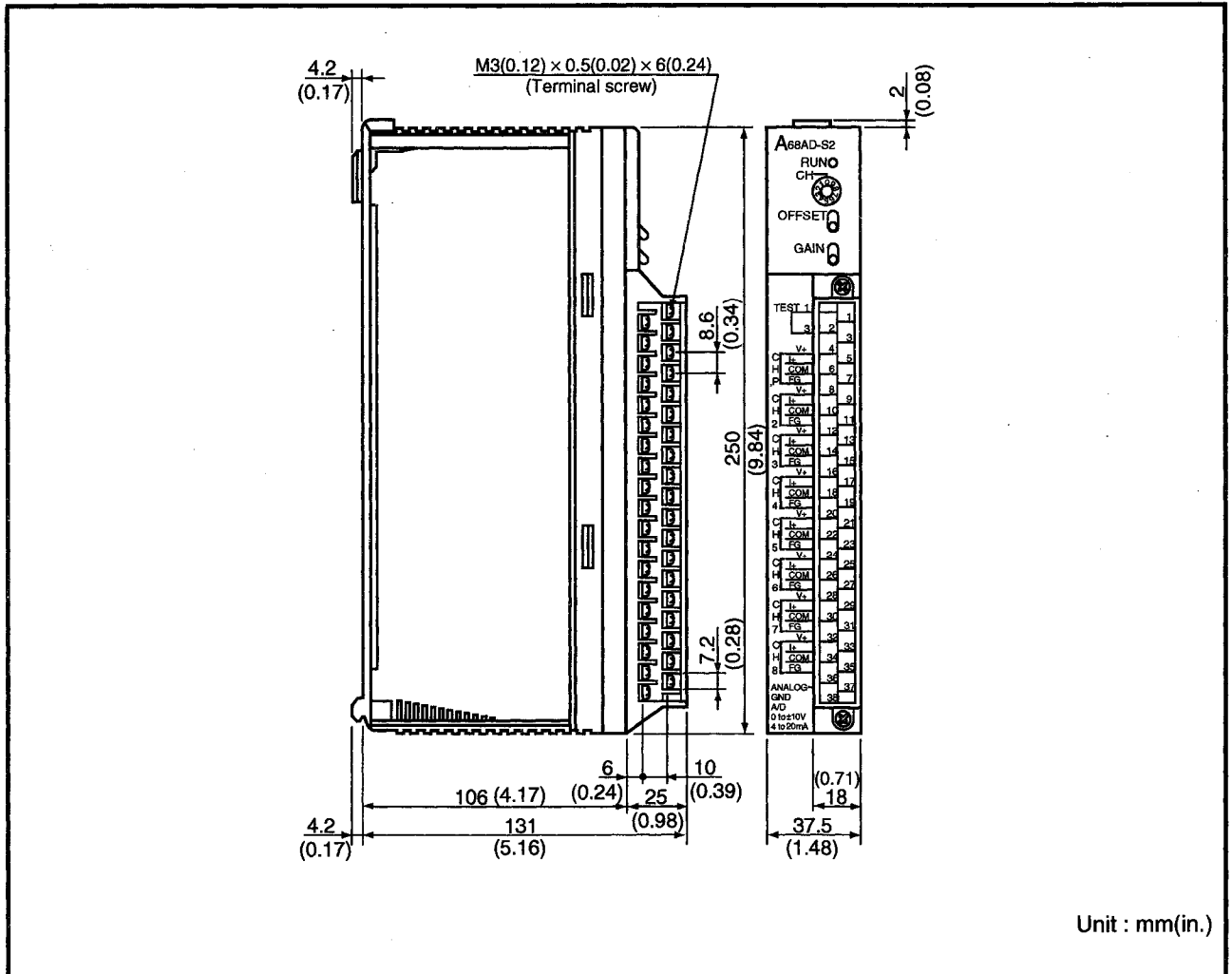

# Analog-Digital Converter Module type A68AD-S2

## User's Manual

MODEL	A68AD-S2-U-SHO-E
MODEL CODE	13JL76
SH(NA)-4009-A(9811)MEE	



HEAD OFFICE : MITSUBISHI DENKI BLDG MARUNOUCHI TOKYO 100-8310 TELEX : J24532 CABLE MELCO TOKYO  
NAGOYA WORKS : 1-14 , YADA-MINAMI 5 , HIGASHI-KU, NAGOYA , JAPAN

When exported from Japan, this manual does not require application to the Ministry of International Trade and Industry for service transaction permission.

Specifications subject to change without notice.