

Precaution for Compliance with UL Standards and CSA Standards

Notice to Users of NS series PTs (hereafter, "PTs") in the USA and Canada

When installing a PT in the USA or Canada, please follow the installation information provided in this document instead of the general information in the instruction manuals in order to use the product under the conditions for which it was certified by UL and CSA. These conditions are according to the National Electrical Code in the USA and the Canadian Electrical Code and may vary from information given in the product manuals or safety precautions

©OMRON Corporation 2008-2013

All Rights Reserved

1156327-3E

■ Installation in a Control Panel

The PT is normally installed on a flat surface in an operation panel. Use an enclosure of the type given in the following table for the operation panel. Install the PT using the following procedure.

1,2,3...

1. Create an opening in the panel.

Panel board thickness: 1.6 to 4.8 mm

Model	Dimensions	Enclosure type
		* Following enclosure types are recognized by UL. Outdoor use is not permitted by OMRON.
NS12	Width $302^{+1}/_{-0}$ x Height $228^{+1}/_{-0}$ mm	Type 1, 12, 13, 4X indoor use only
NS10	Width $302^{+1}/_{-0}$ x Height $228^{+1}/_{-0}$ mm	Type 1, 12, 13, 4X indoor use only
NS8	Width $220.5^{+0.5}/_{-0}$ x Height $165.5^{+0.5}/_{-0}$ mm	Type 1, 12, 13
NS5	Width $184^{+0.5}/_{-0}$ x Height $131^{+0.5}/_{-0}$ mm	Type 1, 4X indoor use only

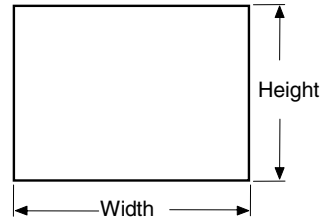

2. Install the PT from the front of the panel.

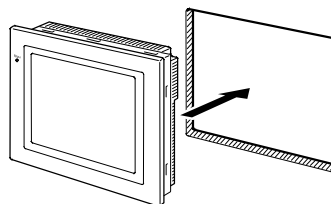

3. Secure the PT to the panel using the provided Mounting Brackets. Tighten the Brackets evenly to the specified torque. Excessive tightening or insufficient tightening may deform the front sheet. To maintain water-resistant performance, the tightening torque must be 4.4 to 5.3 lb-in (0.5 to 0.6 N·m).

NS5 Mounting Diagram

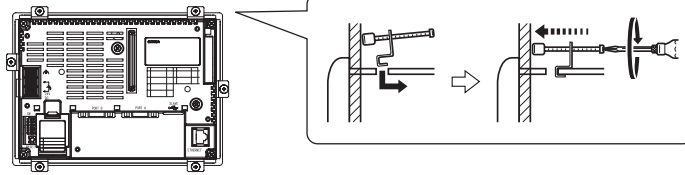

NS8 Mounting Diagram

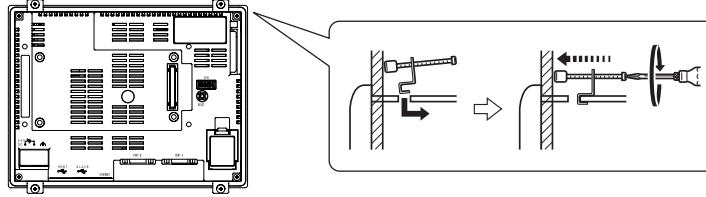

NS10 and NS12 Mounting Diagram

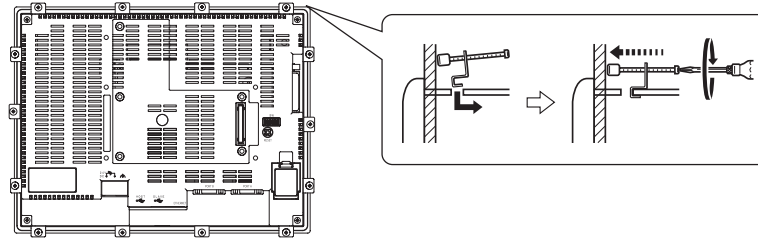

■ 24-VDC Power Supply Wiring for Models with DC Power Supply Input

1. Use an isolated DC power supply.
2. Do not use crimp terminals to wire the power.
3. Use the following tightening torque and wire range for the terminal screws.
7 lb in (0.8 N·m), AWG20 to AWG14

■ Accessory Units for PTs

NS-CA001: Video Input Unit (4 input channels)

NS-CA002: Video Input Unit (2 input channels, 1 RGB channel)

NS-CLK21: Controller Link Interface Unit

■ Mounting the NS-CA001, NS-CA002, or NS-CLK21

1,2,3...

1. As shown in the following diagram, connect the NS-CA001, NS-CA002, or NS-CLK21 to the expansion interface connector on the PT.
2. After connecting, secure the NS-CA001/CA002/CLK21 with the four screws. The tightening torque is 5.3 lb-in (0.6 N·m).
3. Insert screws in the screw holes for attaching the cover and tighten them slightly. Align the cover's screw holes with the screws and mount the cover. The tightening torque is 5.3 lb-in (0.6 N·m).

*The NS-CA001/CA002 cannot be mounted to an NS5 PT.

*The NS-CLK21 cannot be mounted to an NS8 or NS5 PT.

NS-CA002 Mounting Diagram

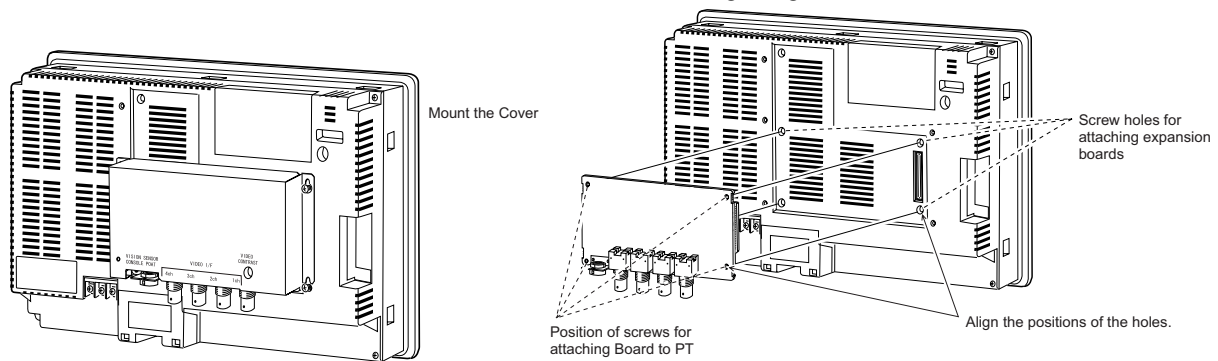

■ RS-232C Cable for PT

Use one of the recommended cables: XW2Z Series (e.g., XW2Z-200S-CV)

■ USB Host Printer Cable

Use one of the recommended cables: NS-US52 or NS-US22

■ Console Cable for Video Input Unit

Use one of the recommended cables: F150-VKP Series (e.g., F150-VKP(2m))

These cables are for Internal Wiring Only.

Separate cables from live parts and all other wiring by a minimum of 6.4 mm (1/4 in).

■ **Operating Temperature**

The PT must be used within the following operating temperature ranges.

	NS12	NS10	NS8	NS5
Surrounding air temperature according to angle of display off horizontal Without any Expansion Unit installed	0° to 30°: 0 to 45°C 30° to 90°: 0 to 50°C	0° to 30°: 0 to 45°C 30° to 90°: 0 to 50°C	0° to 30°: 0 to 45°C 30° to 90°: 0 to 50°C	0° to 90°: 0 to 50°C
Surrounding air temperature according to angle of display off horizontal With an Expansion Unit installed. (NS-CA001)	0° to 30°: 0 to 35°C 30° to 90°: 0 to 50°C	0° to 30°: 0 to 35°C 30° to 90°: 0 to 50°C	0° to 30°: 0 to 35°C 30° to 90°: 0 to 45°C 90°: 0 to 50°C	
Surrounding air temperature/Ambient temperature according to angle of display off horizontal With an Expansion Unit installed. (NS-CA002)	0° to 30°: 0 to 35°C 30° to 90°: 0 to 45°C 90°: 0 to 50°C	0° to 30°: 0 to 35°C 30° to 90°: 0 to 45°C 90°: 0 to 50°C	0° to 30°: 0 to 35°C 30° to 90°: 0 to 45°C 90°: 0 to 50°C	
Surrounding air temperature according to angle of display off horizontal With an Expansion Unit installed. (NS-CLK21)	0° to 30°: 0 to 35°C 30° to 90°: 0 to 50°C	0° to 30°: 0 to 35°C 30° to 90°: 0 to 50°C		

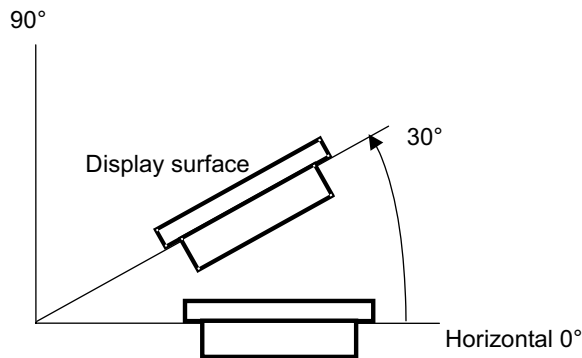

■ **Compliance with ANSI.2.12.01 Class I Division 2**

This device is open-type and is required to be installed in a suitable enclosure that can only be accessed with the use of a tool or key.

This equipment is suitable for use in Class I, Div. 2, Groups A, B, C, D or Non-Hazardous Locations Only.

Cet équipement convient à l'utilisation dans des emplacements de Classe I, Division 2, Groupes A, B, C, D, ou ne convient qu'à l'utilisation dans des endroits non dangereux.

WARNING - Explosion Hazard - Substitution of Components May Impair Suitability For Class I, Div. 2.

AVERTISSEMENT - Risque d'explosion - La substitution de composants peut rendre ce matériel inacceptable pour les emplacements de Classe I, Division 2

WARNING - Explosion Hazard - Do Not Disconnect Equipment Unless Power Has Been Switched Off Or The Area Is Known To Be Non-Hazardous.

AVERTISSEMENT - Risque d'explosion - Avant de débrancher l'équipement, couper le courant ou s'assurer que l'emplacement est désigné non dangereux