

OMRON

Digital Multicircuit Protector

S8M

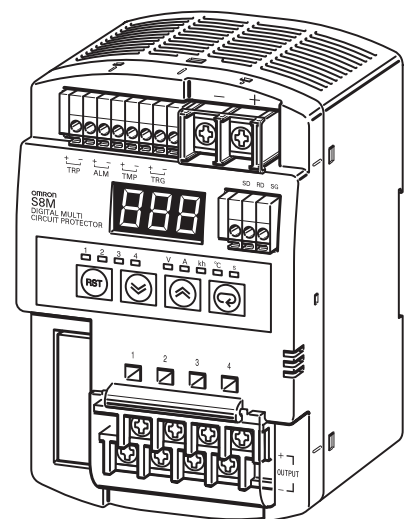

USER'S MANUAL

Cat. No. Z241-E1-01

S8M Digital Multicircuit Protector

User's Manual

Produced June 2006

TABLE OF CONTENTS

SECTION 1

Features and Functions 1

1-1	Overview of Features and Functions	2
1-2	S8M Operations and Operating Modes	7
1-3	Table of Basic Functions	10
1-4	S8M Operating Procedure	11

SECTION 2

Specifications and Functions 13

2-1	Component Names and Functions	14
2-2	Internal Configuration	16
2-3	Specifications	18
2-4	Basic Function Details	22
2-5	Startup Sequence Function	30
2-6	Shutdown Sequence Function	31

SECTION 3

Installation and Wiring 33

3-1	Installation Environment	34
3-2	Installation	35
3-3	Wiring	39
3-4	RS-232C Port Wiring (S8M-CP04-R and S8M-CP04-RS Only)	43

SECTION 4

Parameter Settings 47

4-1	Parameter Table	48
4-2	Parameter Setting Ranges	49
4-3	Switching the Operating Mode	49
4-4	Changing the Protection Level	54
4-5	Switching to Setting Mode	55
4-6	Individual Branch Output Settings	56
4-7	Shared Parameter Settings	60
4-8	Special Settings and Communications Settings	64

SECTION 5

Trial Operation to Actual Operation 73

5-1	Test Mode	74
5-2	Connection/Disconnection Test	76
5-3	Checking Sequence Operation	77
5-4	Run Mode	78

TABLE OF CONTENTS

SECTION 6

Support Tool	81
6-1 Installing the Support Tool	82
6-2 Starting the Support Tool	85
6-3 Setting and Saving Parameters	87
6-4 Monitoring	92
6-5 Other Settings	96

SECTION 7

Communications	99
7-1 CompoWay/F Communications Specifications	100
7-2 Frame Structure	101
7-3 Details of Services	109
7-4 Read Controller Information	112
7-5 Read Controller Attributes	114
7-6 Read Controller Status	115
7-7 Echoback Test	116
7-8 Operation Command	117
7-9 Response Code List	118
7-10 ASCII List	119

SECTION 8

Error Processing	121
8-1 Troubleshooting	122
8-2 Seven-segment Error Codes	123
8-3 Clearing Errors	125

Appendices

A Glossary	129
B List of Operations	133

Revision History	137
-------------------------------	------------

About this Manual:

This manual describes the installation and operation of the S8M Digital Multicircuit Protector and includes the sections described below.

Please read this manual carefully and be sure you understand the information provided before attempting to install or operate the S8M Digital Multicircuit Protector. Be sure to read the precautions provided in the following section.

Precautions provides general precautions for using the S8M Digital Multicircuit Protector and related devices.

Section 1 introduces the features and functions of the S8M Digital Multicircuit Protector and concepts related to its operation.

Section 2 identifies the S8M Digital Multicircuit Protector's components, provides specifications, and describes the basic functions.

Section 3 describes how to install and wire the S8M Digital Multicircuit Protector.

Section 4 describes how to set the S8M's various parameters.

Section 5 describes how to connect the branch outputs and test operation.

Section 6 describes how to install and operate the S8M Support Tool.

Section 7 describes how to use S8M communications.

Section 8 provides information on troubleshooting problems that may occur with the S8M Digital Multicircuit Protector.

The appendices provide a glossary of terms related to the S8M and flowcharts of S8M key operations.



WARNING Failure to read and understand the information provided in this manual may result in personal injury or death, damage to the Product, or Product failure. Please read each section in its entirety and be sure you understand the information provided in the section and related sections before attempting any of the procedures or operations given.

Read and Understand this Manual

Please read and understand this manual before using the product. Please consult your OMRON representative if you have any questions or comments.

Warranty and Limitations of Liability

WARRANTY

OMRON's exclusive warranty is that the products are free from defects in materials and workmanship for a period of one year (or other period if specified) from date of sale by OMRON.

OMRON MAKES NO WARRANTY OR REPRESENTATION, EXPRESS OR IMPLIED, REGARDING NON-INFRINGEMENT, MERCHANTABILITY, OR FITNESS FOR PARTICULAR PURPOSE OF THE PRODUCTS. ANY BUYER OR USER ACKNOWLEDGES THAT THE BUYER OR USER ALONE HAS DETERMINED THAT THE PRODUCTS WILL SUITABLY MEET THE REQUIREMENTS OF THEIR INTENDED USE. OMRON DISCLAIMS ALL OTHER WARRANTIES, EXPRESS OR IMPLIED.

LIMITATIONS OF LIABILITY

OMRON SHALL NOT BE RESPONSIBLE FOR SPECIAL, INDIRECT, OR CONSEQUENTIAL DAMAGES, LOSS OF PROFITS OR COMMERCIAL LOSS IN ANY WAY CONNECTED WITH THE PRODUCTS, WHETHER SUCH CLAIM IS BASED ON CONTRACT, WARRANTY, NEGLIGENCE, OR STRICT LIABILITY.

In no event shall the responsibility of OMRON for any act exceed the individual price of the product on which liability is asserted.

IN NO EVENT SHALL OMRON BE RESPONSIBLE FOR WARRANTY, REPAIR, OR OTHER CLAIMS REGARDING THE PRODUCTS UNLESS OMRON'S ANALYSIS CONFIRMS THAT THE PRODUCTS WERE PROPERLY HANDLED, STORED, INSTALLED, AND MAINTAINED AND NOT SUBJECT TO CONTAMINATION, ABUSE, MISUSE, OR INAPPROPRIATE MODIFICATION OR REPAIR.

Application Considerations

SUITABILITY FOR USE

OMRON shall not be responsible for conformity with any standards, codes, or regulations that apply to the combination of products in the customer's application or use of the products.

At the customer's request, OMRON will provide applicable third party certification documents identifying ratings and limitations of use that apply to the products. This information by itself is not sufficient for a complete determination of the suitability of the products in combination with the end product, machine, system, or other application or use.

The following are some examples of applications for which particular attention must be given. This is not intended to be an exhaustive list of all possible uses of the products, nor is it intended to imply that the uses listed may be suitable for the products:

- Outdoor use, uses involving potential chemical contamination or electrical interference, or conditions or uses not described in this manual.
- Nuclear energy control systems, combustion systems, railroad systems, aviation systems, medical equipment, amusement machines, vehicles, safety equipment, and installations subject to separate industry or government regulations.
- Systems, machines, and equipment that could present a risk to life or property.

Please know and observe all prohibitions of use applicable to the products.

NEVER USE THE PRODUCTS FOR AN APPLICATION INVOLVING SERIOUS RISK TO LIFE OR PROPERTY WITHOUT ENSURING THAT THE SYSTEM AS A WHOLE HAS BEEN DESIGNED TO ADDRESS THE RISKS, AND THAT THE OMRON PRODUCTS ARE PROPERLY RATED AND INSTALLED FOR THE INTENDED USE WITHIN THE OVERALL EQUIPMENT OR SYSTEM.

PROGRAMMABLE PRODUCTS

OMRON shall not be responsible for the user's programming of a programmable product, or any consequence thereof.

Disclaimers

CHANGE IN SPECIFICATIONS

Product specifications and accessories may be changed at any time based on improvements and other reasons.

It is our practice to change model numbers when published ratings or features are changed, or when significant construction changes are made. However, some specifications of the products may be changed without any notice. When in doubt, special model numbers may be assigned to fix or establish key specifications for your application on your request. Please consult with your OMRON representative at any time to confirm actual specifications of purchased products.

DIMENSIONS AND WEIGHTS

Dimensions and weights are nominal and are not to be used for manufacturing purposes, even when tolerances are shown.

PERFORMANCE DATA

Performance data given in this manual is provided as a guide for the user in determining suitability and does not constitute a warranty. It may represent the result of OMRON's test conditions, and the users must correlate it to actual application requirements. Actual performance is subject to the OMRON Warranty and Limitations of Liability.

ERRORS AND OMISSIONS

The information in this document has been carefully checked and is believed to be accurate; however, no responsibility is assumed for clerical, typographical, or proofreading errors, or omissions.

Safety Precautions

■ Precaution Classifications

The following conventions are used to indicate and classify precautions in this manual.

Always heed the information provided with them. Failure to heed precautions can result in injury to people or damage to property.

CAUTION	Indicates a potentially hazardous situation which, if not avoided, may result in minor or moderate injury or in property damage.
----------------	--

■ Cautions

CAUTION	
Minor electric shock, fire, or Product failure may occasionally occur. Do not disassemble, modify, or repair the Product or touch interior of the Product.	
Minor burns may occasionally occur. Do not touch the Product during power is being supplied or immediately after power is turned OFF.	
Fire may occasionally occur. Tighten terminal screws to the specified torque. Power input terminals: M4 1.08 N·m (9.6 in. lb.) Branch output terminals: M3.5 0.8 to 1.0 N·m (7.2 to 8.8 in. lb.)	
Minor electric shock, fire, or Product failure may occasionally occur. Do not allow any pieces of metal or conductors or any clippings or cuttings resulting from installation work to enter the Product.	
The Product will be damaged. Do not incorrectly connect the polarity of power input terminals.	

Precautions for Safe Use

■ Operating the S8M

Unlike ordinary mechanical circuit protectors, the S8M does not have contacts for switching. The S8M uses semiconductor relays to switch the circuits ON/OFF and cut off the outputs. Read and understand the following features before operating the S8M.

■ Installation and Storage Environment

1. Store the Product at an ambient temperature of -25 to 65°C and relative humidity of 25% to 90%.
2. Poor heat dissipation resulting from improper installation conditions may occasionally deteriorate or damage internal parts. Do not use any mounting method other than a standard one.
3. Internal parts may occasionally be deteriorated or broken. Do not use the Product in conditions exceeding the derating (in portion (1) of the derating curve).
4. The surrounding air temperature for UL 508 listing and UL 60950-1 recognition is 50°C .
5. Use the Product where the relative humidity is 25% to 85%.
6. Do not use the Product where it would be subjected to direct sunlight.
7. Do not use the Product where it would be subjected to the possibility of penetration of liquid, foreign substance, or corrosive gas.
8. Do not use the Product where it would be subjected to shock or vibration. A device such as a contact breaker may be a vibration source. Install the Product as far as possible from external devices. Additionally, install a PFP-M End Plate on each side of the Product.
9. If the Product is used in an area with excessive electronic noise, be sure to separate the Product as far as possible from the noise sources.
10. Tripping performance depends on the ambient operating temperature. Use the Product within the derating curve (page xiii).

■ Wiring

- Minor electric shock during operation may occasionally occur. Always attach the terminal cover when using the S8M.
- Minor fire may possibly occur. Ensure that input and output terminals are wired correctly.
- Increases in the temperature of internal parts resulting from heating of wiring materials may result in deterioration or damage to internal parts. Use wiring materials suitable to the current being used. The following wiring materials, torque, and strip length are recommended to prevent heating and possible fires in wiring materials.

Recommended Wire Types

Terminals	Wiring materials	Torque	Strip length
Power input terminals	AWG14 (2.081 mm^2) $\times 2$	Solid, Stranded	1.08 N·m (9.6 in. lb.)
Branch output terminals	AWG16 to 20 (1.309 to 0.517 mm^2)		0.8 to 1.0 N·m (7.2 to 8.8 in. lb.)
Other terminals	AWG18 to 26 (0.823 to 0.129 mm^2)	---	10 mm

- It is conceivable that internal parts may be deteriorated or damaged. Do not repeatedly perform tripping or recovery operations more than necessary.
- Do not apply more than 100 N force to the terminal block when tightening screws.
- Be sure to remove the sheet covering the Product for machining before power-ON so that it does not interfere with heat dissipation.
- The S8M takes a DC power input. Do not connect AC power to the power input terminals.

■ Derating Curve

The temperature range within which the S8M can be used is restricted by the maximum current that normally flows for any one branch output. This restriction is given as a derating curve.

Use the S8M within the derating curve. If necessary, use forced cooling.

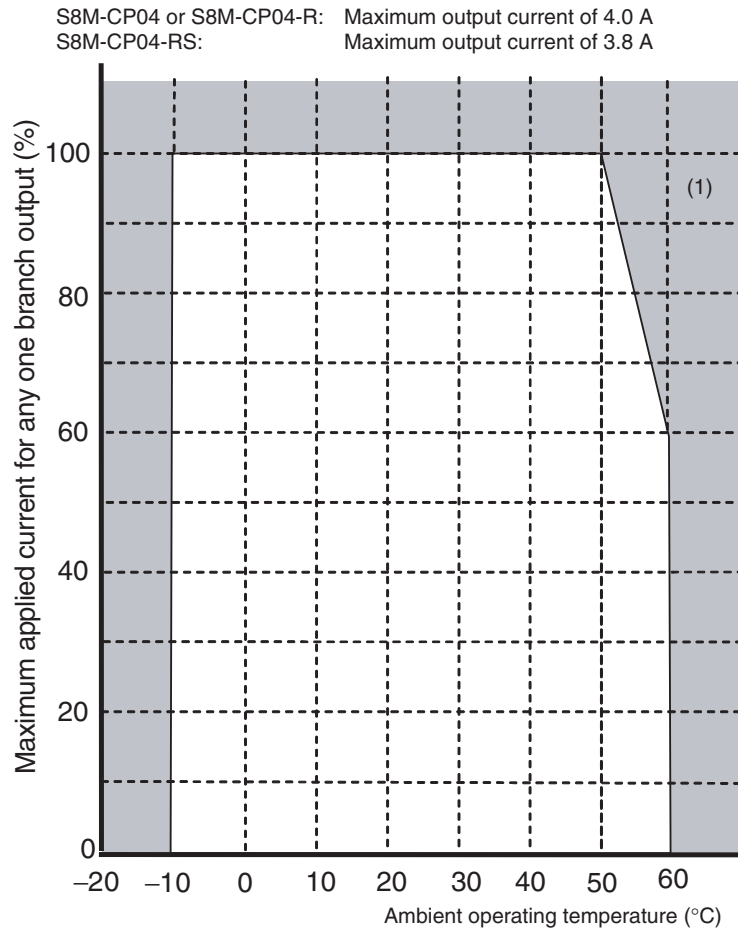

Precautions for Correct Use

■ Installation

• Mounting Direction

Always install the S8M on a DIN Rail. For details, refer to *3-2 Installation*.

Standard horizontal mounting	OK
Upward-facing mounting	Incorrect
Other mounting directions	Incorrect

• Mounting Space

The long-term reliability of the S8M can be increased by installing it properly and sufficiently considering heat dissipation. Install the S8M so that the air flow circulates around it, because the S8M is designed to radiate heat by means of natural air circulation.

Although two or more S8M Multicircuit Protectors can be installed side by side, they must be separated from sources of heat, such as the switching power supply installed to the input side, by the distances given in *3-1 Installation Environment*.

■ Input Voltage

Input voltage range: 19.2 to 26.4 VDC

- The S8M provides abnormal voltage protection. All branch outputs will be cut off if the input voltage exceeds 28.8 VDC. This function, however, does not protect loads and internal parts from high voltages in all cases. Be sure the input voltage is within the rated range.
- Outputs may be cut off by the abnormal voltage protection with loads that generate reverse peak electro-motive force.
- A voltage drop occurs within the S8M. Be sure to consider the effect of the voltage drop on the output voltage.

■ Input Power Supply Selection

- When selecting a power supply, be sure to add the S8M's internal power consumption (about 10 W) to the power consumption of the loads.
- The overcurrent protection characteristics of the power supply connected to the input side can cause a voltage drop, possibly resulting in a cutoff.
- If the capacity of the input power supply is too small compared with the load, the overcurrent protection characteristics of the power supply can prevent the S8M from starting or can cause a voltage drop, possibly resulting in a cutoff.
- If secondary voltage of the power supply rises or falls too slowly, the overcurrent protection characteristics of the power supply can prevent the S8M from starting or can cause a voltage drop, possibly resulting in a cutoff.

■ Tripping Performance

There are two tripping types that can be used to detect output current characteristics: Standard detection (overcurrents lasting 80 ms are cutoff within 100 ms) and Instantaneous detection (overcurrents lasting 20 ms are cutoff within 10 ms). Set the best tripping output current characteristics.

- If the S8M is tripped, always remove the cause first and then reset the S8M.
- If using a load with a fixed power operation, a cutoff may occur when the power supply is turned OFF.
- The accuracy of the tripping current is ± 0.3 A.

■ Startup Delay

To prevent cutoffs caused by large surge currents when the equipment starts, the S8M has a startup delay that disables the tripping operation for 70 ms after the semiconductor relay turns ON.

- The startup delay will not operate when a relay or other device is used for ON/OFF control on the output side of the S8M, so a tripping operation may occasionally occur.

■ Withstand Voltage Test

The S8M is designed to withstand 500 VAC for 1 minute between the power input terminals and all branch output terminals, between all signal output terminals and all external tripping input terminals, between all signal output terminals and all communications terminals, and between all external tripping input terminals and all communications terminals.

- Note**
- The S8M may possibly be damaged from the impulse voltage if a testing device switch is used to abruptly apply or shut off 500 VAC. Increase the applied voltage gradually using the voltage adjustment on the testing device.
 - Always short the specified terminals so that the voltage is applied to all of the terminals at the same time.
 - The power input terminals and branch output terminals are not isolated. Do not perform dielectric strength tests between the input and output terminals.

■ Voltage Display

The voltage detection function monitors the voltage at the power input terminals. Measure the voltage at the branch outputs to confirm that the output voltage is correct.

■ Series Connections

An S8M cannot be connected in series to another S8M's output and branch outputs cannot be connected in series.

- Do not connect S8Ms in series.

Incorrect

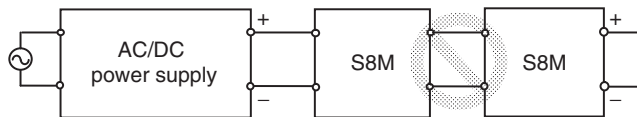

- Do not connect S8M branch outputs in series.

Incorrect

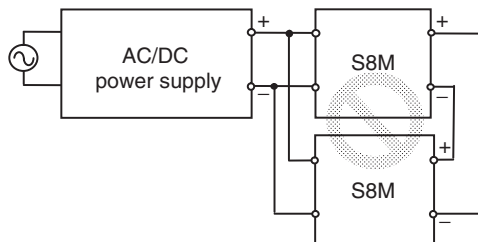

Incorrect



■ Parallel Connections

An S8M cannot be connected in parallel with another S8M's output and branch outputs cannot be connected in parallel.

- Do not connect branch outputs in parallel.

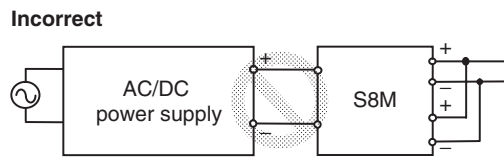
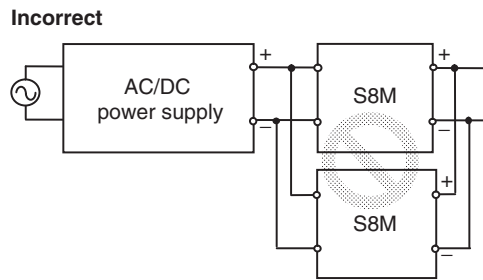

■ Backup Device Connections

Observe the following precautions when using a backup device, such as one from OMRON's S8T Series.

- If a backup device is connected to an S8M branch output, the backup current will be supplied to other branches through internal circuits and internal parts may also be deteriorated or damaged. When using a backup device with the S8M, connect the backup device to the power input side.
- When connecting a backup device to the S8M input side, the backup time will be shorter than normal due to internal power consumption. Always confirm the backup time when using a backup device.

■ Terminal Block Plating

The tripping alarm output, alarm output, over-temperature output, and external tripping input terminals, as well as the connecting sections of the communications terminals, are gold-plated. If connection failures occur, we recommend making connections with the wires made from the same material.

Using this Manual

■ Notation in this Manual

There are three models of S8M Digital Multicircuit Protectors covered in this manual: the S8M-CP04 (model without an RS-232C port), S8M-CP04-R, and S8M-CP04-RS (UL Class 2 output model). These are collectively referred to as the S8M. The functions and specifications described in this manual are shared by all three models, unless differences are mentioned specifically.

■ Notation of Setting Data

Setting data codes and contents are displayed in seven-segment display characters, as shown in the following diagram.

<i>A</i>	<i>b</i>	<i>c</i>	<i>d</i>	<i>E</i>	<i>F</i>	<i>G</i>	<i>H</i>	<i>i</i>	<i>j</i>	<i>K</i>	<i>L</i>	<i>m</i>
A	B	C	D	E	F	G	H	I	J	K	L	M

<i>n</i>	<i>o</i>	<i>P</i>	<i>q</i>	<i>r</i>	<i>S</i>	<i>t</i>	<i>U</i>	<i>v</i>	<i>w</i>	<i>x</i>	<i>Y</i>	<i>Z</i>
N	O	P	Q	R	S	T	U	V	W	X	Y	Z

SECTION 1

Features and Functions

This section describes the features and functions of the S8M.

1-1	Overview of Features and Functions.	2
1-2	S8M Operations and Operating Modes.	7
1-3	Table of Basic Functions.	10
1-4	S8M Operating Procedure.	11

1-1 Overview of Features and Functions

The S8M Digital Multicircuit Protector incorporates four circuit protectors in one package. The four 24-VDC, semiconductor relay circuit protectors can be set digitally.

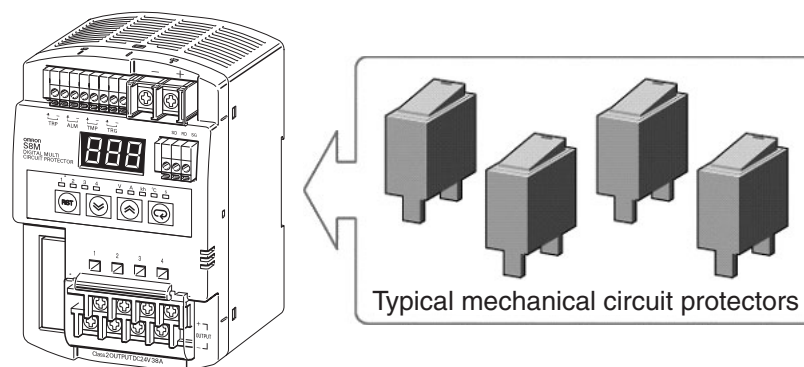

Unlike mechanical circuit protectors, the S8M is equipped with the following functions that use digital processing and provide a variety of advantages.

Connection and Tripping Operations Using Semiconductor Relays

The four branch outputs are independent of each other and are connected/cut off by semiconductor relays. In comparison to traditional mechanical circuit protectors, the semiconductor relays are not consumable parts, so they have a long lifetime.

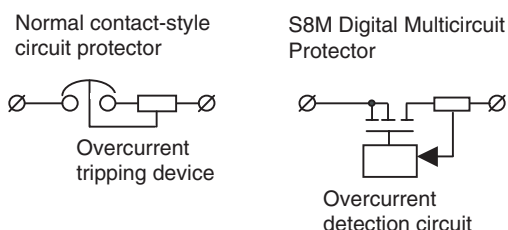

Tripping Output Current Can Be Set in 0.1-A Units

The S8M is a digital device, so each branch output's tripping current can be set freely between 0.5 and 4.0 A (0.5 to 3.8 A for the S8M-CP04-RS). The abnormal current tripping value and overcurrent alarm value can be set as the circuit protector's rated currents. In addition, the tripping type can be set to standard detection (tripping within 100 ms) or instantaneous detection (tripping within 20 ms).

Voltage, Temperature, and Run Time Can Also Be Monitored

The S8M monitors the input voltage, internal temperature, and run time, along with the input current. The input current, input voltage, and internal temperature measurements are continuously converted from analog to digital and these values, as well as the run time, are compared to preset parameters. If a value exceeds the corresponding set value, the output will be cut off or an alarm will be output and the error will be indicated on the seven-segment display. These functions increase the device's added value, while also providing important maintenance information.

Monitoring Operation with the Seven-segment Display

The S8M continuously converts the input voltage, current, and internal temperature from analog to digital. These values, as well as the run time, can be checked easily on the S8M's seven-segment display.

Error Display and Tripping Functions

When the input voltage, current, internal temperature, or run time exceeds the set value, the error code will be displayed on the seven-segment display and the branch output will be cut off or an alarm will be output and the branch output will remain connected. Error codes are displaying in order of their severity, so the source of the error can be isolated quickly.

Three S8M Models Available

There are three models of the S8M Digital Multicircuit Protector available, as shown in the following table. The models share the same performance and basic functions such as tripping and alarms, but differ in the internal circuit configuration (see note 2) and communications ports. Select the appropriate model for your application.

Model	RS-232C port	Redundant tripping circuits
S8M-CP04-R	Yes	No
S8M-CP04-RS	Yes	Yes
S8M-CP04	No	No

- Note**
- (1) The Support Tool cannot be used with the S8M-CP04, which is not equipped with a communications port.
 - (2) Refer to 2-2 *Internal Configuration* for internal circuit block diagrams.

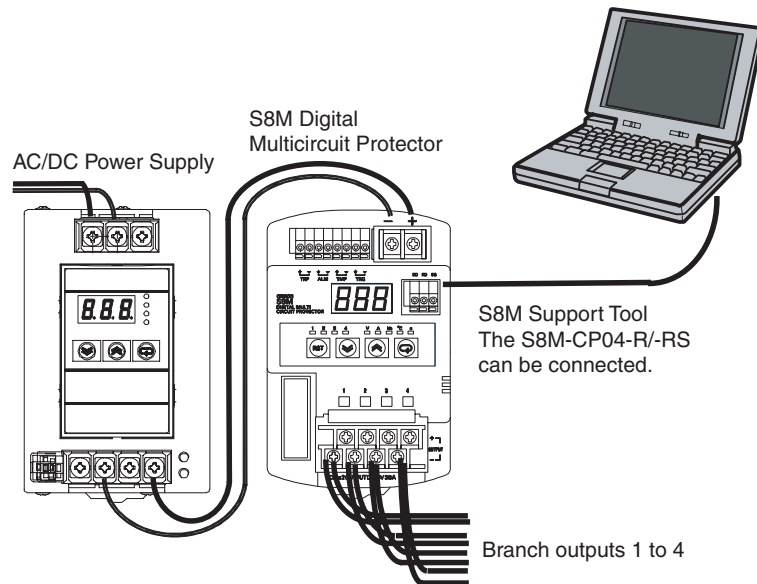

Basic Functions

Tripping Functions

The branch output is cut off when an abnormal voltage or abnormal current is detected. In this case, the tripping alarm output will be turned OFF and the corresponding error code will be shown on the seven-segment display. (For details, refer to 2-4 *Basic Function Details*.)

Abnormal voltage tripping	When the power supply voltage exceeds 28.8 V, all of the branch outputs will be cut off by the semiconductor relays. The S8M system monitors the voltage, so it is not necessary to set parameters.
Abnormal current tripping	When a branch output's current exceeds the set value, that output is cut off by its semiconductor relay. The tripping type for abnormal current detection can be set to standard detection (tripping within 100 ms) or instantaneous detection (tripping within 20 ms).

The S8M-CP04-RS (UL Class 2 output model) has redundant tripping circuits. In addition to the regular abnormal current tripping function (0.5 to 3.8 A) that is set with a parameter, there is a built-in system tripping circuit that detects currents over 4.0 A.

Safety Functions

All S8M models are equipped with a short-circuit protection fuse and thermal fuse to provide protection.

External Outputs

The S8M has 3 external outputs: the Tripping Alarm Output (TRP), Alarm Output (ALM), and Over-temperature Output (TMP).

The Tripping Alarm Output is output when an abnormal current or abnormal voltage is detected. The Alarm Output is output when there is an overcurrent, overvoltage, undervoltage, or excessive run time. The Over-temperature Output is output when the temperature exceeds the rated temperature.

Tripping Alarm Output (TRP)	<ul style="list-style-type: none"> • An abnormal voltage over 28.8 V was detected. • A current exceeding the abnormal current tripping value was detected. 	The output status is retained when power is interrupted but can reset with the reset operation.
Alarm Output (ALM)	<ul style="list-style-type: none"> • A voltage below the undervoltage alarm value was detected. • A voltage over the overvoltage alarm value was detected. • A current over the overcurrent alarm value was detected. • The run time exceeded the run time value. 	This output can be reset with the reset operation. If the alarm is cleared when the power is turned ON, the output will be reset.
Over-temperature Output (TMP)	A temperature exceeding the over-temperature output value was detected.	The output is reset automatically when the temperature falls to 3°C below the over-temperature output value.

Tripping Functions Using External Signals

Branch outputs can be forcibly cut off by turning ON the External Tripping Input (TRG).

- Tripping using the External Tripping Input can be enabled or disabled independently for each branch output. A branch output will be cut off only when this function is enabled.
- The External Tripping Input directly cuts off a branch output's DC circuit, so it acts even faster than cutting off the output by turning OFF the normal AC power supply.
- When a shutdown sequence has been set, this function can be used to set a time lag for the branch output cutoff. (For details, refer to *2-6 Shutdown Sequence Function*.)

Additional Functions

Startup Sequence Function

A delay can be set for the connection of the four branch outputs. When you want to apply a startup delay to the branch output, it is not necessary to construct an external sequence circuit. The inrush current can be suppressed by applying a delay and the Power Supply Unit's capacity can be reduced. (For details, refer to *2-5 Startup Sequence Function*.)

Shutdown Sequence Function

When an external input is used to cut off an output, the four branch outputs' cutoff can be delayed. When you want to apply a shutdown delay to the branch output, it is not necessary to construct an external sequence circuit. (For details, refer to *2-6 Shutdown Sequence Function*.)

Monitoring Temperature Rise (TMP Output)

The S8M has a built-in temperature sensor and the Over-temperature Output (TMP) will be turned OFF when the internal temperature exceeds the set value. This output can also be used to start a cooling fan or air conditioner to reduce the temperature in the control panel. (For details, refer to 2-4-3 *Over-temperature Output*.)

Monitoring the Run Time

A Run Time Value can be set and used for periodic maintenance of the equipment. The default setting is 0.0 kh, which disables the alarm output. (For details, refer to 2-4-4 *Run Time Alarm*.)

Protecting Parameter Settings

The Protection Level can be set to restrict access to the parameters. Three levels, levels 0, 1, and 2, are available. This function can be used to prevent parameters from being changed or deleted inadvertently. (For details, refer to 4-4 *Changing the Protection Level*.)

Protection level 0	There are no restrictions on reading and changing the parameter settings.
Protection level 1	Permits only reading and changing of the input voltage, current, internal temperature, and run time parameters.
Protection level 2	Permits only reading of the input voltage, current, internal temperature, and run time parameters.

The default setting is protection level 1.

Support Tool Available

S8M Support Tool is available and can be connected to the S8M-CP04-R and S8M-CP04-RS. The Support Tool simplifies system startup and maintenance because it allows the user to set the various parameters, monitor operation, save settings data, and copy parameters to other S8M Multicircuit Protectors. The Support Tool can be downloaded from OMRON's home page free of charge. (For details on the Support Tool, refer to *SECTION 6 Support Tool*.)

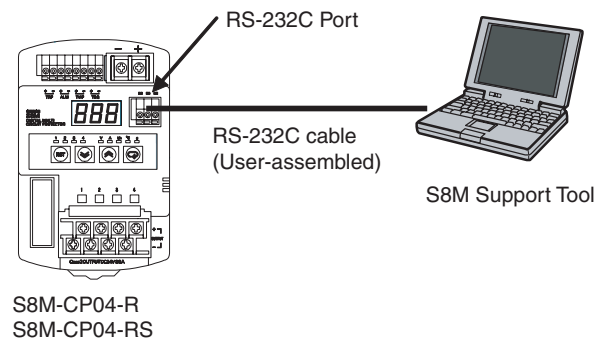

Connecting to a Network

The RS-232C port on the S8M-CP04-R and S8M-CP04-RS can be connected to a host computer via CompoWay/F (see note 1).

FINS commands (see note 2) can be used to perform operations over the network, such as reading settings data, sending operating commands, and switching setting levels.

- Note**
- (1) CompoWay/F is one of OMRON's general-purpose FA networks.
 - (2) FINS is OMRON's general-purpose FA protocol.

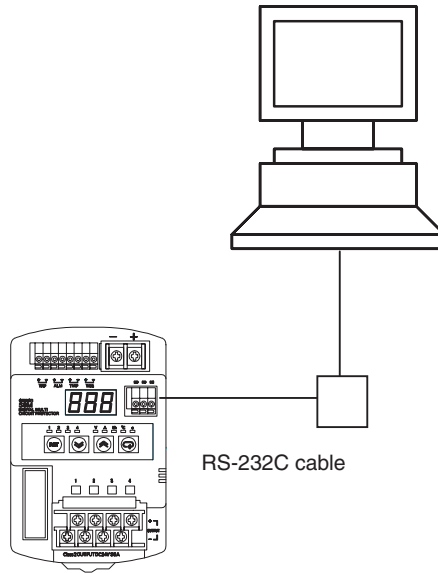

1-2 S8M Operations and Operating Modes

The S8M has 3 operating modes: Run Mode, Setting Mode, and Test Mode.

Run Mode	Branch outputs are connected while monitoring the input voltage, current, internal temperature, and run time. The monitored PV is displayed on the seven-segment display and can be read with key operations.
Setting Mode	This mode is used to set parameters. Branch output connections are the same as in Run Mode. The S8M automatically starts in Setting Mode when the S8M is used for the first time.
Test Mode	This mode is used to test operation. The factory default setting for all outputs is OFF, so the branch outputs being used must be turned ON in Test Mode.

Note When the Support Tool is connected, the S8M can be operated and parameters can be set/changed regardless of the S8M's operating mode.

Changing the Operating Mode

Turning the Power ON for the First Time

The operating mode can be changed from the Mode Selection Menu using the Up and Down Keys.

- A newly purchased S8M will automatically enter Setting Mode when it is turned ON for the first time. Refer to *SECTION 4 Parameter Settings* for details on setting parameters in Setting Mode.
- When starting operation or setting branch output connections after setting the parameters, return to the Mode Selection Menu and switch to Test Mode. Refer to *SECTION 5 Trial Operation to Actual Operation* for details on the operations in Test Mode.
- When changing to Run Mode after completing the trial run, return to the Mode Selection Menu and switch to Run Mode. If the power is turned OFF while the S8M is in Test Mode, the S8M will enter Test Mode again the next time that the power is turned ON. In this case, all branch outputs will be OFF (not connected).

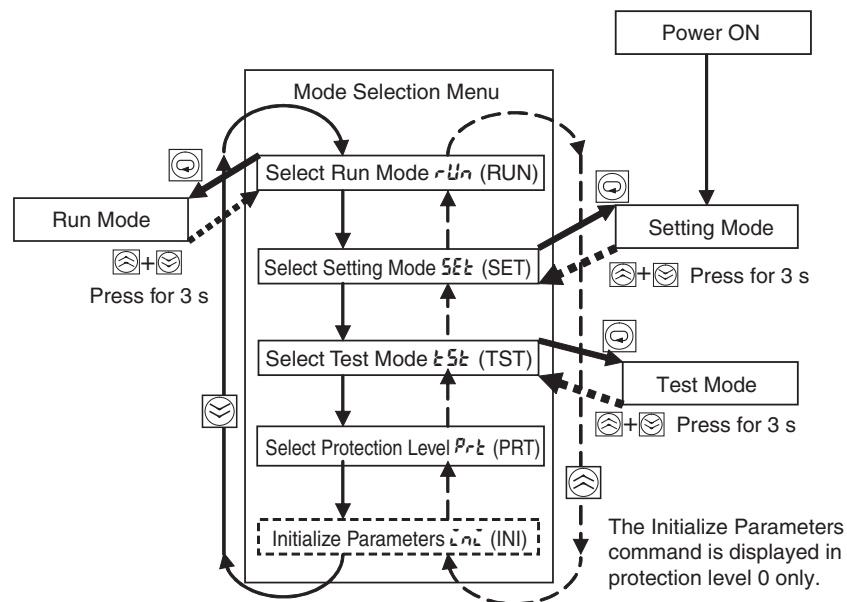

Normal Power-ON Procedure

If the S8M has been turned ON already, it will enter Run Mode or Test Mode the next time that power is turned ON. If the S8M was in Test Mode when the power went OFF, it will start in Test Mode. If it was in a mode other than Test Mode when the power went OFF, it will start in Run Mode.

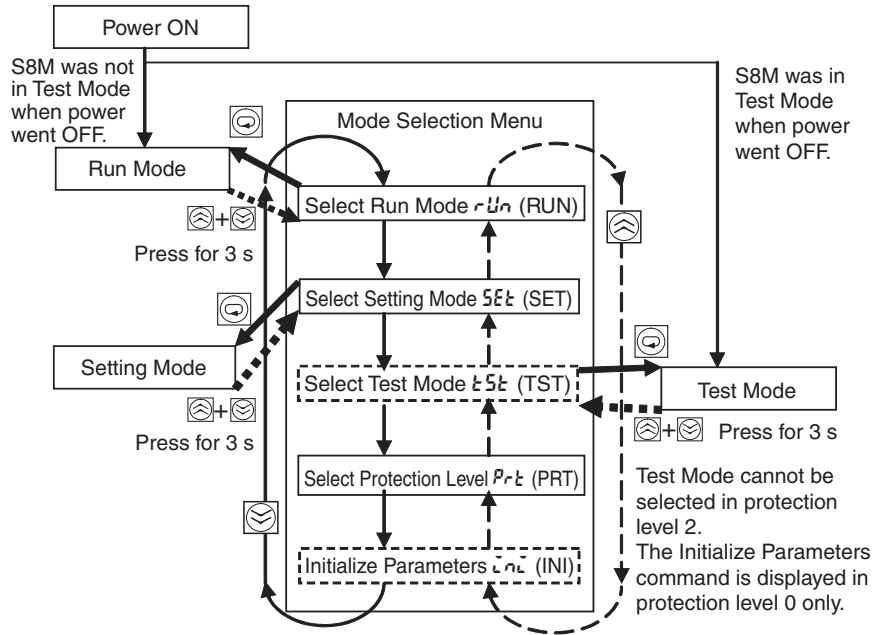

In addition to selecting the operating mode, the Mode Selection Menu can be used to select the protection level (see note 1) and initialize the parameters (see note 2).

- Note**
- (1) The Protection Level function can restrict parameter read/write access to one of three levels. For details, refer to 4-4 *Changing the Protection Level*.
 - (2) The Initialize Parameters function restores all of the S8M's parameter settings to their default values. For details on default values, refer to 4-2 *Parameter Setting Ranges*.

Automatic Operation after Power ON

When a 24 VDC power supply is connected to the input terminal block, the S8M performs self-diagnostics. If no errors are detected, the S8M immediately starts connecting the branch outputs.

Branch outputs will not be connected (ON) if they were not set to ON in Test Mode. Furthermore, if the startup sequence function (see 2-5 *Startup Sequence Function*) has been set, the outputs will be connected in order according to their corresponding set times.

Operation in Run Mode

In Run Mode, the S8M continuously converts the input voltage, current, run time, and internal temperature from analog to digital and compares these present values to the set values (both user-set parameters and system set values). These values can be read on the S8M's seven-segment display and the displayed value can be switched with the Up Key (⬆) and Down Key (⬇).

Tripping Operation

When the voltage or current is abnormal, the branch output is cut off and the Tripping Alarm Output (TRP) is turned OFF.

Alarm Operation

When the converted input voltage, current, internal temperature, or run time exceeds the set value, the output will be cut off or an alarm will be output and the error indicated on the Alarm Output (ALM) will be turned OFF. (The Over-temperature Output (TMP) will also be turned OFF if the temperature exceeds the set value.)

Operation in Setting Mode

Setting Mode can be used to set the various parameters, but the S8M connects to branch outputs in Setting Mode, just as it does in Run Mode. When an error is detected, branch outputs will be cut off and external signals will be output, just as they are in Run Mode.

Note If an error occurs in Setting Mode, the error code is not displayed and the error cannot be reset. To reset the error, first switch the operating mode to Run Mode and then reset the error.

Operation in Test Mode

In Test Mode, each branch output can be set to ON or OFF (connected or disconnected). In addition, the operation of the startup sequence and shutdown sequence can be verified.

- The output connection status does not change when the operating mode is switched from Run Mode to Test Mode.
- If a branch output is OFF (disconnected) in Test Mode, it will not go ON even when the operating mode is changed to Run Mode.
If you want to set unused branch outputs to OFF, set those outputs to OFF in Test Mode before switching to Run Mode.
- If the power is turned OFF while the S8M is in Test Mode, the S8M will start in Test Mode the next time that the power is turned ON.

Note When an error occurs in Test Mode, branch outputs will be cut off and external signals will be output, just as they are in Run Mode. On the other hand, the error code will not be displayed and the error cannot be reset. To reset the error, first switch the operating mode to Run Mode and then reset the error.

- Note**
- (1) When the S8M is shipped from the factory, all branch outputs are set to OFF (disconnected). A newly purchased S8M will automatically enter Setting Mode when it is turned ON for the first time. After setting the parameters, switch to Test Mode, connect the branch outputs that will be used, and then switch to Run Mode.
 - (2) If a branch output is OFF (disconnected) when the mode is changed from Test Mode to Run Mode, it will not be connected (ON) in Run Mode.
 - (3) If the power is turned OFF while the S8M is in Test Mode, the S8M will start in Test Mode the next time that the power is turned ON, but all branch outputs will be OFF.

Operation with Support Tool Connected

The S8M will be operational even when parameters are being set with the Support Tool.

If data is downloaded from the Support Tool (parameters transferred from the Support Tool to the S8M), the parameters in the S8M will be updated immediately.

1-3 Table of Basic Functions

There are three ways for the S8M's tripping function to operate: tripping by user-set parameters, tripping by the S8M's system monitor, and tripping by external operation.

There are three outputs: the Tripping Alarm Output, Alarm Output, and Over-temperature Output.

Tripping/Alarm Functions

Setting	Operating range	Parameter settings	Outputs cut off	External output	Error code displayed
Abnormal voltage tripping	Automatically trips for voltage over 28.8 VDC for more than 10 ms.	None	All branch outputs	TRP output OFF	A10
Short-circuit current tripping	9.0 A for more than 10 ms	None	Individual branch output	TRP output OFF	A11
	S8M-CP04-RS only: Trips within 0.5 s for current over 4.0 A. (See note 1.)	None	Individual branch output	TRP output OFF	A11/Current (alternating)
Abnormal current tripping (See note 2.)	S8M-CP04-R and S8M-CP04: 0.5 to 4.0 A (in 0.1 A units)	None	Individual branch output	TRP output OFF	A11/Current (alternating)
	S8M-CP04-RS: 0.5 to 3.8 A (in 0.1 A units)				
Overvoltage alarm	20.0 to 28.8 VDC (in 0.1 V units)	None	None	ALM output OFF	A20/Voltage (alternating)
Undervoltage alarm	18.0 to 26.4 VDC (in 0.1 V units)	None			A21/Voltage (alternating)
Overcurrent alarm (See note 3.)	S8M-CP04-R and S8M-CP04: 0.5 to 4.0 A (in 0.1 A units)	None	None	ALM output OFF	A22/Current (alternating)
	S8M-CP04-RS: 0.5 to 3.8 A (in 0.1 A units)				
Run time	0.0 to 99.9 kh (99,900 hours \approx 11.4 years, see note 4)	None	None	ALM output OFF	A23/Time (alternating)
Over-temperature output	25 to 80°C Set value + 1°C for 1 s continuously	None	None	TMP output OFF	A30/Temperature (alternating)
External tripping input	External input signal (TRG) ON	Specified output (See note 5.)		---	TRG
Support Tool	Click the Connect Output Buttons for the desired outputs in the Present Values Window.			---	---

- Note**
- (1) There are redundant overcurrent protection functions in the S8M-CP04-RS.
 - (2) The tripping function operates within 100 ms when the S8M is set to standard detection and within 20 ms when it is set to instantaneous detection.
 - (3) The alarm is output within 100 ms when the S8M is set to standard detection and within 20 ms when it is set to instantaneous detection.
 - (4) Run time alarms are disabled when the time parameter is set to 0.0 kh.
 - (5) The TRG signal applies only to the branch outputs for which the external tripping input is enabled. For details, refer to page 67.

1-4 S8M Operating Procedure

Using the S8M

Typical Startup Procedure Using the S8M's Keys

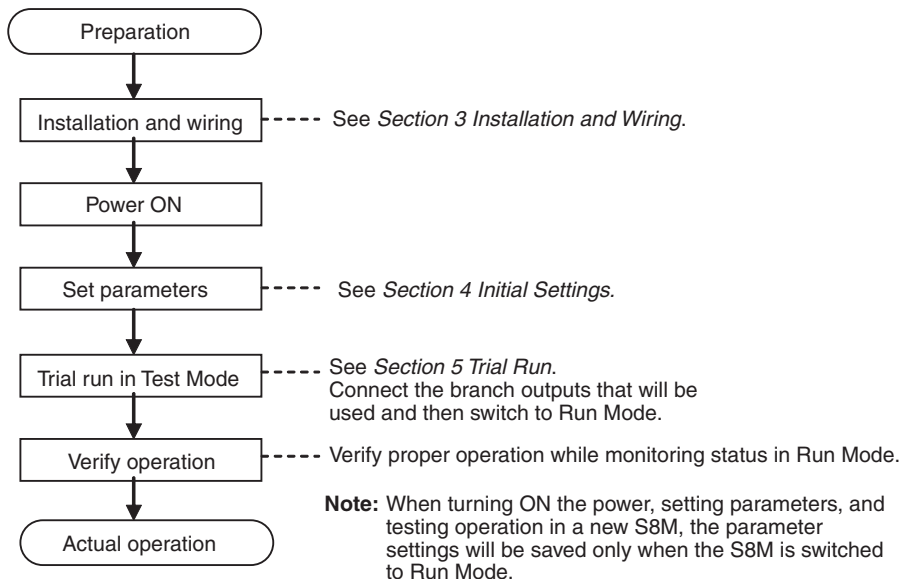

Typical Startup Procedure Using the Support Tool

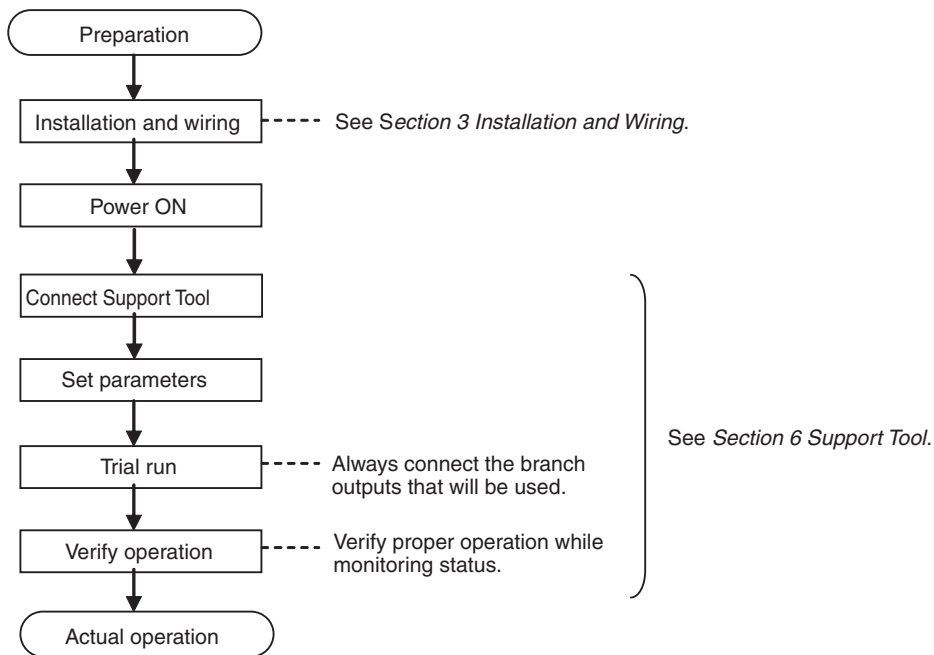

Summary of Application Objectives and Settings

Desired objective/usage	Settings	Details
Use as a circuit breaker with overcurrent tripping.	In Setting Mode, set the tripping current value (C-V) for the branch output being used and set the abnormal current tripping detection setting (C-T) to standard detection (USU).	56, 58
Use as a circuit breaker for short-circuit current protection.	In Setting Mode, set the tripping current value (C-V) for the branch output being used and set the abnormal current tripping detection setting (C-T) to instantaneous detection (INS).	
Output an alarm when output is cut off due to overcurrent.	Take the alarm signal from the Tripping Alarm Output (TRP) terminal. When an output is cut off, the seven-segment display will show error code A11 and the TRP output will go OFF.	56, 58, 40
Output an alarm before output is cut off due to overcurrent.	In Setting Mode, set the overcurrent alarm value (A-V) for the branch output being used and set the overcurrent alarm detection setting (A-T) to standard detection (USU) or instantaneous detection (INS). Take the alarm signal from the Alarm Output (ALM) terminal. When an overcurrent is detected, the seven-segment display will show error code A22 and the ALM output will go OFF.	58, 59, 40
Detect power supply overvoltage.	In Setting Mode, set the overvoltage alarm value (V-O). Take the alarm signal from the Alarm Output (ALM) terminal. When an overvoltage is detected, the seven-segment display will show error code A20 and the ALM output will go OFF.	61
Detect a drop in power supply voltage.	In Setting Mode, set the undervoltage alarm value (V-U). Take the alarm signal from the Alarm Output (ALM) terminal. When an overvoltage is detected, the seven-segment display will show error code A21 and the ALM output will go OFF.	61, 40
Apply a separate time lag when connecting each branch output.	In Setting Mode, set the startup sequence (UPS).	64, 30
Apply a separate time lag when cutting off each branch output.	In Setting Mode, set the shutdown sequence (DWS) and enable the External Tripping Input (TRG).	65, 66, 31
Perform a system inspection after a fixed run time.	In Setting Mode, set the desired run time (TIM). Take the alarm signal from the Alarm Output (ALM) terminal. When the preset run time is reached, the seven-segment display will show error code A23 and the ALM output will go OFF.	71, 30 41
Reset the run time.	In Setting Mode, select the Clear Run Time command (CLR).	71
Monitor temperature rise in control panel and prevent overheating.	In Setting Mode, set the over-temperature output value (TMP). Take the signal from the Over-temperature Output (TMP) terminal and use that signal to operate a fan or air conditioner.	61, 28, 41
Restrict read/write access of parameters to prevent mistaken operations.	Select the protection level setting (PRT) from the Mode Selection Menu and set the desired protection level.	54
Ensure normal operation for other devices connected to a power supply to which a device with a short-circuit is connected. (Prevent voltage drops due to short-circuits.)	To achieve this, extra current capacity is required in the Power Supply Unit connected to the S8M. Select a Power Supply Unit with a current capacity that is 10 to 12 A higher than the maximum current supply to the connected devices. Use the total current display in Run Mode to confirm if the selected Power Supply Unit satisfies this condition.	39, 79

SECTION 2

Specifications and Functions

This section provides the specifications of the S8M and describes special S8M functions.

2-1	Component Names and Functions	14
2-2	Internal Configuration	16
2-3	Specifications	18
2-4	Basic Function Details	22
2-4-1	Current Protection Functions	22
2-4-2	Overvoltage/Undervoltage Protection Function	26
2-4-3	Over-temperature Output	28
2-4-4	Run Time Alarm	30
2-5	Startup Sequence Function	30
2-6	Shutdown Sequence Function	31

2-1 Component Names and Functions

Component Names

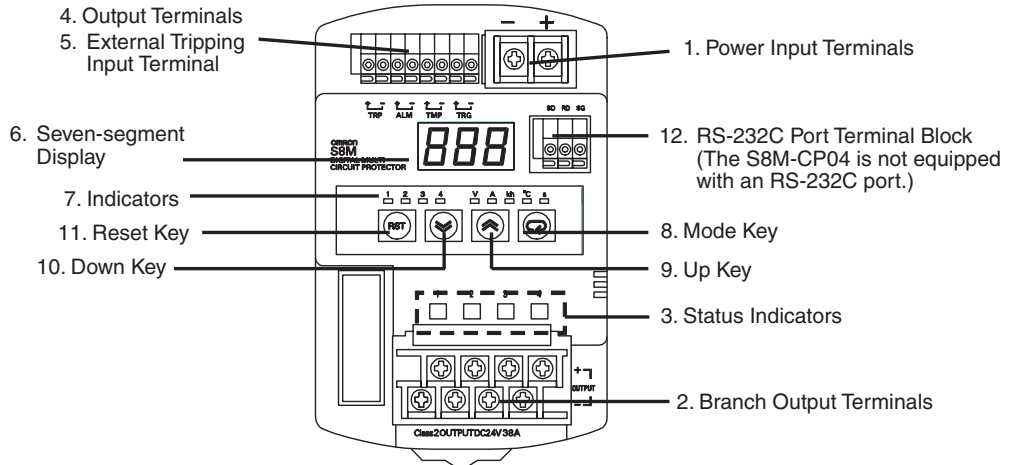

1. Power Input Terminal Block (+V and -V)
Connect to the 24 VDC input power supply. (The terminal screws are M4.)
2. Branch Output Terminal Block (+V and -V)
Connect to each branch output. (The terminal screws are M3.5.)
3. Status Indicators (Red or Green)
Indicate the connection and cutoff status for each branch output.

Not lit	Not connected	Set to OFF (disconnected) or forcibly cut off by command.
Lit green	Connected	Connected normally.
Flashing green	Not connected	In the startup sequence and waiting for connection.
Lit red	Cut off	Cut off due to an error.
Flashing red	Cut off	Cut off by the redundant protection circuit required for a UL Class 2 output (S8M-CP04-RS only).

4. External Output Terminals and 5. External Tripping Input Terminal

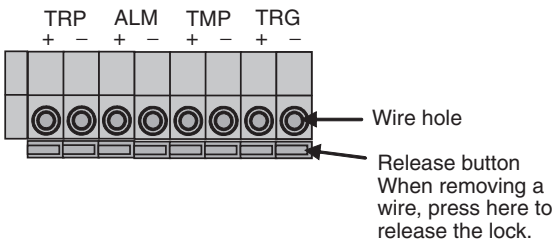

4	TRP	Tripping Alarm Output	OFF to indicate when an abnormal voltage or current was detected and the output was cut off. (Transistor OFF)
	ALM	Alarm Output	OFF to indicate that the input voltage, current, or run time exceeded the alarm value. (Transistor OFF)
	TMP	Over-temperature Output	OFF to indicate that the temperature exceeded the over-temperature output value. (Transistor OFF)
5	TRG	External Tripping Input	Can be used to send an input signal from an external device to cut off a branch output.

6. Seven-segment Display (Red)
Displays measured values or set values on a 3-digit LED display.

7. Indicators (Orange)

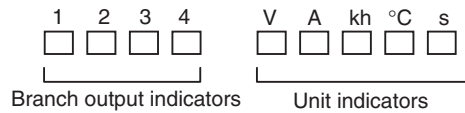

1 to 4	An indicator will light or flash when the display is related to the corresponding branch output.
V	Lit when displaying the input voltage.
A	Lit when displaying the output current. Flashes when displaying the peak output current.
kh	Lit when displaying the run time. The seven-segment display shows the time in 0.1-kh (100-h) units.
°C	Lit when displaying the temperature.
s	Lit when setting the startup sequence time or shutdown sequence time.

8. to 11. Operation Keys

8		Mode Key	Used to set the parameter being displayed, clear the peak hold current value, and register settings.
9		Up Key	Used to move to different setting modes or to increment a set value.
10		Down Key	Used to move to different setting modes or to decrement a set value.
11		Reset Key	Used to clear an alarm output or connect a branch output that was cut off by an error or external tripping input. The Reset Key cannot connect an output that was set to OFF (not connected) in Test Mode or cut off by a command via RS-232C communications.

12. RS-232C Port Terminal Block (RD, SD, and SG)

Connect to the communications lines (RS-232C). The terminal block has screwless terminals. The S8M-CP04 (model without communications) does not have these RS-232C terminals.

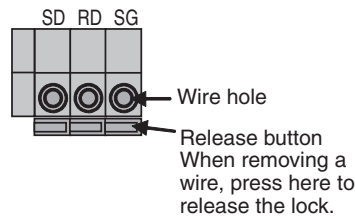

2-2 Internal Configuration

S8M-CP04-R

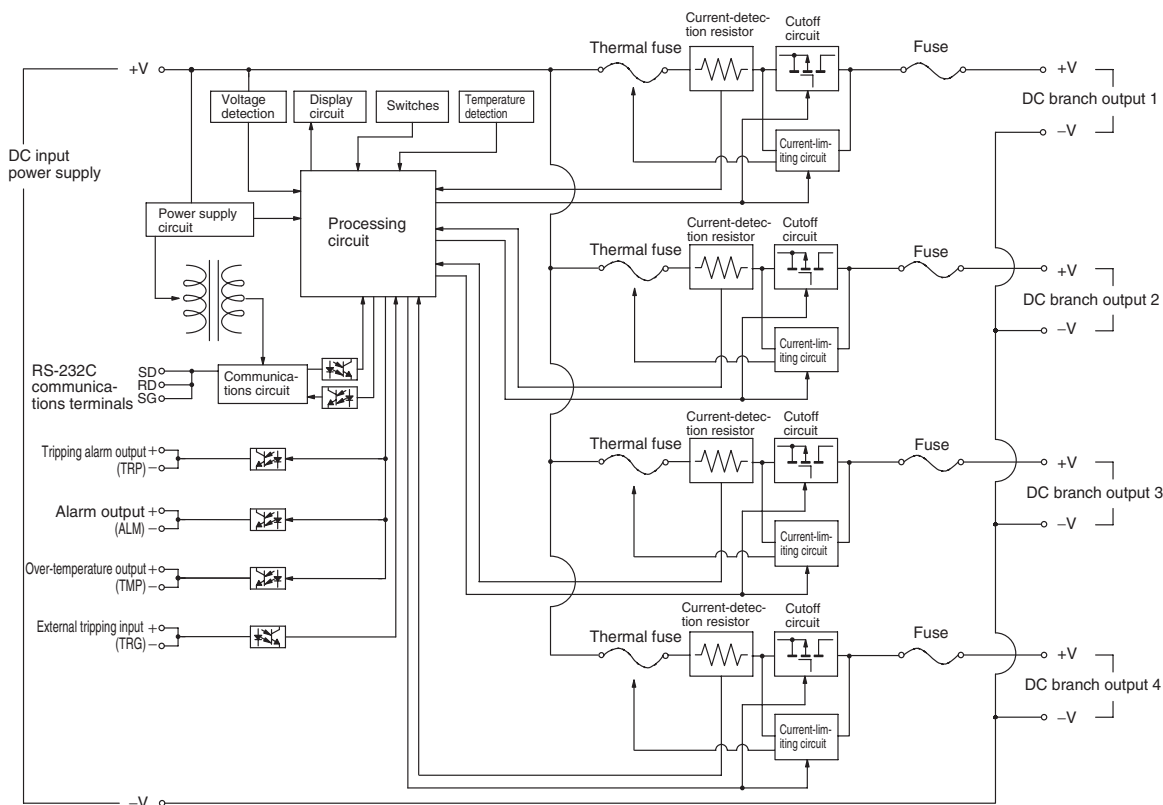

- The S8M continuously converts the measured input voltage, current, internal temperature, and run time from analog to digital and compares these measured values to the preset parameters. These values can be read on the S8M's seven-segment display or monitored remotely from the Support Tool connected via the RS-232C port.
- When an error is detected, the branch output will be cut off or an alarm will be output. The error code and PV will be displayed alternately on the seven-segment display. The information can also be read from the Support Tool.
- When an abnormal voltage or current is detected, the semiconductor relay will cut off the branch output. In the unlikely event that the semiconductor relay cannot cut off an abnormal current or short-circuit current, the short-circuit protection fuse (8.0 A minimum) will blow to protect the system.
- The S8M has a built-in temperature sensor, which can detect a temperature rise inside the S8M. When the internal temperature exceeds the alarm value, the Over-temperature Output (TMP) will be turned OFF. The TMP output is independent of the alarm output, so it can be used to control cooling equipment to reduce the temperature in the control panel.
- The equipment's run time can be monitored in 0.1-kh (100-hour) units by measuring the S8M's run time.
- When an internal circuit has failed, the components can generate excessive heat. As a safety precaution against this kind of failure, the S8M is equipped with a function that cuts off operation using a thermal fuse.

S8M-CP04-RS (UL Class 2 Output Model)

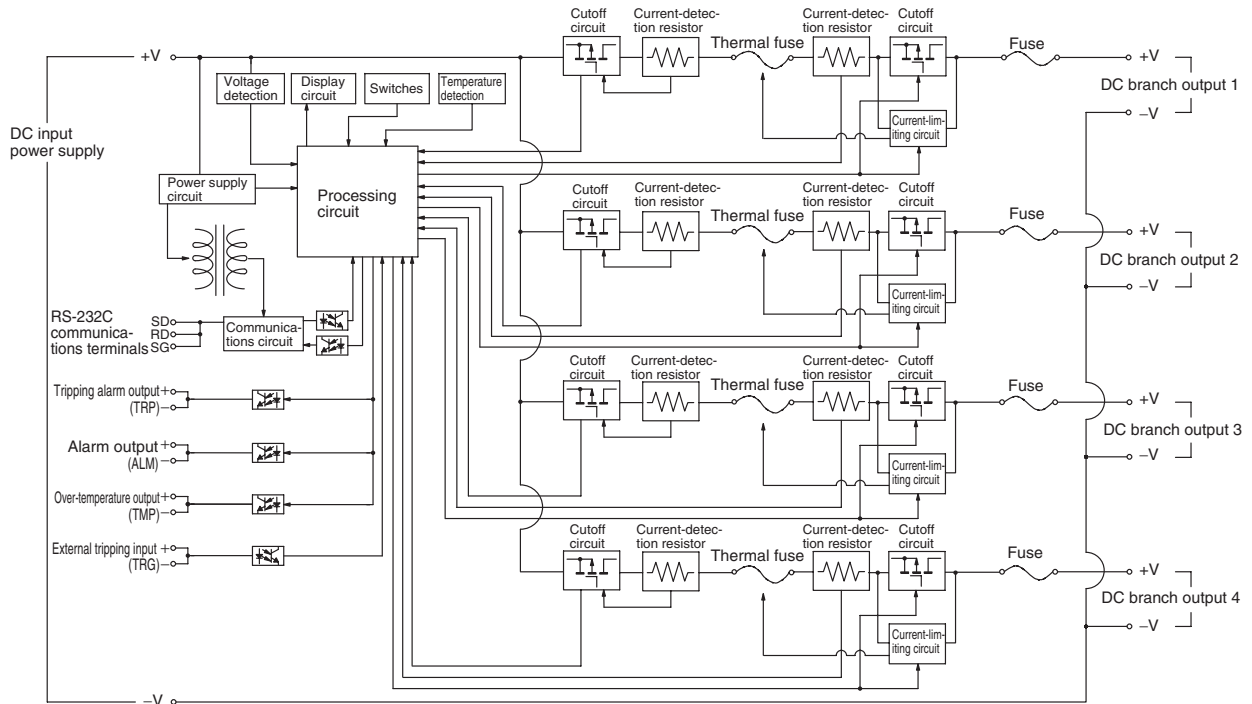

In addition to the regular cutoff circuits (cutoffs for abnormal current, abnormal voltage, etc.), the UL Class 2 output model has a cutoff circuit that detects only overcurrents of 4.0 A or higher and cuts off the output.

S8M-CP04 (Model without Communications)

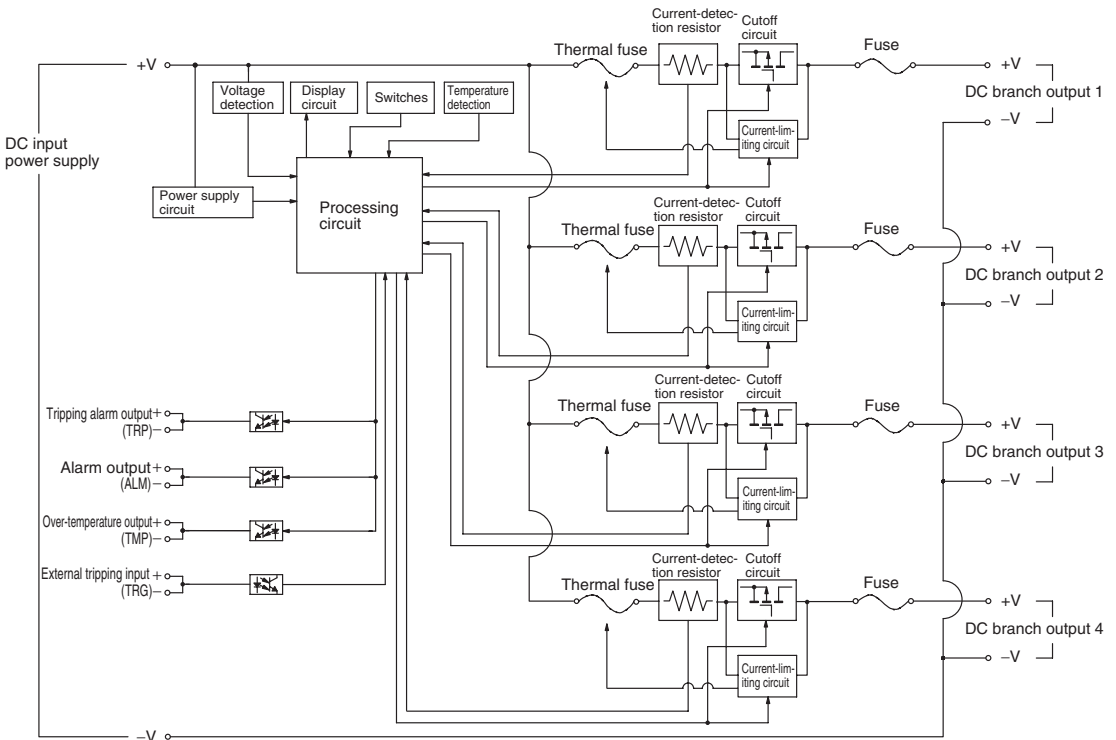

This model has the same basic functions and configuration as the standard model, but does not have an RS-232C port so it cannot connect to the Support Tool.

2-3 Specifications

Ratings and Characteristics

Item	Model	S8M-CP04	S8M-CP04-R	S8M-CP04-RS	
Number of branches		4			
I/O characteristics	Rated input voltage		24 VDC (19.2 to 26.4 VDC)		
	Allowable input current		17.0 A max.	16.0 A max.	
	Maximum shutoff output current (per branch)		4.0 A	3.8 A	
	Internal voltage drop		0.5 VDC max. (at 4.0 A)	0.7 VDC max. (at 3.8 A)	
	Output leakage current		10 mA max.		
	Power consumption	4 branches output, normal operation	10 W max. (at 4.0 A)		15 W max.
4 branches output, outputs cut off		3 W max.			
Functions	Tripping functions	Abnormal voltage tripping	28.8 V (fixed), Tripping Alarm Output (TRP) OFF		
		Abnormal current tripping	Setting range: 0.5 to 4.0 A (in 0.1-A units), Tripping Alarm Output OFF	Setting range: 0.5 to 3.8 A (in 0.1-A units), Tripping Alarm Output OFF	
		Tripping Alarm Output (TRP)	Transistor output 30 VDC max. and 50 mA max., Leakage current: 0.1 mA max., Residual voltage: 2 V max.		
	Alarm functions	Overvoltage alarm	Setting range: 20.0 to 28.8 V (in 0.1-V units), Alarm Output (ALM) OFF		
		Undervoltage alarm	Setting range: 18.0 to 26.4 V (in 0.1-V units), Alarm Output (ALM) OFF		
		Overcurrent alarm	Setting range: 0.5 to 4.0 A (in 0.1-A units), Alarm Output (ALM) OFF	Setting range: 0.5 to 3.8 A (in 0.1-A units), Alarm Output (ALM) OFF	
		Run time alarm	Setting range: 0.0 to 99.9 kh (in 0.1-kh units), Alarm Output (ALM) OFF (The alarm output is disabled if the time is set to 0.0 kh.)		
		Alarm Output (ALM)	Transistor output 30 VDC max. and 50 mA max., Leakage current: 0.1 mA max., Residual voltage: 2 V max.		
	Over-temperature function	Over-temperature	Setting range: 25 to 80°C, Over-temperature Output		
		Over-temperature Output (TMP)	Transistor output 30 VDC max. and 50 mA max., Leakage current: 0.1 mA max., Residual voltage: 2 V max.		
	Display functions	Input voltage display/detection	Display range: 17.0 to 30.0 V Display accuracy: 2% rdg ±1 digit max.		
		Output current display/detection	Branch output display range: 0.0 to 10.0 A Peak output current display range: 0.0 to 10.0 A Total current display range: 0.0 to 40.0 A Display accuracy: 5% FS (4 A) ±1 digit max.		
		Run time	Display range: 0.0 to 99.9 kh Display accuracy: 2% rdg ±1 digit max.		
		Temperature display/detection	Display range: -10 to 100°C Display accuracy: 2°C ±1 digit max.		
	External Tripping Input (TRG)		19.2 to 30 VDC, minimum signal width: 20 ms, tripping after input within 10 ms + the shutdown sequence set time		
Startup sequence		A delay can be enabled/disabled for each branch output, setting range: 0.0 to 99.9 s in 0.1-s units.			
Shutdown sequence		A delay can be enabled/disabled for each branch output, setting range: 0.0 to 99.9 s in 0.1-s units.			
Communications		None	Supported (RS-232C)		
Sampling period		1 ms			

Item	Model	S8M-CP04	S8M-CP04-R	S8M-CP04-RS
Other	Ambient operating temperature	Refer to the derating curve (no condensation or icing allowed).		
	Storage temperature	-25 to 65°C		
	Ambient operating humidity	25% to 85% (storage: 25% to 90%)		
	Withstand voltage	1.0 kVAC for 1 min between all charged sections and all non-charged sections (detection current: 20 mA) 500 VAC for 1 min between all I/O and I/O signals/communications (detection current: 20 mA) 500 VAC for 1 min between all I/O signals and communications (detection current: 20 mA) 500 VAC for 1 min between input signals and all output signals (detection current: 20 mA)		
	Insulation resistance	100 MΩ min. at 500 VDC between all charged sections and all non-charged sections 100 MΩ min. at 500 VDC between all I/O and I/O signals/communications 100 MΩ min. at 500 VDC between all I/O signals and communications		
	Vibration resistance	No abnormality after 10 to 55 Hz at 0.375-mm single amplitude for 2 h each in 3 directions.		
	Shock resistance	No abnormality after 150 m/s ² 3 times each in 6 directions.		
	Conducted EMI	Conforms to EN 61204-3 Class B.		
	Radiated EMI	Conforms to EN 61204-3 Class B.		
	Safety standards	UL: UL 508 (Listing), UL 60950-1 cUL: CSA C22.2 No. 107-1 cUR: CSA No. 60950-1 EN/VDE: EN 50178 (= VDE0160) EN 60950-1 (= VDE0805 Teil 1)		UL: UL 508 (Listing, Class 2: Per UL 1310), UL60950-1 cUL: CSA C22.2 No. 107-1 cUR: CSA No. 60950-1 EN/VDE: EN 50178 (= VDE0160), EN 60950-1 (= VDE0805 Teil 1)
Weight	400 g max.			

External Output and External Tripping Input Specifications

The S8M has 3 external outputs, the Tripping Alarm Output (TRP), Alarm Output (ALM), and Over-temperature Output (TMP), as well as an External Tripping Input (TRG). Each of these I/O circuits is independent.

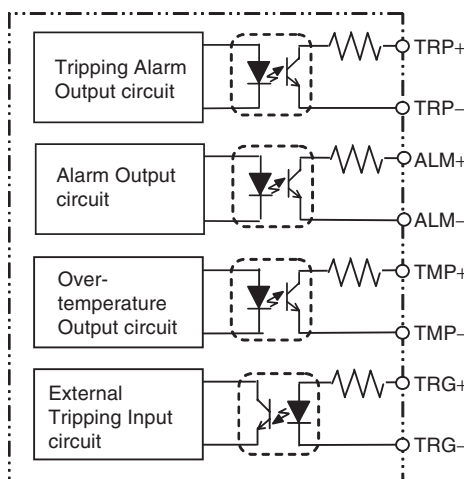

I/O Circuit Configuration

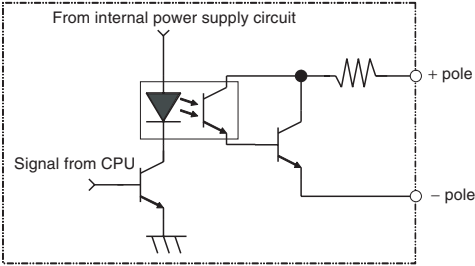
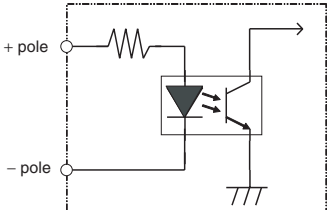
Name	Circuit configuration	I/O specifications
Tripping Alarm Output (TRP), Alarm Output (ALM), and Over-temperature Output (TMP)	<p>Output circuit</p> <p>Internal Circuit Configuration of the Alarm and Over-temperature Outputs</p> 	<p>30 VDC and 50 mA max. Transistor output</p>
External Tripping Input (TRG)	<p>Input circuit</p> <p>Internal Circuit Configuration of the External Tripping Input</p> 	<p>19.2 to 30.0 VDC Minimum signal width: 10 ms</p>

Note When a branch output is cut off with the External Tripping Input, it cuts off power to the branch output even faster than turning OFF the S8M's power supply.

Example Operation of the Alarm Output (ALM)

This example shows the ALM output operation when an undervoltage alarm occurs.

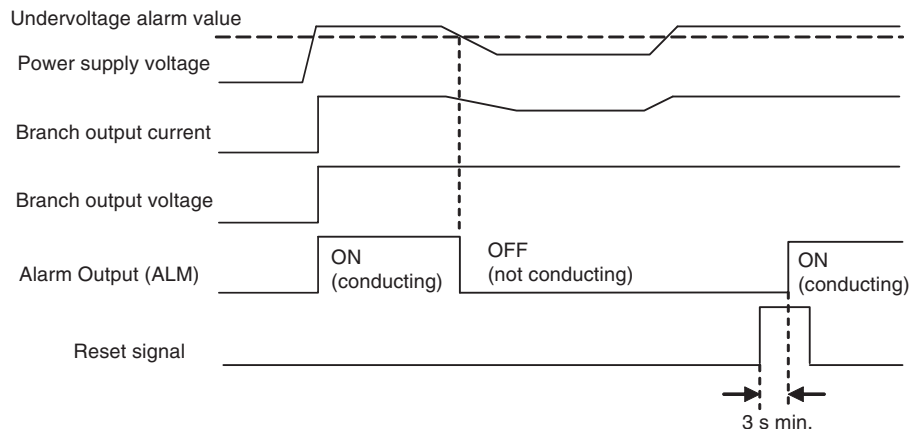

Example Operation of the Tripping Alarm Output (TRP)

This example shows the TRP output operation when an overcurrent alarm or abnormal current tripping occurs.

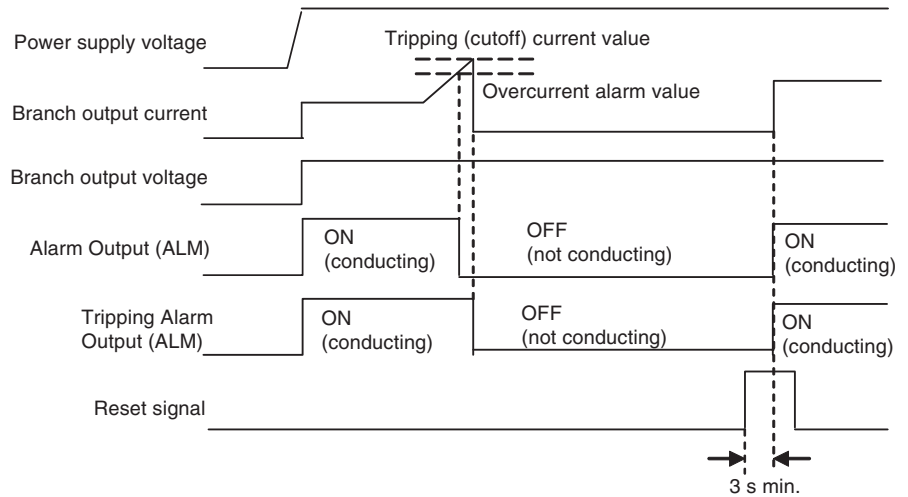

Example Operation of the Over-temperature Output (TMP)

The Over-temperature Output is reset automatically when the temperature falls to 3°C below the over-temperature output value.

For details, refer to page 28.

2-4 Basic Function Details

2-4-1 Current Protection Functions

Abnormal Current Tripping

A different current tripping value can be set for each branch output. Set the current tripping values between 0.5 and 4.0 A (in 0.1 A units) with the S8M-CP04 and S8M-CP04-R, or between 0.5 and 3.8 A (in 0.1 A units) with the S8M-CP04-RS.

The abnormal current tripping type can be set to standard detection (tripping within 100 ms) or instantaneous detection (tripping within 20 ms).

When the S8M detects an abnormal current, that branch output is cut off by its semiconductor relay. When the output is cut off, the error code (A11) and present current are displayed alternately on the seven-segment display and the Tripping Alarm Output (TRP) is turned OFF.

To reset the alarm, press the Reset Key 15 s after the alarm occurred.

Setting range	Default value	Tripping type	Operation	Error code and alarm output	Conditions required to reset
0.5 to 4.0 A (0.5 to 3.8 A in the S8M-CP04-RS)	4.0 A (3.8 A in the S8M-CP04-RS)	Standard	When a current higher than the set value is detected, the branch output is cut off within 100 ms.	The error code (A11) and current are displayed alternately on the seven-segment display and the Tripping Alarm Output (TRP) is turned OFF.	The Reset Key can be used to reset the alarm once 15 s have elapsed after the alarm.
		Instantaneous	When a current higher than the set value is detected, the branch output is cut off within 20 ms.		

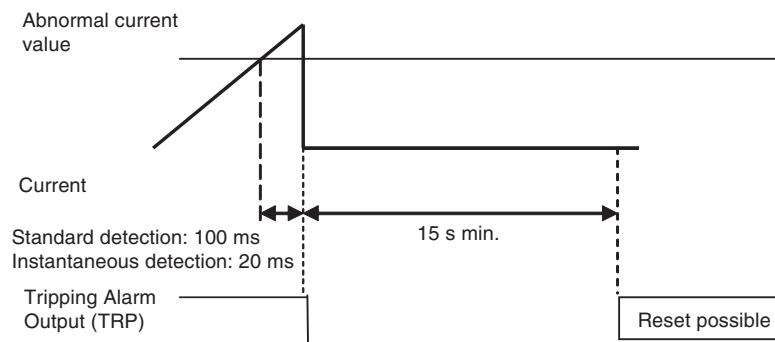

Note After sampling and converting each branch output's current every 1 ms, the S8M processes the values in the CPU and controls the branch output cutoffs. This method achieves high-speed, high-accuracy tripping. In addition, to minimize the effects of excessive currents caused by short-circuits, the S8M is equipped with built-in current-limiting circuits. Consequently, there is a region in which the current is limited, as shown in the current tripping characteristics graphs.

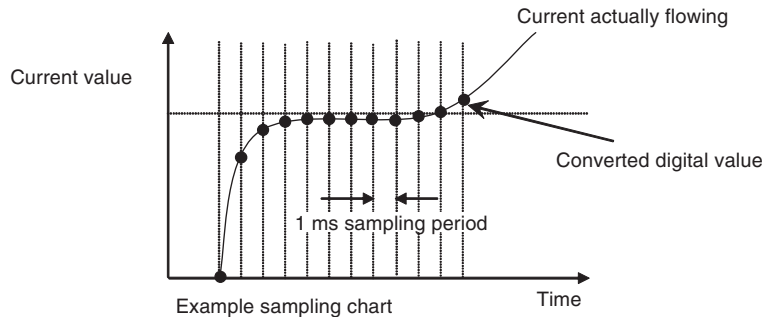

Current Tripping Characteristics

The current tripping characteristics vary slightly in different S8M models.

■ **S8M-CP04-R and S8M-CP04 (Model without RS-232C Port)**

Current Tripping Characteristics When Standard Detection Is Selected

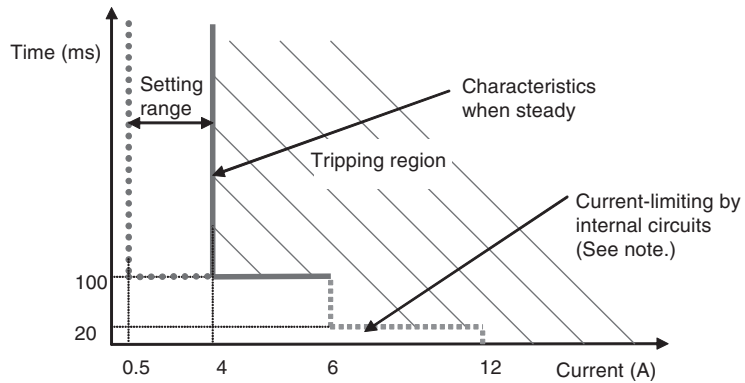

Current Tripping Characteristics When Instantaneous Detection Is Selected

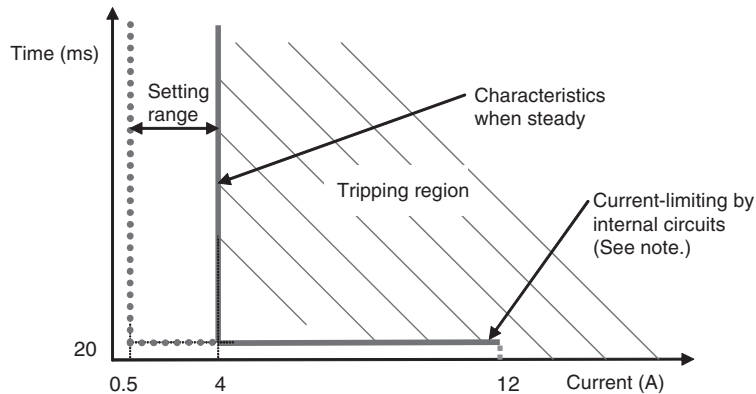

Note The S8M contains a current-restricting circuit that prevents a current above a specific value from flowing. The current is thus restricted during the time required to cut off the output.

■ **S8M-CP04-RS (UL Class 2 Output Model)**

In addition to the regular current tripping function that cuts off operation at the user-set tripping current, the Class 2 output model is equipped with a tripping circuit that cuts off operation if the branch output's current exceeds 4.0 A (fixed).

Current Tripping Characteristics When Standard Detection Is Selected

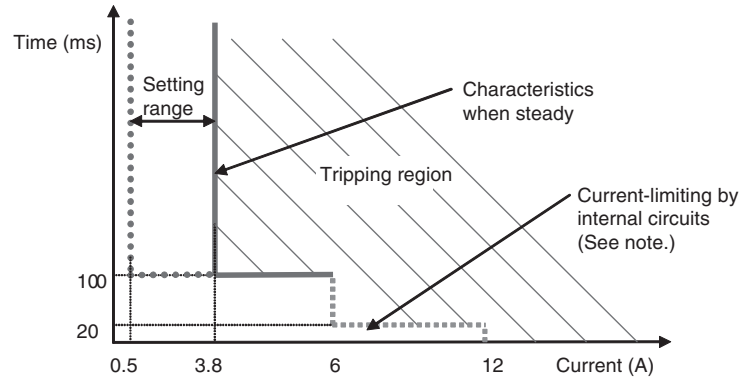

Current Tripping Characteristics When Instantaneous Detection Is Selected

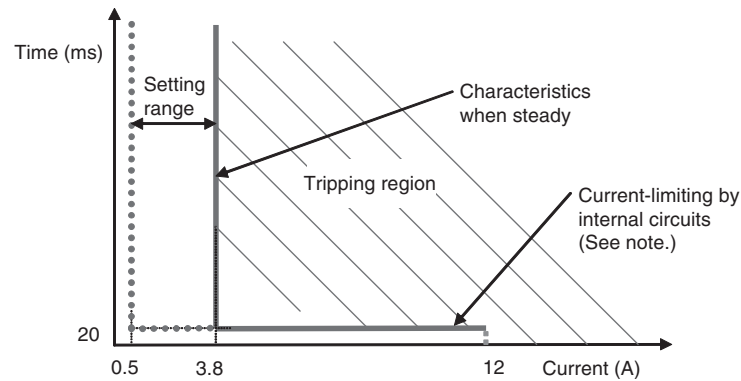

Note The S8M contains a current-restricting circuit that prevents a current above a specific value from flowing. The current is thus restricted during the time required to cut off the output.

Startup Delay

Normally, a large inrush current may run through the system when equipment starts. Tripping operation can be disabled for a short time after the semiconductor relay goes ON in order to prevent this inrush current from being detected as an abnormal current and cutting off operation. This temporary disabling of the tripping function is called the startup delay.

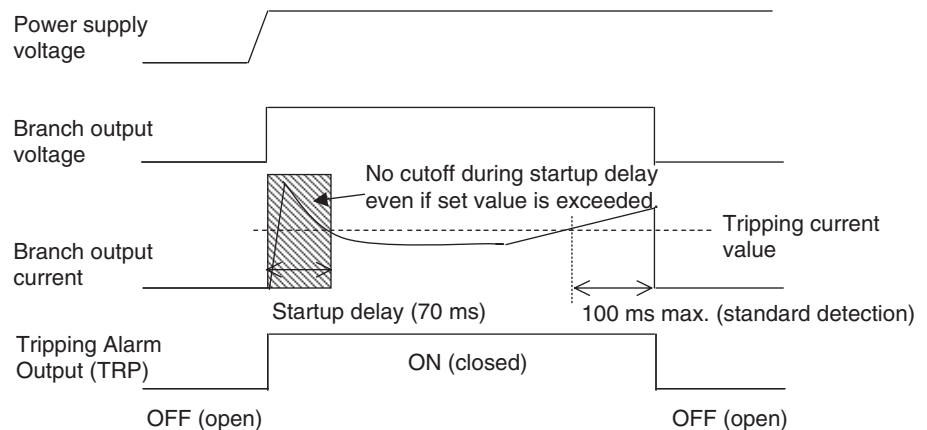

Note The startup delay disables the tripping operation for the specified period of time. The inrush current during this time can be displayed as the peak output current. The S8M, however, contains a current-restricting circuit, so the peak

value is not necessarily an accurate measure of the peak inrush current of the connected device.

Overcurrent Alarm Function

Each branch output's current tripping value can be set between 0.5 and 4.0 A (0.5 to 3.8 A in the S8M-CP04-RS) in 0.1 A units. In addition, the overcurrent alarm type can be set to standard detection or instantaneous detection.

Setting range	Default value	Alarm type	Operation	Error code and alarm output	Conditions required to reset
0.5 to 4.0 A (0.5 to 3.8 A in the S8M-CP04-RS)	4.0 A (3.8 A in the S8M-CP04-RS)	Standard	When the current is higher than the set value continuously for 80 ms or more, the alarm is output within 100 ms.	The error code (A22) and current are displayed alternately on the seven-segment display and the Alarm Output (ALM) is turned OFF.	The Reset Key can be used to reset the alarm once the current is 0.3 A or more below the set value.
		Instantaneous	When the current is higher than the set value continuously for 10 ms or more, the alarm is output within 20 ms.		

■ Operation

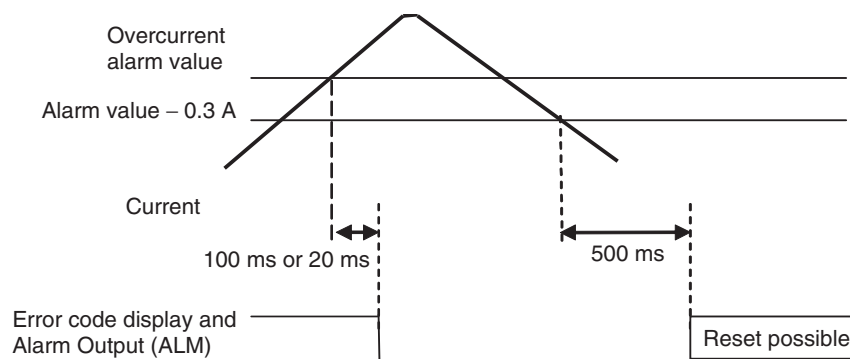

- The Alarm Output (ALM) will be turned OFF if the branch output's current exceeds the alarm value continuously for 80 ms or more (standard detection) or 10 ms (instantaneous detection).
- In this case, the seven-segment display will alternately display the error code (A22) and present current.
- The error display and Alarm Output can be cleared when the current has been below the alarm value continuously for 500 ms or more.

Alarm and Tripping Operation When Overcurrent/Abnormal Current Occurs

The following example shows the alarm and tripping operation when the overcurrent alarm value < abnormal current tripping value. It is also possible to set the overcurrent alarm value > abnormal current tripping value.

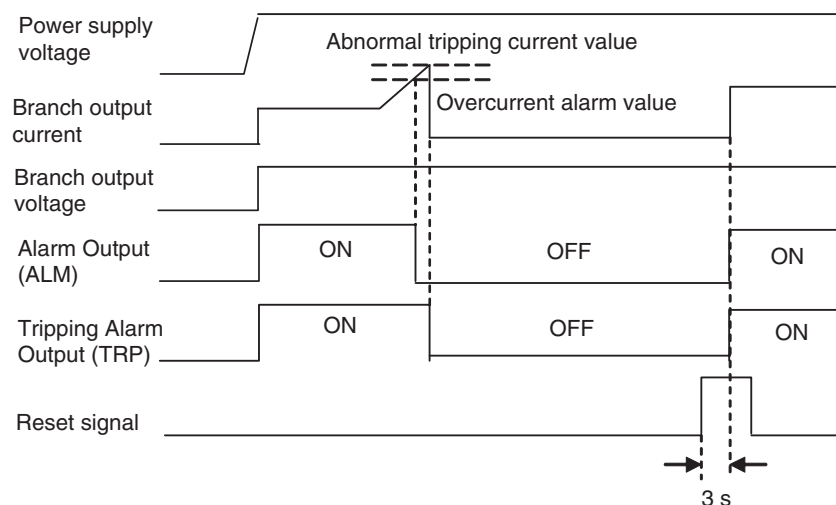

Safety Functions

Short-circuit Protection Fuse

If an error occurs that prevents the semiconductor relay from cutting off a branch output's current, the short-circuit protection fuse will blow to protect the circuit.

Note If the fuse blows, that branch output cannot be used.

Thermal Fuse

If an error occurs that prevents the semiconductor relay from cutting off a branch output and the temperature of the S8M's internal resistors rises abnormally high, the S8M's thermal fuse will blow to prevent a fire hazard.

Note If the fuse blows, that circuit cannot be used.

Safety When Cycling Power from Test Mode

If the S8M is turned OFF in Test Mode, all branch outputs will be disconnected when the power is turned ON again. This is because the connection/disconnection settings have not been completed, so all outputs are disconnected to ensure safety. After completing connection/disconnection settings in Test Mode, always change to Run Mode or Setting Mode before turning OFF the power supply.

2-4-2 Overvoltage/Undervoltage Protection Function

Abnormal Voltage Tripping

When the input power supply voltage exceeds 28.8 V (see note), all of the branch outputs will be cut off and the seven-segment display will indicate error code A10. It is not necessary for the user to set any parameters for this function.

Tripping operation	Seven-segment display	Outputs	Conditions required to reset
28.8 V min. 20 ms max.	Alternately displays error code A10 and the voltage.	The Tripping Alarm Output (TRP) is turned OFF.	Voltage below 28.5 V and 15 s elapsed after output is cut off.

Note The voltage is measured at the power input terminals.

Overvoltage Alarm

An overvoltage alarm value can be set between 20.0 and 28.8 V.

Setting range	Default value	Operation	Seven-segment display	Outputs	Conditions required to reset
20.0 to 28.8 V	28.8 V	When the voltage is higher than the alarm value continuously for 80 ms or more, the alarm is output within 100 ms.	Alternately displays error code A20 and the voltage.	The Alarm Output (ALM) is turned OFF.	Voltage below the alarm value -0.3 V continuously for at least 500 ms.

■ Operation

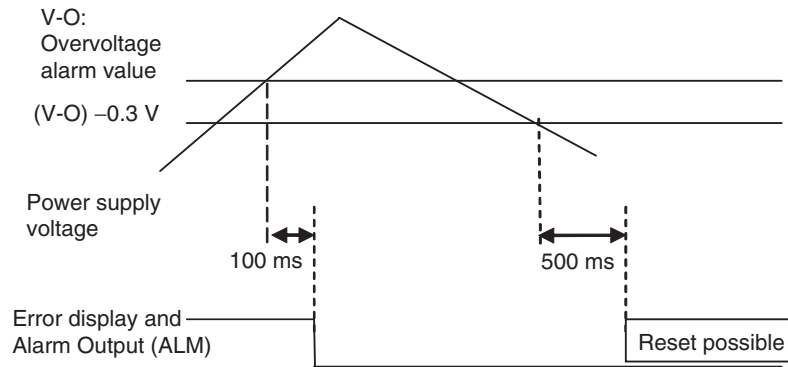

- When a voltage exceeding the alarm value is applied, the seven-segment display will show error code A20 and the Alarm Output (ALM) will go OFF within 100 ms.
- The error display and Alarm Output can be reset when the voltage has been below the alarm value -0.3 V for 500 ms or more.

Undervoltage Alarm

An overvoltage alarm value can be set between 18.0 and 26.4 V.

Setting range	Default value	Operation	Seven-segment display	Outputs	Conditions required to reset
18.0 to 26.4 V	20.0 V	When the voltage is lower than the alarm value continuously for 80 ms or more, the alarm is output within 100 ms.	Alternately displays error code A21 and the voltage.	The Alarm Output (ALM) is turned OFF.	Voltage above the alarm value $+0.3$ V continuously for at least 500 ms.

■ Operation

- When a voltage below the alarm value is applied, the seven-segment display will show error code A21 and the Alarm Output (ALM) will go OFF within 100 ms.
- The error display and Alarm Output can be reset when the voltage has been above the alarm value $+0.3$ V for 500 ms or more.

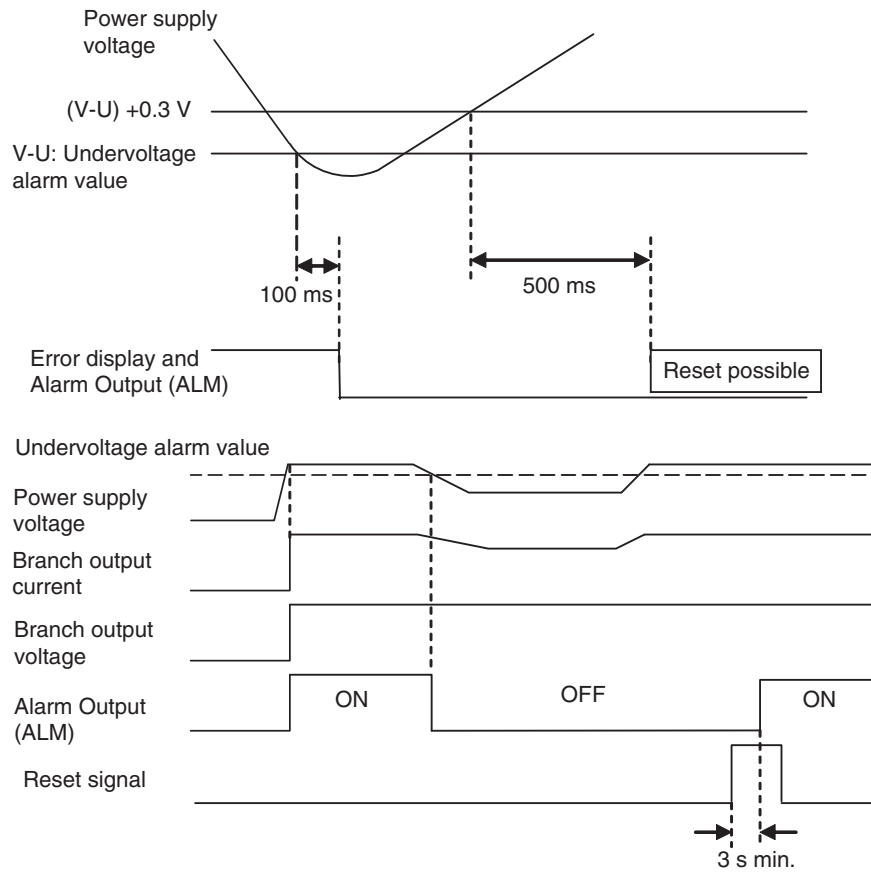

2-4-3 Over-temperature Output

When the temperature exceeds the set value continuously for more than 1 s, the seven-segment display will show error code A30 and the Over-temperature Output (TMP) will go OFF.

The error display and Over-temperature Output are reset automatically when the temperature has been below the set value $- 3^{\circ}\text{C}$ for more than 5 s.

Setting range	Default value	Operation	Seven-segment display	Outputs	Conditions required to reset
25 to 80°C	80°C	The output is turned OFF when the temperature is higher than the set value continuously for more than 1 s.	Alternately displays error code A30 and the temperature ($^{\circ}\text{C}$).	The Over-temperature Output (TMP) is turned OFF.	Reset automatically when the temperature falls below the set value $- 3^{\circ}\text{C}$.

■ Operation

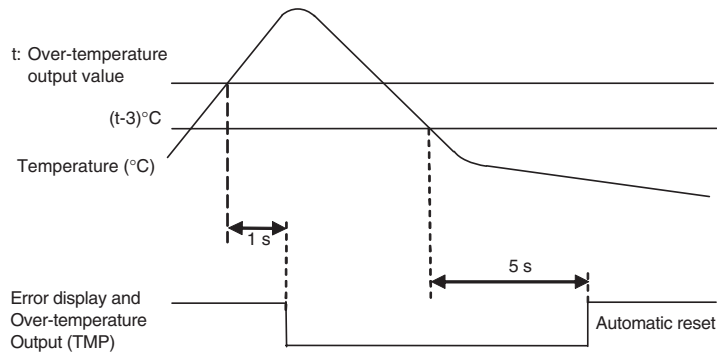

The Over-temperature Output (TMP) operates independently of the other external outputs. This output can be used to start an exhaust fan or air conditioner to reduce the temperature in the control panel.

Example Application

The output is normally closed (ON) and goes OFF when there is an error, so receive the TMP output through an auxiliary relay. In addition, the output will go ON momentarily when the power is turned ON, so receive the output through a time-delay relay. (For details, refer to page 41.)

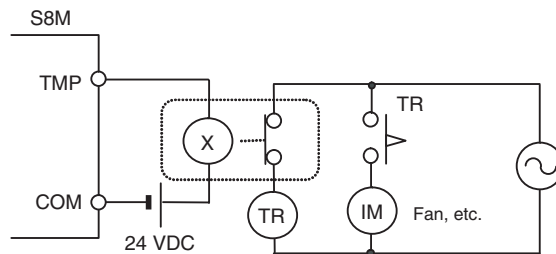

Relationship between Control Panel Temperature and S8M's Internal Temperature

The internal temperature of the S8M is displayed. This is not necessarily the same as the ambient temperature of the S8M or the temperature inside the control panel. The difference between the internal temperature of the S8M and the ambient temperature depends on the current flowing through the S8M. Consider this difference in the application. The following graph provides reference information on the displayed internal temperature and the ambient temperature.

Conditions: The same current was output from all branch outputs in a constant-temperature bath held at a constant temperature.

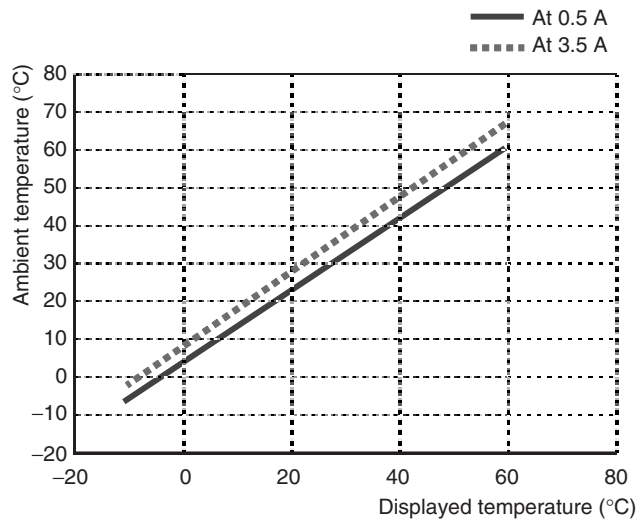

2-4-4 Run Time Alarm

An alarm can be output when the run time exceeds the alarm value.

Setting range	Default value	Operation	Seven-segment display	Outputs	Conditions required to reset
0.0 to 99.9 kh	0.0 kh (See note.)	An alarm is output when the run time exceeds the alarm value.	Alternately displays error code A23 and the run time.	The Alarm Output (ALM) is turned OFF.	Either set a higher alarm value or clear the run time.

Note An alarm will not be output when the alarm value is set to 0.0 kh. Set the alarm value to 0.0 kh (default value) when the run time alarm is not needed.

Refer to page 71 for details on clearing the run time.

2-5 Startup Sequence Function

The inrush current may cause a voltage drop if all of the branch outputs are connected simultaneously and there is little spare capacity in the power supply or the loads connected to the branch outputs are capacitive loads. A significant voltage drop may cause an output to be cut off. In this case, a time delay (see note) can be applied between the connections of the branch outputs to minimize the voltage drop.

- Note**
- (1) The time delay can be set between 0.0 and 99.9 s. (If the delay is set to 0.0 s, the startup sequence will not operate and the branch output will be connected immediately.)
 - (2) The startup sequence is designed for the four branch outputs on one S8M. It does not provide time synchronization between outputs on more than one S8M.

After the power supply is turned ON and the self-diagnostics are performed, the S8M will start connecting the branch output according to their preset startup sequence times.

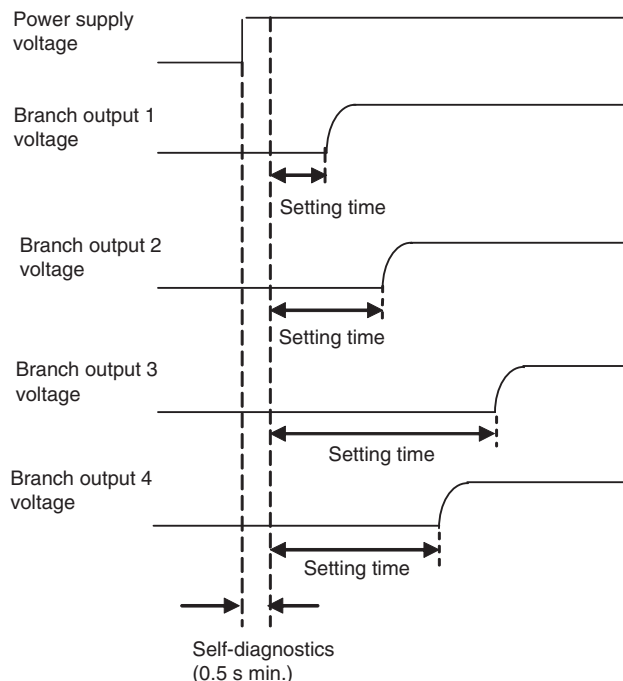

- The branch output's status indicator will flash green during the startup sequence time until it is connected.
- The startup sequence's operation can be verified in Test Mode. For details, refer to 5-3 *Checking Sequence Operation*.
- The startup sequence's operation can also be verified from the Support Tool by clicking the **Startup Sequence** Button. (For details, refer to page 94.)

Note The startup sequence functions in the following processes:

- Connecting when power is turned ON
- Reconnecting during a reset operation
- Startup sequence executed by CompoWay/F command (Startup Sequence)
- Simultaneous connection of all outputs in Test Mode
- Startup sequence executed from the Support Tool

2-6 Shutdown Sequence Function

When the S8M's input power supply is turned OFF, all of the branch outputs are turned OFF (disconnected) simultaneously. On the other hand, when the branch outputs are cut off by the external tripping input or communications, a time delay (see note 1) can be applied between the branch output disconnections.

- Note**
- (1) The time delay can be set between 0.0 and 99.9 s. (If the delay is set to 0.0 s, the startup sequence will not operate and the branch output will be cut off immediately.)
 - (2) The shutdown sequence is designed for the four branch outputs on one S8M. It does not provide time synchronization between outputs on more than one S8M.

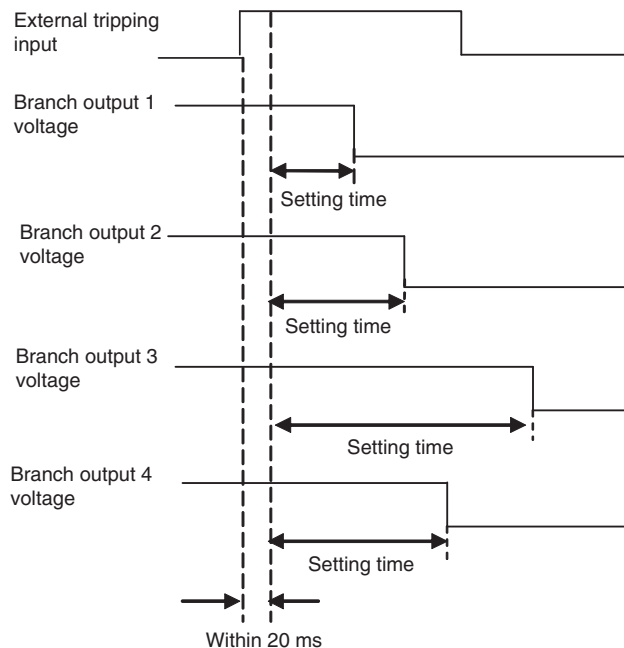

Note

- (a) When operation is cut off due to an abnormal voltage (above 28.8 V), all of the branch outputs will be cut off simultaneously.
- (b) The shutdown sequence function will operate on a branch output only if the external tripping input is enabled for that branch output.
- The shutdown sequence's operation can be verified in Test Mode. For details, refer to *5-3 Checking Sequence Operation*.
- The shutdown sequence's operation can also be verified from the Support Tool by clicking the **Shutdown sequence** Button on the Present Values Window. (For details, refer to page 94.)

Note The shutdown sequence functions in the following processes:

- Operation cut off by the external tripping input
- Shutdown sequence executed by CompoWay/F command (Startup Sequence)
- Simultaneous cutoff of all outputs in Test Mode
- Shutdown sequence executed from the Support Tool

SECTION 3

Installation and Wiring

This section describes how to install and wire the S8M.

3-1	Installation Environment.....	34
3-2	Installation.....	35
3-3	Wiring.....	39
3-4	RS-232C Port Wiring (S8M-CP04-R and S8M-CP04-RS Only).....	43

3-1 Installation Environment

Installation and Wiring Precautions

To increase the S8M system's reliability and take full advantage of the S8M's functions, observe the following precautions when installing the S8M.

Installation Site

Avoid locations with any of the following conditions when installing the S8M.

- Locations subject to a temperature below -10°C or over 60°C
- Locations subject to a humidity below 25% or over 90% (no condensation/icing)
- Locations subject to direct sunlight
- Locations subject to exposure to liquids, debris, or corrosive gases
- Locations subject to severe shock or vibration
- Locations near equipment that generates strong high-frequency noise or surges

Always enclose or protect the S8M sufficiently in the following locations.

- Locations subject to static electricity or other forms of noise.
- Locations subject to strong electromagnetic fields.
- Locations subject to possible exposure to radioactivity.
- Locations close to power lines.

Installation in Cabinets or Control Panels

When the S8M is being installed in a cabinet or control panel, always provide suitable ambient conditions as well as access for operation and maintenance.

Ambient Temperature

The operating temperature range for the S8M is -10°C to 60°C . Observe the following precautions.

- Provide enough space for good air flow.
- Do not install the S8M above equipment that generates a large amount of heat, such as heaters, transformers, or high-capacity resistors.
- If the ambient temperature in the cabinet may exceed 60°C , install an exhaust fan or air conditioner and use the Over-temperature Output to operate the cooling equipment.

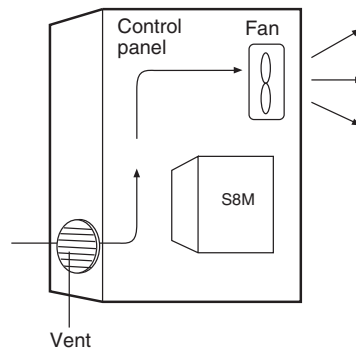

- Mount the S8M at least 20 mm away from heat sources.
- The S8M can be installed side-by-side.

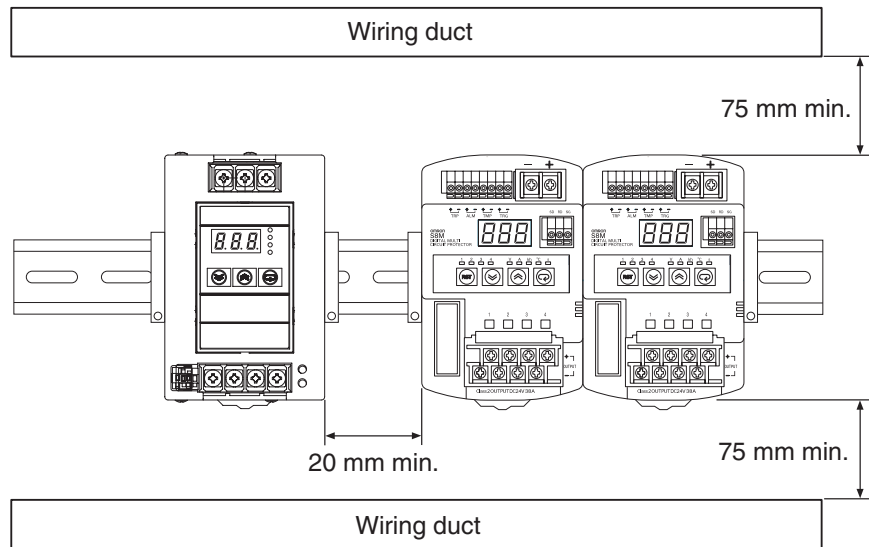

3-2 Installation

When mounting the S8M in a panel, use DIN Rail. Surface installation cannot be used.

Mounting in a Panel

- The S8M must be installed in the orientation shown below to ensure adequate cooling.

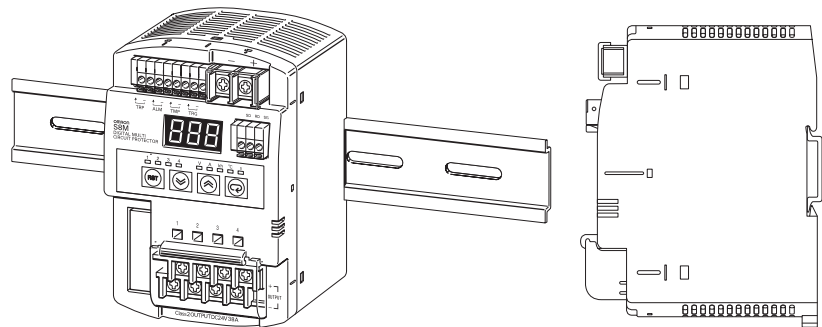

- Do not install the S8M in any of the following orientations.

Incorrect

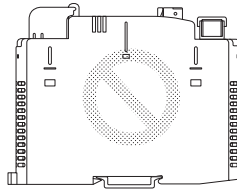

Incorrect

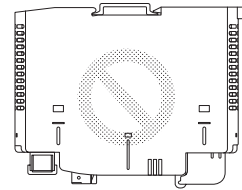

Incorrect

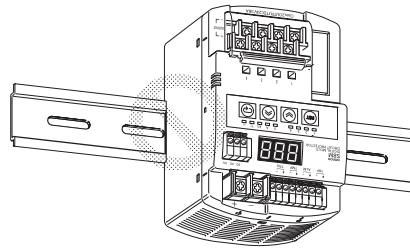

Incorrect

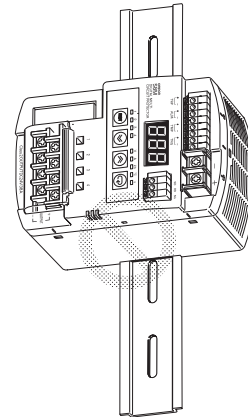

External Dimensions

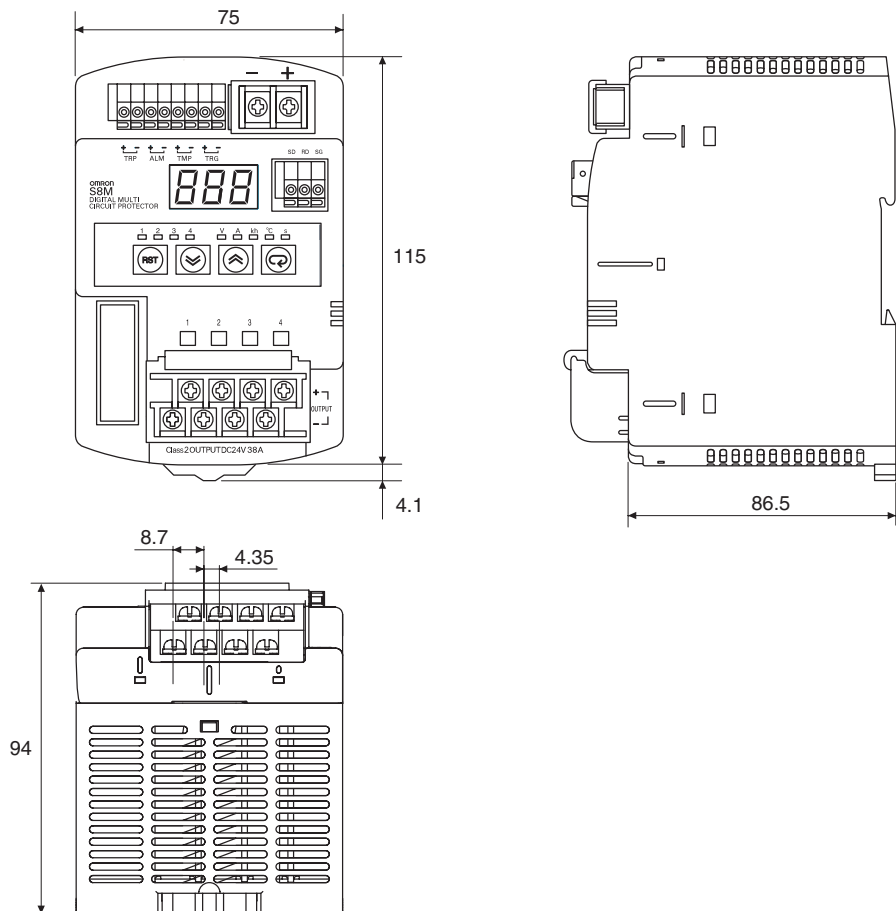

DIN Rail Installation

Always install the S8M on DIN Rail.

■ **Recommended DIN Rail**

PFP-50N (50 cm), PFP-100N (100 cm), or PFP-100N2 (100 cm)

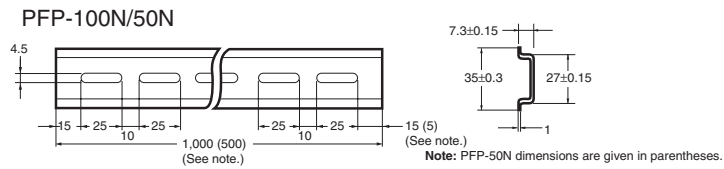
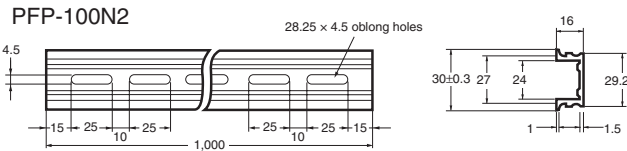
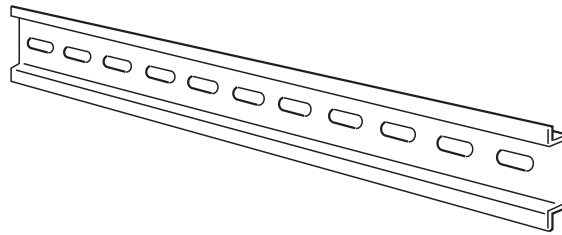

Mount the DIN Rail with M4 screws in at least three places, with a maximum separation of 210 mm (6 holes) between screws. The tightening torque is 1.2 N·m (10.8 in·lb).

Attachment to the DIN Rail

The S8M attaches to the DIN Rail with one snap. Hang the S8M on the top of the DIN Rail with the installation notch on the back of the S8M, pivot the S8M downward, and press until the S8M locks securely on the Rail.

1,2,3...

1. Lower the S8M so that the installation notch hooks onto the top of the DIN Rail.

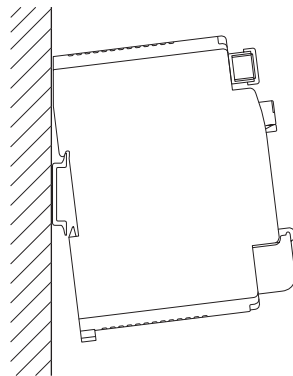

2. Press the S8M firmly onto the DIN Rail to mount it. Press until the locks engage securely. Press firmly, but carefully, to avoid damaging the S8M.

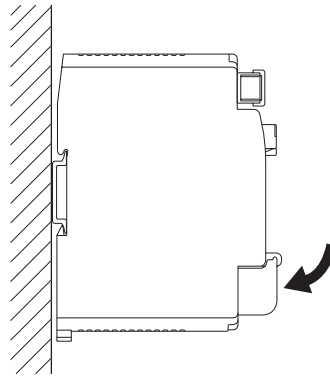

Attach an End Plate on each side of the S8M to fix it in place.

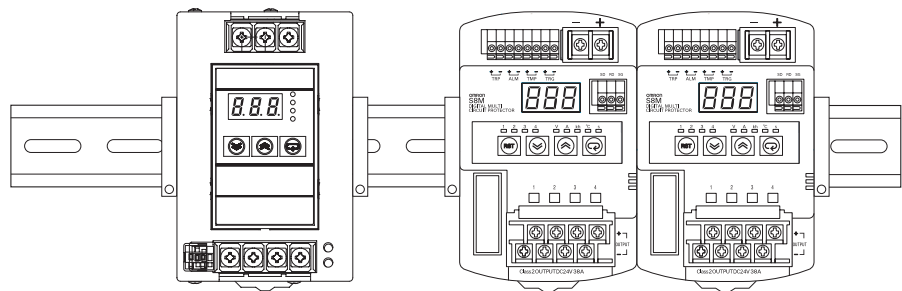

■ Recommended End Plate

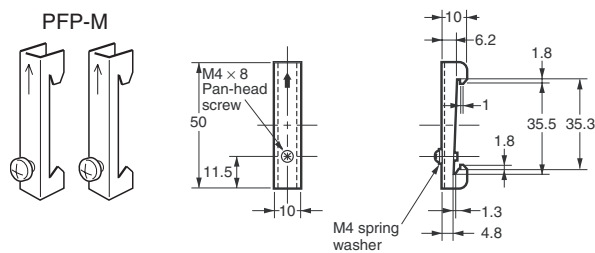

Removal

When removing the S8M from the DIN Rail, pull the lock lever down with a flat-blade screwdriver and pivot the S8M upward to remove it.

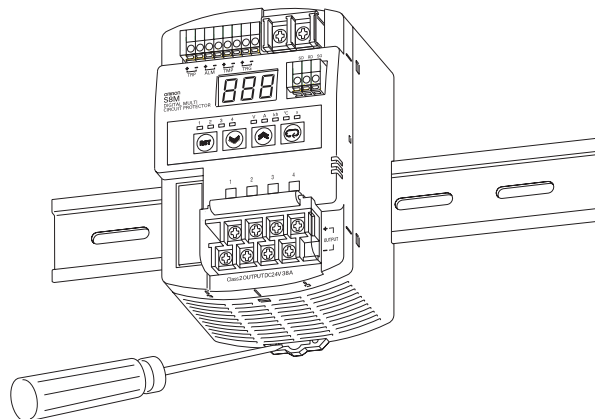

3-3 Wiring

Wiring Precautions

- When wiring, cover the top of the S8M to prevent wire strands from entering. After completing the wiring, be sure to remove the cover to avoid overheating.
- The power input terminals have M4 screws. Use the following crimp terminals on the power input wires and tighten the terminal screws to a torque of 1.08 N·m (9.6 in·lb).

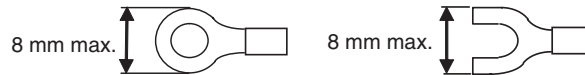

- The branch output terminals have M3.5 screws. Use the following crimp terminals on the branch output wires and tighten the terminal screws to a torque of 0.8 to 1.0 N·m (7.2 to 8.8 in·lb).



Recommended Power Supply Units

The following OMRON Power Supply Units are recommended as the DC power supply for the S8M.

Series	Model	Output	
		Capacity	24-VDC output current
S8VS	S8VS-06024□□	60 W	2.5 A
	S8VS-09024□□	90 W	3.75 A
	S8VS-12024□□	120 W	5 A
	S8VS-18024□□	180 W	7.5 A
	S8VS-24024□□	240 W	10 A
S8VM	S8VM-05024□□	50 W	2.2 A
	S8VM-10024□□	100 W	4.5 A
	S8VM-15024□□	150 W	6.5 A
	S8VM-30024C	300 W	14.0 A
	S8VM-60024C	600 W	27.0 A

Selecting the Wire

Refer to the following table when selecting wire to use for the power supply.

AWG	Cross-sectional area (mm ²)	Configuration (wires/mm)	Voltage drop per A (mV/m)	Max. recommended current (A)	
				UL1007 (300 V 80°C)	UL1015 (600 V 105°C)
30	0.051	7/0.102	358	0.12	---
28	0.081	7/0.127	222	0.15	0.2
26	0.129	7/0.16	140	0.35	0.5
24	0.205	11/0.16	88.9	0.7	1.0
22	0.326	17/0.16	57.5	1.4	2.0
20	0.517	26/0.16	37.6	2.8	4.0
18	0.823	43/0.16	22.8	4.2	6.0
16	1.309	54/0.18	14.9	5.6	8.0
14	2.081	41/0.26	9.5	---	12.0
12	3.309	65/0.26	6.0	---	22.0
10	5.262	104/0.26	3.8	---	35.0

Maximum Recommended Current:

The values listed in the table above are for bundles of up to 4 wires. If 5 or more wires are bundled together, reduce the max. current to 80% of the listed current.

The following chart shows only the relationship between the voltage drop per meter and the current and wire length. Be sure that the current actually being used does not exceed the max. recommended current.

**Voltage Drop per Meter
(UL1015 Heat-resistant
PVC Wire)**

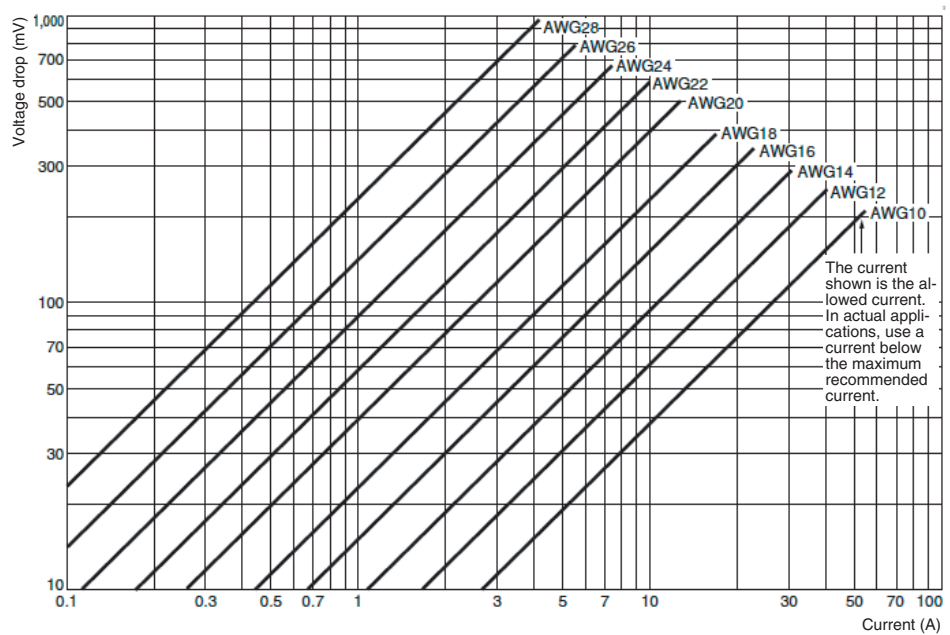

**Wiring the Power
Supply and Branch
Outputs**

Use a DC power supply with sufficient capacity and little voltage fluctuation, i.e., 24 VDC +10/-20%.

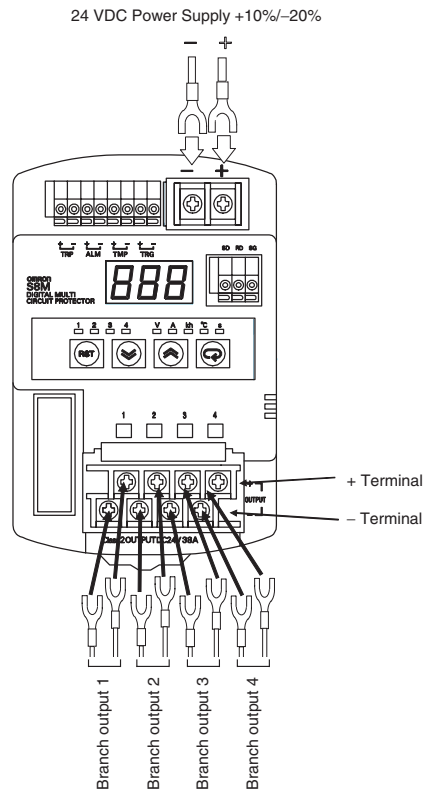

Wiring the External Outputs and External Tripping Input

The TRP, ALM, and TMP outputs operate as normally closed outputs, which are OFF when the power is OFF, ON during normal operation, and OFF when an error has occurred. If you want to use these external outputs as normally open outputs, invert the signals through auxiliary relays.

The branch output is cut off when the External Tripping Input (TRG) is ON (connected).

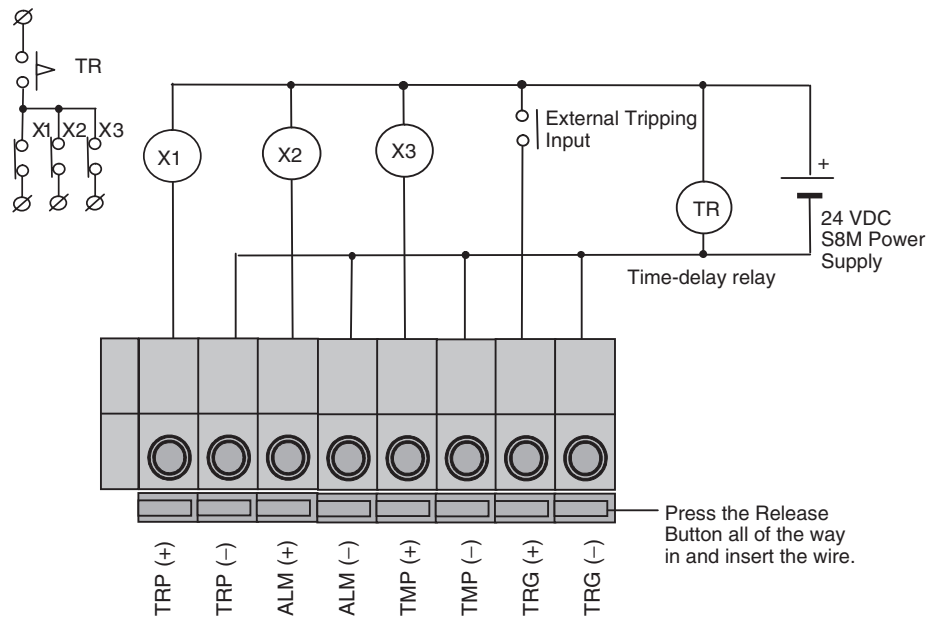

No.	Name	Function
1	TRP (+)	Tripping Alarm Output Output (internal transistor OFF) when the branch output is cut off due to an abnormal voltage or abnormal current.
2	TRP (-)	
3	ALM (+)	Alarm Output Turned OFF when the input voltage, current, or run time exceeded the corresponding set value.
4	ALM (-)	
5	TMP (+)	Over-temperature Output Turned OFF when the S8M's internal temperature exceeded the over-temperature output value.
6	TMP (-)	
7	TRG (+)	External Tripping Input Branch outputs can be cut off from an external operation. (The shutdown sequence is applied in this case.)
8	TRG (-)	

- Note**
- (1) Strip 10 mm from the ends of the I/O signal wires.
 - (2) Press the terminal's release button all the way in and insert the wire into the round wire hole.
 - (3) When the wire is inserted, be sure that the wire conductor is not exposed.
 - (4) Release the release button to lock the wire in place.
 - (5) After wiring, verify that the wires are securely locked in the terminals.

Internal Circuits

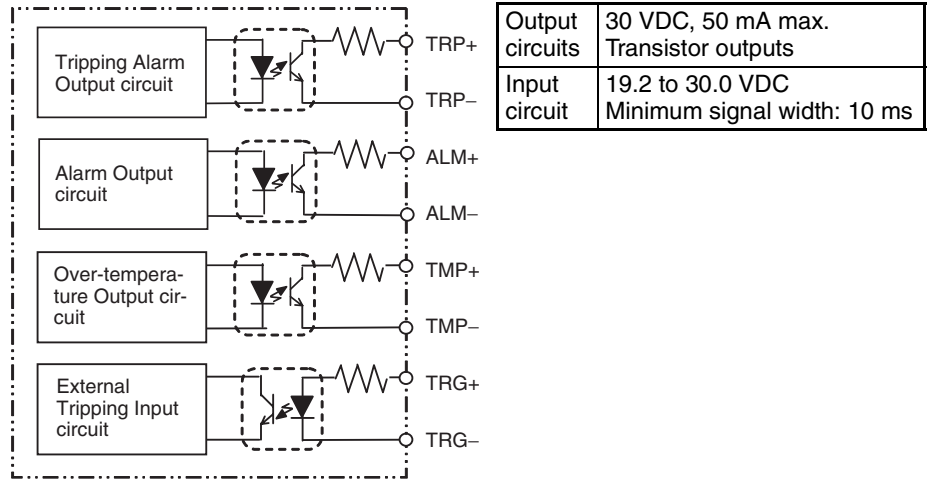

Note The three alarm output circuits are configured as independent circuits, so they can be used for either sinking or sourcing applications.

3-4 RS-232C Port Wiring (S8M-CP04-R and S8M-CP04-RS Only)

The S8M-CP04-R and S8M-CP04-RS have RS-232C port terminals for communications with the Support Tool.

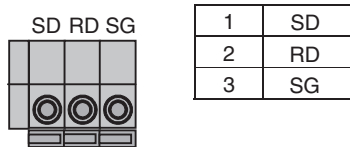

Creating the Connecting Cable

There is not an accessory connecting cable available to connect the S8M with personal computer. Assemble an RS-232C connecting cable as shown below.

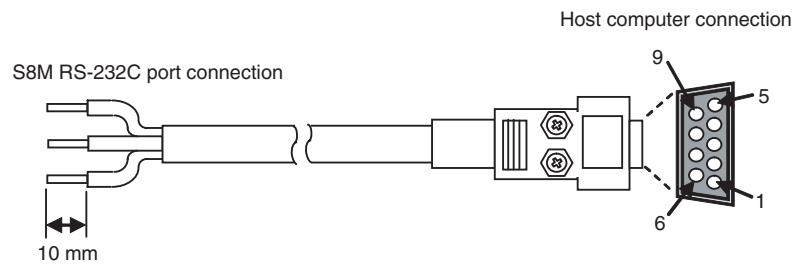

Pin	Signal abbreviation	Signal name
2	SD	Send data
3	RD	Receive data
5	SG	Signal ground

Wiring the RS-232C Port Terminals

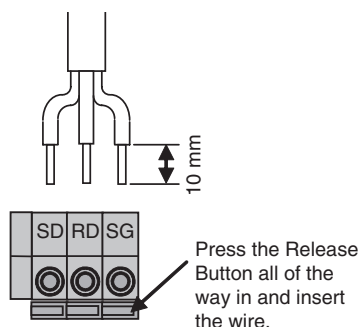

- Strip 10 mm from the ends of the RS-232C cable's wires.
- Press the terminal's release button all the way in and insert the wire into the round wire hole. When the wire is inserted, be sure that the wire conductor is not exposed.
- Release the release button to lock the wire in place.
- After wiring, verify that the wires are securely locked in the terminals.

Example Connection to a Host Computer

Example 1:1 Connection Using the RS-232C Port

■ **Connection to a Windows Computer**

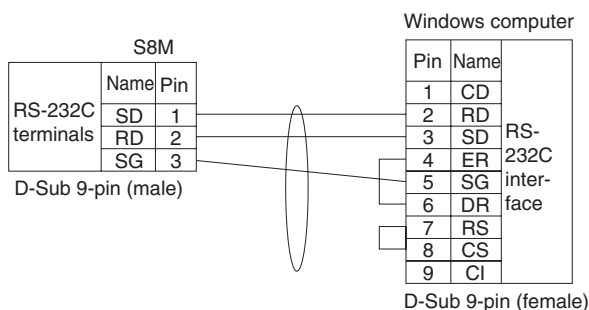

Example 1:1 Connection Using K3SC Serial Adapters

The K3SC Serial Adapters are required when the distance is over 15 m.

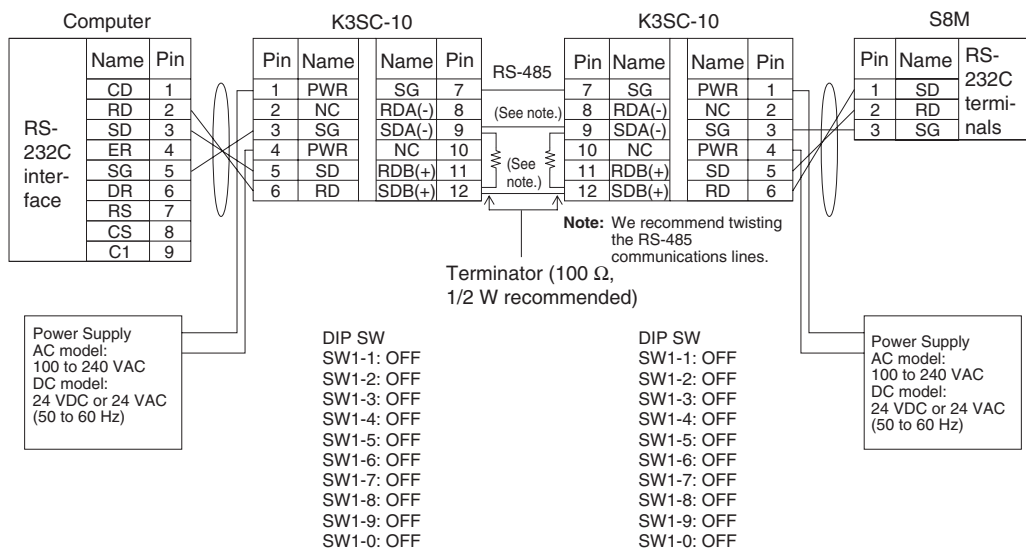

Example 1:N Connection Using K3SC Serial Adapters

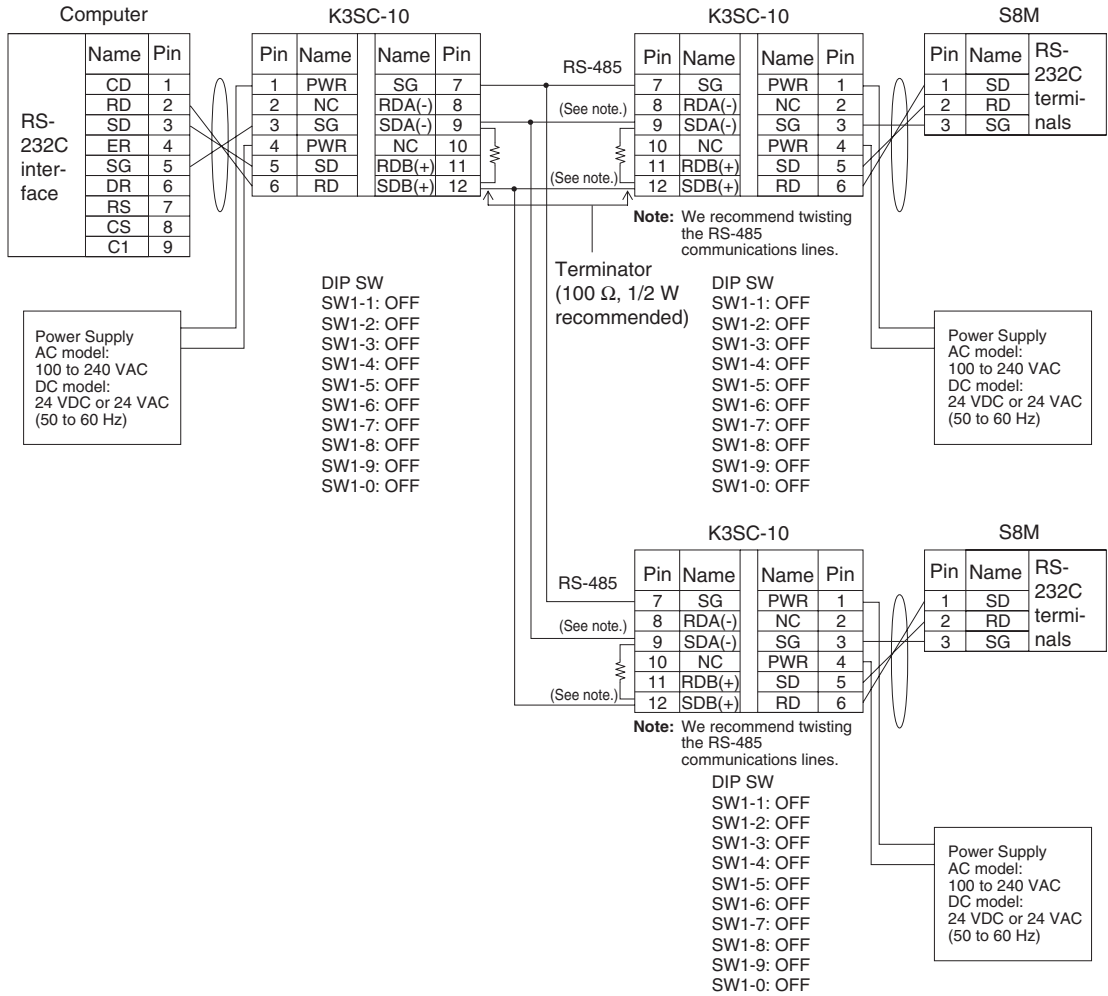

Note When connecting and communicating with multiple S8Ms in this way, a unique unit number must be set on each S8M. (For details on setting the unit number, refer to pages 67 and 87.)

SECTION 4

Parameter Settings

This section explains how to set S8M parameters.

4-1	Parameter Table	48
4-2	Parameter Setting Ranges	49
4-3	Switching the Operating Mode	49
4-4	Changing the Protection Level	54
4-5	Switching to Setting Mode	55
4-6	Individual Branch Output Settings	56
4-7	Shared Parameter Settings	60
4-8	Special Settings and Communications Settings	64

4-1 Parameter Table

The S8M's operation is determined by the parameter settings. Each parameter is set to its default value, but each parameter should be checked and set as required to adjust the S8M for use in the system.

When setting the parameters with the S8M's keys, switch the operating mode to Setting Mode.

The following table shows the setting parameters in the order that they are displayed in Setting Mode.

Parameter		Seven-segment display		Access in each protection level			Access from Support Tool
				2	1	0	
Branch output 1	Current tripping value	[-u	Set value	Δ	○	○	○
	Current tripping type	[-t	USU/LnS	×	×	○	○
	Overcurrent alarm value	R-u	Set value	Δ	○	○	○
	Overcurrent alarm type	R-t	USU/LnS	×	×	○	○
Branch output 2	Same as branch output 1						
Branch output 3							
Branch output 4							
Undervoltage alarm value		u-U	Set value	Δ	○	○	○
Overvoltage alarm value		u-ō	Set value	Δ	○	○	○
Run time value		tLn	Set value	Δ	○	○	○
Over-temperature output value		tP	Set value	Δ	○	○	○
Startup sequence	Branch output 1	UPS	Set value	×	×	○	○
	Branch output 2	UPS	Set value	×	×	○	○
	Branch output 3	UPS	Set value	×	×	○	○
	Branch output 4	UPS	Set value	×	×	○	○
Shutdown sequence	Branch output 1	dYS	Set value	×	×	○	○
	Branch output 2	dYS	Set value	×	×	○	○
	Branch output 3	dYS	Set value	×	×	○	○
	Branch output 4	dYS	Set value	×	×	○	○
External Tripping Input	Branch output 1	t-rG	ōFF/ōn	×	×	○	○
	Branch output 2	t-rG	ōFF/ōn	×	×	○	○
	Branch output 3	t-rG	ōFF/ōn	×	×	○	○
	Branch output 4	t-rG	ōFF/ōn	×	×	○	○
Unit number (communications setting)		Unō	Set value	×	×	○	○
Baud rate (communications setting)		dPS	48/96	×	×	○	○
Data length (communications setting)		LEn	7/8	×	×	○	○
Stop bits (communications setting)		bLē	1/2	×	×	○	○
Parity (communications setting)		PtY	nōn/Even/ōdd	×	×	○	○
Send wait time (communications setting)		Syt	Set value	×	×	○	○
Clear run time		LTr	YES/nō	×	○	○	○

×: No access (The parameter cannot be set or displayed.)

Δ: Read-only access

○: Full access (The parameter can be set or displayed.)

Note For details on the protection levels, refer to page 54.

4-2 Parameter Setting Ranges

Parameter	LED Indicators			Setting range	Default value	
	Seven-segment display	Branch output indicator	Unit indicator			
Current tripping value	[-u]	Only relevant circuits lit	A	0.5 to 4.0 A (See note 1.)	4.0 A (See note 1.)	
Abnormal current tripping type	[-t]			Standard or instantaneous	Standard	
Overcurrent alarm value	[R-u]			0.5 to 4.0 A (See note 1.)	4.0 A (See note 1.)	
Overcurrent alarm type	[R-t]			Standard or instantaneous	Standard	
Undervoltage alarm value	[u-U]	Not lit	V	18.0 to 26.4 V	20 V	
Overvoltage alarm value	[u-ō]			20.0 to 28.8 V	28.8 V	
Run time value	[t-n]			kh	0.0 kh (See note 2.)	
Over-temperature output value	[t-nP]			°C	80°C (See note 3.)	
Startup sequence	[UP5]	Only relevant circuits lit	s	0 to 99.9 s	0 s	
Shutdown sequence	[dU5]			0 to 99.9 s	0 s	
External Tripping Input	[t-rG]	Only relevant circuits lit	None	Valid/Invalid	Valid (Enabled)	
Unit number	[Unō]	Not lit	None	0 to 31	0	
Baud rate	[dP5]			4.8 or 9.6 kbps	9.6 kbps	
Data length	[LEn]			7 or 8 bits	7 bits	
Stop bits	[b-t]			1 or 2 bits	2 bits	
Parity	[PtY]			None, Even, or Odd	Even	
Send wait time	[5Yt]			---	00 to 999 ms	0 ms
Clear run time	[Lr]			---	---	---
				None	---	---

- Note**
- (1) In the S8M-CP04-RS, the setting range is 0.5 to 3.8 A and the default value is 3.8 A.
 - (2) If the run time value is set to 0.0 kh, no alarm will be output.
 - (3) The default setting for the over-temperature output value is 80°C, i.e., the over-temperature output is essentially disabled.

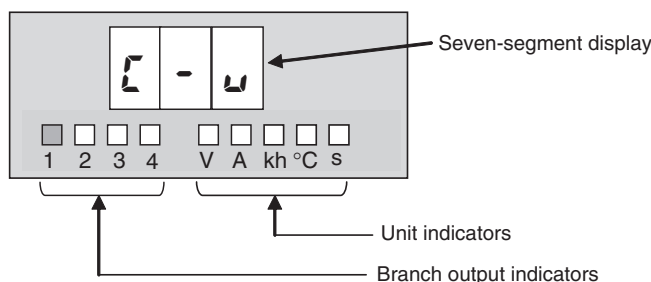

4-3 Switching the Operating Mode

The S8M's parameters are set in Setting Mode. A newly purchased S8M automatically starts in Setting Mode, but it may be necessary to switch to Setting Mode if the S8M has been operated before.

Turning ON a New S8M for the First Time

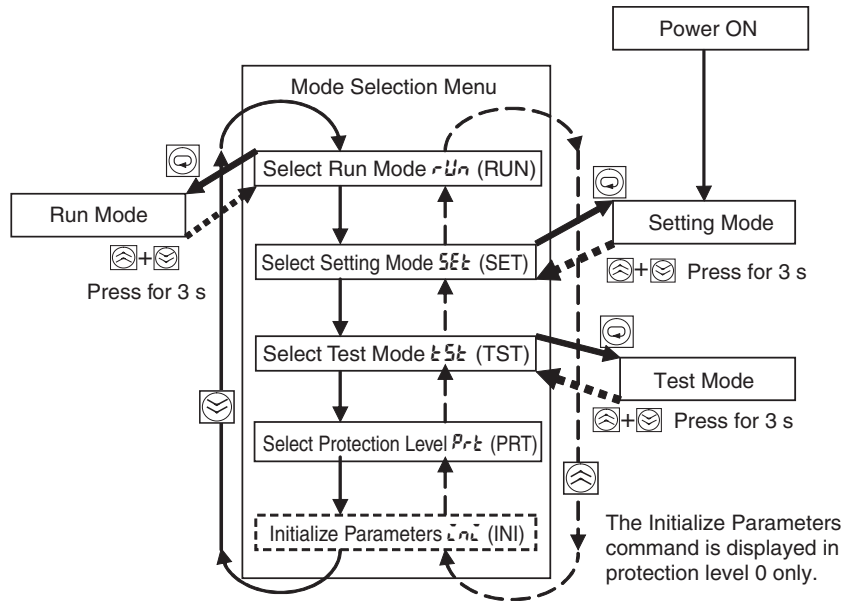

A newly purchased S8M will start in Setting Mode when it is turned ON for the first time.

Normal Power-ON Procedure

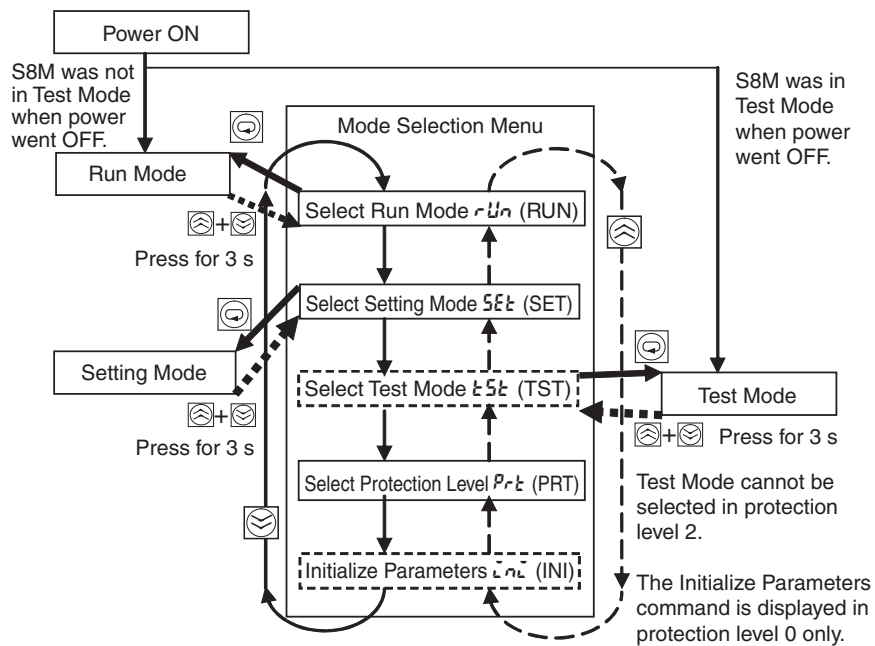

If the S8M was previously turned ON and turned OFF in any mode other than Test Mode, it will start in Run Mode the next time that the power is turned ON. If the S8M was turned OFF in Test Mode, it will start in Test Mode the next time that the power is turned ON.

The Mode Selection Menu can also be used to select the protection level or initialize the parameters (see note).

Note The Initialize Parameters function restores all of the S8M's parameter settings to their default values. For details on default values, refer to 4-2 Parameter Setting Ranges.

**Switching to the
Mode Selection Menu**

A newly purchased S8M will start in Setting Mode when it is turned ON for the first time. If the power is turned OFF with the S8M in Test Mode, it will start in Test Mode the next time it is turned ON. Otherwise, once the S8M has been switched to RUN Mode, it will start in Run Mode when power is turned ON.

Press both the Up Key (⏮) and Down Key (⏭) simultaneously for 3 seconds to display the Mode Selection Menu. If no keys are pressed for 5 seconds while the Mode Selection Menu is displayed, the S8M will automatically return to Run Mode.

Switching between Displays in the Mode Selection Menu

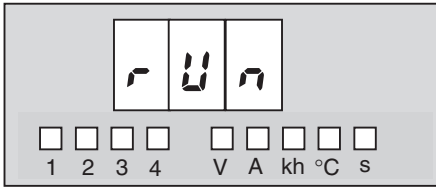

When the S8M is switched to the Mode Selection Menu from Run Mode, the display will show “RUN.” At this point, the S8M will automatically enter Run Mode if the Mode Key (⊕) is pressed or the Up Key (⬆) or Down Key (⬇) isn't pressed within 5 s.

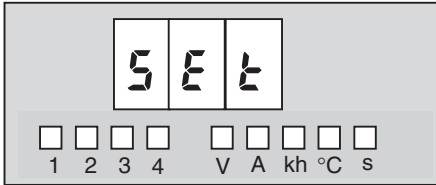
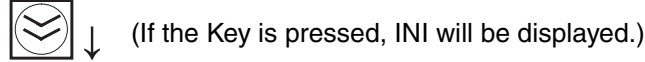

If the Down Key (⬇) is pressed, SET will be displayed. If the Mode Key (⊕) is pressed at this point, the S8M will enter Setting Mode.

Refer to 4-4 *Changing the Protection Level to 4-6 Individual Branch Output Settings* for details on setting parameters.

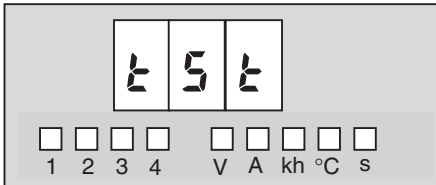

If the Down Key (⬇) is pressed, TST will be displayed. If the Mode Key (⊕) is pressed at this point, the S8M will enter Test Mode.

See SECTION 5 *Trial Operation to Actual Operation* for details on Test Mode.

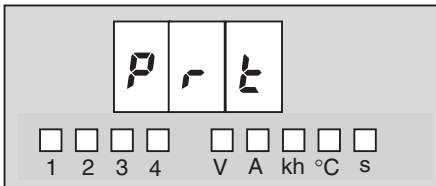

If the Down Key (⬇) is pressed, PRT (protect) will be displayed. If the Mode Key (⊕) is pressed at this point, the S8M will switch to the protection level display.

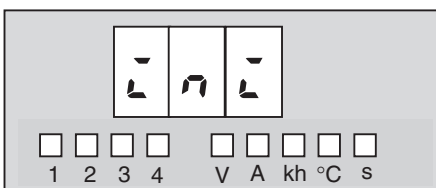

If the protection level is set to level 0, INI will be displayed when the Down Key (⬇) is pressed. If the Mode Key (⊕) is pressed at this point, the S8M will switch to the parameter initialization display.

Note The default protection level is level 1 and the INI option will not be displayed in protection level 1.



(If the Down Key (⬇) is pressed, the S8M will return to the RUN display.)

Note The procedure for initializing parameters is as follows:

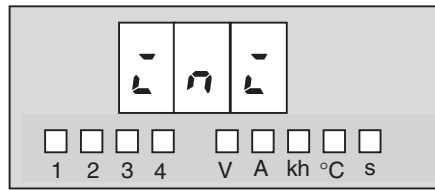

Press the Mode Key (Ⓞ) from the initialize display (INI). The S8M will switch to the parameter initialization display.

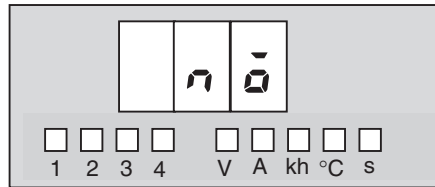

NO will be displayed. Initialization cannot be performed from this display. (The S8M will automatically return to Run Mode if no key is pressed within 5 s.)

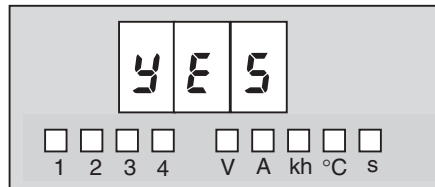

Press the Up Key (Ⓢ). The display will change to YES. The parameters will be initialized if the Mode Key (Ⓞ) is pressed from this display.

(The S8M will automatically return to Run Mode if no key is pressed within 5 s.)

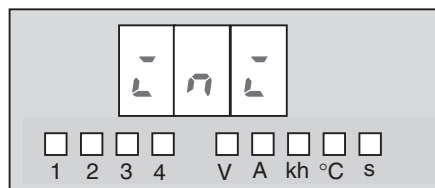

Press the Mode Key (Ⓞ) to start initializing parameters. INI will flash on the display while parameters are being initialized. When the display stops flashing, all parameters will have been initialized.

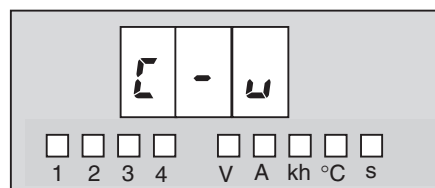

The operating mode will change to Setting Mode and the abnormal voltage tripping value will be displayed for branch output 1.

After the parameters have been initialized, the default settings will be in effect and the initial power-ON status will be used.

- The operating mode will be Setting Mode.
- All branch outputs will be disconnected.
- Protection level 1 will be used.

4-4 Changing the Protection Level

Operations Restricted in the Protection Levels

The protection level function can restrict parameter read/write access to one of three levels, as shown in the following table.

Level	Applicable user	Access
Level 0	System administrator	All parameters can be read and changed.
Level 1	Supervisor	Only operational settings related to voltage and current can be read and changed.
Level 2	General staff	A limited number of parameters can be read. No parameters can be changed.

The default protection level is level 1. When the parameters are initialized, the protection level is set to level 1.

Procedure

The factory default protection level is level 1, so the protection level must be changed in order to switch to level 0. Use the following procedure to change the protection level.

Display the Mode Selection Menu and press the Up Key (⏮) or Down Key (⏭) until the protection level display (PRT) appears.

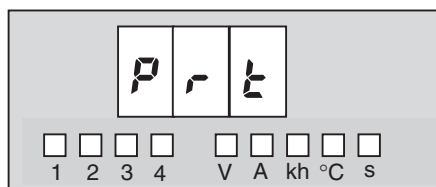

Press the Mode Key (⏮).

The S8M will automatically return to Setting Mode or Run Mode (see note) if no key is pressed within 5 s.

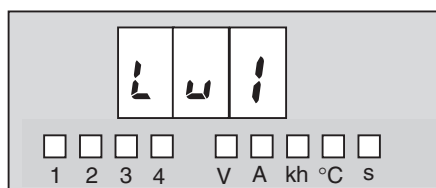

LV1 will be displayed. The present protection level is level 1 (the default value), so press the Down Key (⏭) to change to level 0.

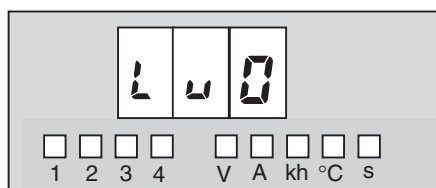

If the Mode Key (⏮) is pressed, the LV0 display will flash. When the display stops flashing, the protection level will be switched to level 0 and the S8M will return to Setting Mode.



Note If the S8M has been turned ON for the first time, it will return to Setting Mode. If the S8M has been in Run Mode before, it will return to Run Mode.

4-5 Switching to Setting Mode

A newly purchased S8M will start in Setting Mode when it is turned ON for the first time. In this case, the seven-segment display will show the current tripping value for branch output 1 (C-V). (For details, see page 56.)

If the S8M was previously turned ON and turned OFF in any mode other than Test Mode, it will start in Run Mode the next time that the power is turned ON. If the S8M was turned OFF in Test Mode, it will start in Test Mode the next time that the power is turned ON.

To switch to Setting Mode from Run Mode or Test Mode, select Setting Mode from the Mode Selection Menu, as shown below. The Mode Selection Menu can be displayed by pressing both the Up Key (⏶) and Down Key (⏷) simultaneously for 3 seconds.

Selecting the Operating Mode from the Mode Selection Menu

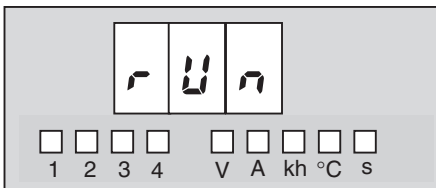

If the S8M is switched to the Mode Selection Menu from Run Mode, RUN (select Run Mode) will be displayed.

Press the Down Key (⏷).

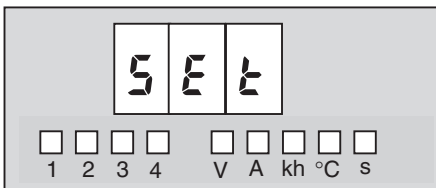

When the Down Key (⏷) is pressed, SET (select Setting Mode) will be displayed.

If the Mode Key (⏻) is pressed, the S8M will switch to Setting Mode.



The initial display for Setting Mode will be displayed.

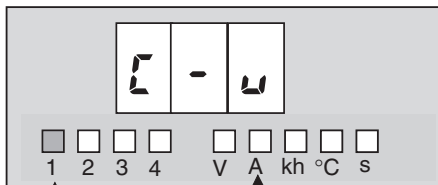

The "A" unit indicator will be lit when a current is displayed.

Branch output number 1 is lit.

The initial Setting Mode display is the current tripping value for branch output 1 (C-V). Once the S8M is switched to Setting Mode, it will not return to Run Mode automatically.

(To return to Run Mode, press the ⏶ and ⏷ Keys simultaneously for 3 seconds again.)

For details on setting parameters in Setting Mode, refer to 4-6 Individual Branch Output Settings.

4-6 Individual Branch Output Settings

This section shows the displays and operations when setting parameters in Setting Mode in protection level 0. If the protection level is set to level 1 or 2, some parameters will not be displayed or will be read-only. (For details, see page 48.)

Setting the Current Tripping Value: C-V (Cutoff Value)

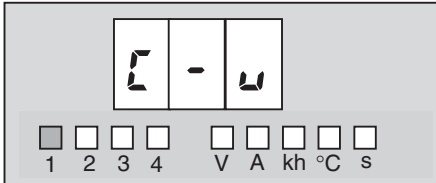

The initial Setting Mode display (C-V) is used to set the current tripping value for branch output 1.



Go to page 57 for settings other than the current tripping value.

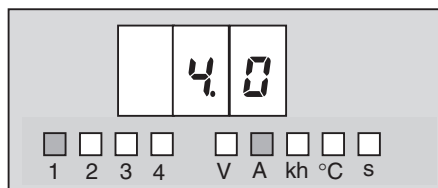

Press the Key to display the set value of the branch output 1 current tripping value. The S8M will automatically return to the C-V display if no key is pressed within 3 s.

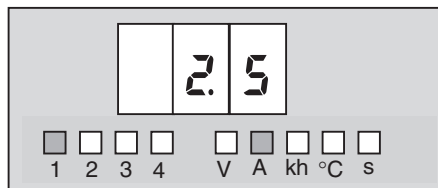

The set value can be changed by pressing the and Keys (see note). The setting range is 0.5 to 4.0 A (0.1 A units) for the S8M-CP04/CP04-R and 0.5 to 3.8 A (0.1 A units) for the S8M-CP04-RS.

Note If the or Key is pressed for more than 2 s, the SV will change in 1.0 A units instead of 0.1 A units.



(Return to C-V display.)

When the Key is pressed, the SV display will flash. When the flashing stops, the new SV will be saved and the S8M will return to C-V display. If you want to confirm the new setting, press the Key again from the C-V display.

Note If the branch output's current exceeds the set value, the output will be cut off. The current tripping type is set with the following C-T (cutoff type) display. The tripping type can be set in protection level 0 only. After an output is cut off, the seven-segment display will alternately show error code A11 and the current, and the Tripping Alarm Output (TRP) will be turned OFF. The error can be cleared immediately, but the next error cannot be cleared for another 15 s.

Setting the Current Tripping Type: C-T (Cutoff Type)

This parameter can be set in protection level 0 only.

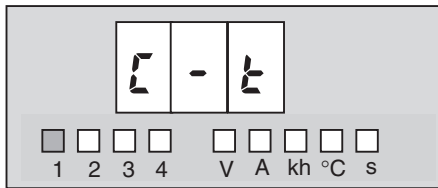

If the S8M is in protection level 0, press the Key from the current tripping value (C-V) display to switch to the current tripping type setting display.

Select the tripping type for branch output 1.



Go to page 58 for the overcurrent alarm value setting.

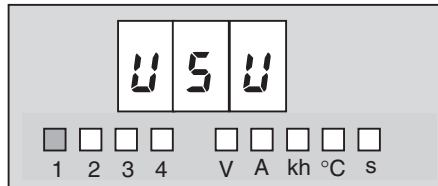

Press the Key to display the setting.

INS: Instantaneous detection trips if the excessive current lasts over 10 ms. The output can be cut off within 20 ms.

USU: Standard detection trips if the excessive current lasts over 80 ms. The output can be cut off within 100 ms.

The setting can be changed by pressing the or Key.

The S8M will automatically return to the C-T display if no key is pressed within 3 s.

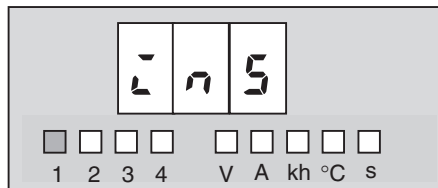

(Return to C-T display.)

When the Key is pressed, the SV display will flash. When the flashing stops, the new setting will be saved and the S8M will return to C-T display.

If you want to confirm the new setting, press the Key again from the C-T display.

Standard (U5U)	When the current exceeds the tripping value for more than 80 ms, the branch output is cut off and the Tripping Alarm Output (TRP) is turned OFF. The output will be cut off within 100 ms.
Instantaneous (L n 5)	When the current exceeds the tripping value for more than 10 ms, the branch output is cut off and the Tripping Alarm Output (TRP) is turned OFF. The output will be cut off within 20 ms.

Setting the Overcurrent Alarm Value A-V: (Alarm Value)

When the  Key is pressed from the current tripping type (C-T) display, the display will switch to the overcurrent alarm value setting display (A-V).

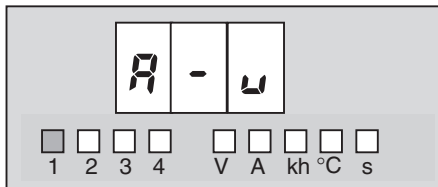



This parameter sets the overcurrent alarm value for branch output 1.



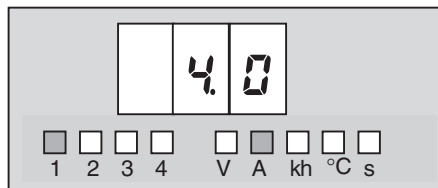

Go to page 59 for the overcurrent alarm type setting.



Press the  Key to display the overcurrent alarm's set value (SV). The SV can be changed by pressing the  and  Keys (see note).

The setting range is 0.5 to 4.0 A (0.1 A units) for the S8M-CP04/CP04-R and 0.5 to 3.8 A (0.1 A units) for the S8M-CP04-RS.

Note If the  or  Key is pressed for more than 2 s, the SV will change in 1.0 A units instead of 0.1 A units.

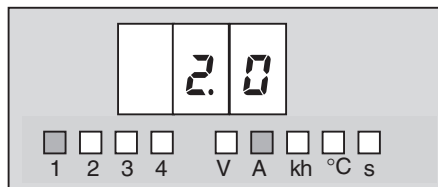

The S8M will automatically return to the A-V display if no key is pressed within 3 s.



(Return to A-V display.)

When the  Key is pressed, the SV display will flash. When the flashing stops, the new setting will be saved and the S8M will return to A-V display.

If you want to confirm the new setting, press the  Key again from the A-V display.

Note If the current exceeds the SV for 80 ms or 10 ms, the Alarm Output (ALM) will be turned OFF and the seven-segment display will alternate between error code A22 and the measured current. The alarm output can be cleared after the current falls and remains below the SV for more than 500 ms. The overcurrent alarm type is set with the following A-T (alarm type) display. The alarm type can be set in protection level 0 only.

Setting the Overcurrent Alarm Type: A-T (Alarm Type)

If the S8M is in protection level 0, press the  Key from the overcurrent alarm value (A-V) display to switch to the overcurrent alarm type setting (A-T) display.

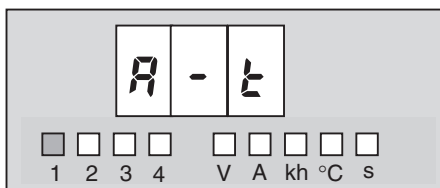

Select the overcurrent alarm type for branch output 1.



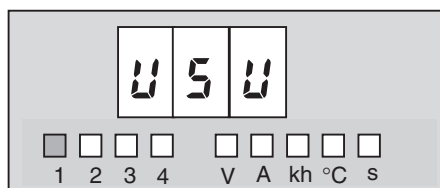

Go to page 60 for the branch output 2 current tripping value setting.



Press the  Key to display the setting.
 INS: Instantaneous detection operates if the excessive current lasts over 10 ms.
 USU: Standard detection operates if the excessive current lasts over 80 ms.



The setting can be changed by pressing the  and  Key.

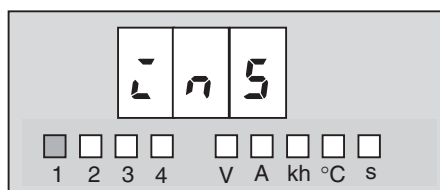

The S8M will automatically return to the A-T display if no key is pressed within 3 s.



(Return to A-T display.)

When the  Key is pressed, the SV display will flash. When the flashing stops, the new setting will be saved and the S8M will return to A-T display.

If you want to confirm the new setting, press the  Key again from the A-T display.

Standard (USU)	When the current exceeds the alarm value for more than 80 ms, the Alarm Output (ALM) is turned OFF within 100 ms.
Instantaneous (INS)	When the current exceeds the alarm value for more than 10 ms, the Alarm Output (ALM) is turned OFF within 20 ms.

When necessary, refer to the procedures on pages 56 to 59 and set the parameters for branch outputs 2 to 4.

If the Down Key () is pressed from the overcurrent alarm type setting display (A-T) for branch output 4, the display will switch to the undervoltage alarm value setting display (V-U) described in 4-7 Shared Parameter Settings.

4-7 Shared Parameter Settings

Setting the Undervoltage Alarm Value: V-U (Voltage Under)

Setting the overcurrent alarm type (A-T) for branch output 4 is the last step of the current tripping function and overcurrent alarm function settings for branch outputs 1 to 4. If the Down Key (⏏) is pressed from the A-T display for branch output 4, the display will switch to the undervoltage alarm value setting display (V-U).

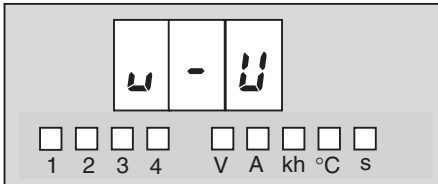

This parameter sets the undervoltage alarm value.



Switch to the overvoltage alarm value setting.

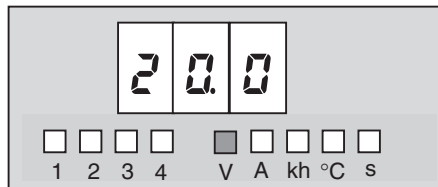

Press the ⏏ Key to display the undervoltage alarm's set value (SV). The SV can be changed by pressing the ⏏ and ⏏ Keys (see note).

The setting range is 18.0 to 26.4 V (0.1 V units).

Note If the ⏏ or ⏏ Key is pressed for more than 2 s, the SV will change in 1.0 V units instead of 0.1 V units.

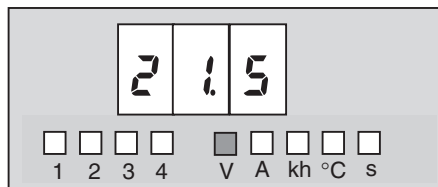

Change the SV with the ⏏ and ⏏ Keys. The S8M will automatically return to the V-U display if no key is pressed within 3 s.



(Return to V-U display.)

When the ⏏ Key is pressed, the SV display will flash. When the flashing stops, the new setting will be saved and the S8M will return to V-U display.

If you want to confirm the new setting, press the ⏏ Key again from the V-U display.

Note If the voltage is below the SV for 80 ms, the Alarm Output (ALM) will be turned OFF and the seven-segment display will alternate between error code A21 and the measured voltage. The alarm output can be cleared after the voltage rises above the SV +0.3 V for more than 500 ms.

Setting the Overvoltage Alarm Value: V-O (Voltage Over)

If the Down Key (⏏) is pressed from the undervoltage alarm value setting display (V-U), the display will switch to the overvoltage alarm value setting display (V-O).

This parameter sets the overvoltage alarm value.

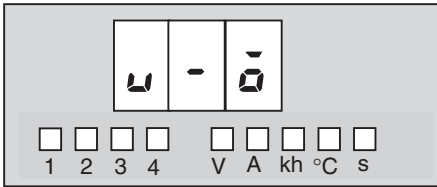

Switch to the run time value setting.

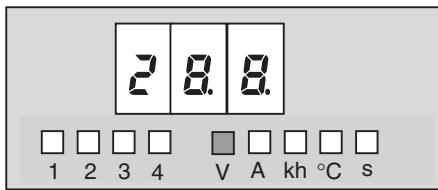

Press the ⏏ Key to display the overvoltage alarm's set value (SV). The SV can be changed by pressing the ⏏ and ⏏ Keys (see note).

The setting range is 20.0 to 28.8 V (0.1 V units).

Note If the ⏏ or ⏏ Key is pressed for more than 2 s, the SV will change in 1.0 V units instead of 0.1 V units.

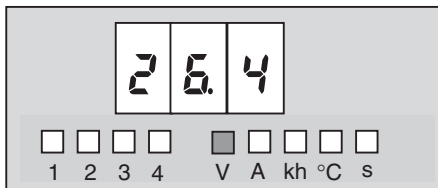

Change the SV with the ⏏ and ⏏ Keys.

The S8M will automatically return to the V-O display if no key is pressed within 3 s.



(Return to V-O display.)

When the ⏏ Key is pressed, the SV display will flash. When the flashing stops, the new setting will be saved and the S8M will return to V-O display.

If you want to confirm the new setting, press the ⏏ Key again from the V-O display.

Note If the voltage exceeds the SV for 80 ms, the Alarm Output (ALM) will be turned OFF and the seven-segment display will alternate between error code A20 and the measured voltage.

The alarm output can be cleared after the voltage falls below the SV -0.3 V for more than 500 ms.

Setting the Run Time Value: TIM (Time)

If the Down Key (⏏) is pressed from the overvoltage alarm value setting display (V-O), the display will switch to the run time value setting display (TIM).

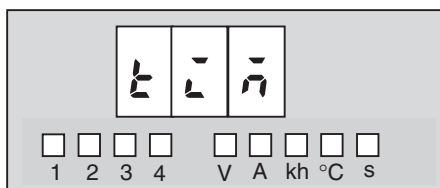

This parameter sets the run time value.



Switch to the over-temperature output value setting.

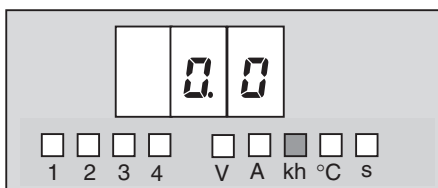

Press the → Key to display the run time alarm's set value (SV). The SV can be changed by pressing the ← and → Keys (see note).

The setting range is 0.0 to 99.9 kh (99,900 h), set in 100 hour units.

Note If the ← or → Key is pressed for more than 2 s, the SV will change in 1.0 kh units instead of 0.1 kh units.

The run time alarm won't be output if the SV is set to 0.0 kh.

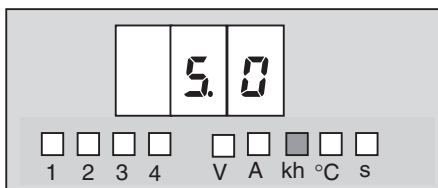

Change the SV with the ← and → Keys.

The S8M will automatically return to the TIM display if no key is pressed within 3 s.

When the → Key is pressed, the SV display will flash. When the flashing stops, the new setting will be saved and the S8M will return to TIM display.

If you want to confirm the new setting, press the → Key again from the TIM display.



(Return to TIM display.)

Note When the run time exceeds the SV, the Alarm Output (ALM) will be turned OFF and the seven-segment display will alternate between error code A23 and the measured run time.

Set the run time value to 0.0 kh when run time alarms are not required.

The run time (PV) can be cleared to reset the timer. For details, refer to page 71.

When an alarm is being output because the run time exceeds the alarm value (SV), the alarm output can be cleared by clearing the run time (PV).

Setting the Over-temperature Output Value: TMP (Temperature)

If the Down Key (⏏) is pressed from the run time value setting display (TIM), the display will switch to the over-temperature output value setting display (TMP).

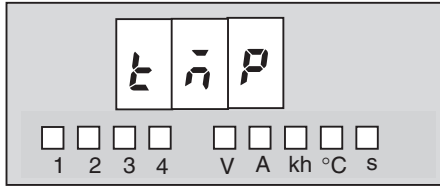

This parameter sets the over-temperature output value.



Switch to the startup sequence setting.

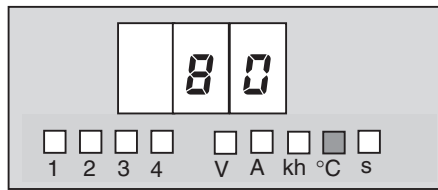

Press the ⏏ Key to display the over-temperature output value (SV). The SV can be changed by pressing the ⏏ and ⏏ Keys (see note). The setting range is 25°C to 80°C. Change the SV with the ⏏ and ⏏ Keys (see note). The S8M will automatically return to the TMP display if no key is pressed within 3 s.

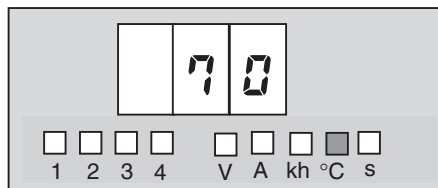

Note If the ⏏ or ⏏ Key is pressed for more than 2 s, the SV will change in 10°C units instead of 1°C units.



(Return to TMP display.)

When the ⏏ Key is pressed, the SV display will flash. When the flashing stops, the new setting will be saved and the S8M will return to TMP display.

If you want to confirm the new setting, press the ⏏ Key again from the TMP display.

- Note**
- (1) If the temperature exceeds the SV for more than 1 s, the over-temperature output (TMP) will be turned OFF and the seven-segment display will alternate between error code A30 and the measured temperature.
 - (2) The error display and over-temperature output are reset automatically after the temperature falls and remains below the set value – 3°C for more than 5 s.
 - (3) The over-temperature output (TMP) operates independently of the other external outputs. This output can be received as a normally closed output and used to start an exhaust fan or air conditioner to reduce the temperature in the control panel. (For details, refer to page 28.)

4-8 Special Settings and Communications Settings

The startup sequence setting display (UPS) will appear if the S8M is in protection level 0 and the Down Key (⏏) is pressed from the over-temperature output value setting display (TMP), which was described at the end of 4-7 Shared Parameter Settings.

Setting the Startup Sequence: UPS (Startup Sequence)

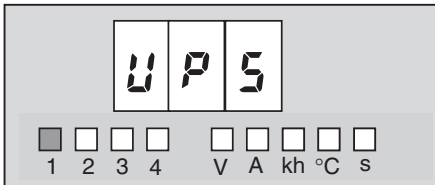

The startup sequence sets the startup sequence time for each branch output. (The startup sequence time is the time the S8M waits before connecting each branch output.)



Switch to the startup sequence setting for branch output 2.

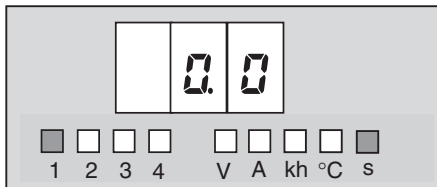

Press the ⏏ Key to display the startup sequence time set value (SV) for branch output 1. The SV can be changed by pressing the ⏏ and ⏏ Keys (see note). The setting range is 0.0 to 99.9 s (0.1 s units).

Note If the ⏏ or ⏏ Key is pressed for more than 2 s, the SV will change in 1.0 s units instead of 0.1 s units.



Change the SV with the ⏏ and ⏏ Keys. The S8M will automatically return to the UPS display if no key is pressed within 3 s.

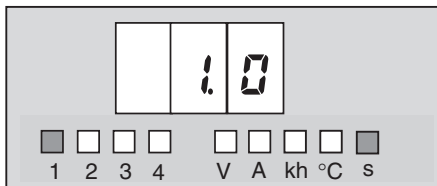

When the ⏏ Key is pressed, the SV display will flash. When the flashing stops, the new setting will be saved and the S8M will return to UPS display.

If you want to confirm the new setting, press the ⏏ Key again from the UPS display.

Press the ⏏ Key to switch to the startup sequence time settings for branch outputs 2, 3, and 4. The other startup sequence times are set just like the branch output 1 startup sequence time.



(Return to UPS display.)

Press the ⏏ Key to switch to the startup sequence time settings for branch outputs 2, 3, and 4. Set those startup sequence times when required.

If the Down Key (⏏) is pressed from the startup sequence setting display (UPS) for branch output 4, the display will switch to the shutdown sequence setting display (DWS).

Note The startup sequence sets a delay before the S8M connects the branch output after the power is turned ON. Connecting the branch outputs in sequence instead of simultaneously can reduce the inrush current and reduce the load on the power supply. For details on the startup sequence, refer to 2-5 Startup Sequence Function.

Setting the Shutdown Sequence: DWS (Shutdown Sequence)

The shutdown sequence setting display (DWS) will be displayed when the Down Key (⏏) is pressed from the startup sequence setting display (UPS) for branch output 4.

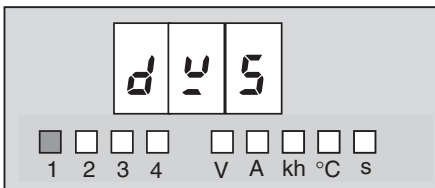

The shutdown sequence sets the shutdown sequence time for each branch output (the time that the S8M waits before disconnecting each branch output when the power is turned OFF).



Switch to the shutdown sequence setting for branch output 2.

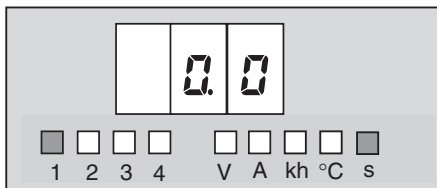

Press the ⏏ Key to display the shutdown sequence time set value (SV) for branch output 1. The SV can be changed by pressing the ⏏ and ⏏ Keys. The setting range is 0.0 to 99.9 s (0.1 s units). Change the SV with the ⏏ and ⏏ Keys (see note). The S8M will automatically return to the DWS display if no key is pressed within 3 s.

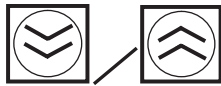

Note If the ⏏ or ⏏ Key is pressed for more than 2 s, the SV will change in 1.0 s units instead of 0.1 s units.

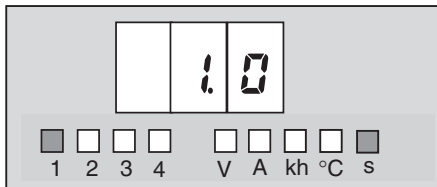

When the ⏏ Key is pressed, the SV display will flash. When the flashing stops, the new setting will be saved and the S8M will return to DWS display.



(Return to DWS display.)

If you want to confirm the new setting, press the ⏏ Key again from the DWS display.

Press the ⏏ Key to switch to the shutdown sequence time settings for branch outputs 2, 3, and 4. Set those shutdown sequence times when required.

If the Down Key (⏏) is pressed from the shutdown sequence setting display (DWS) for branch output 4, the display will switch to the external tripping input setting display (TRG).

Note The shutdown sequence function sets the time that the S8M waits before cutting off each branch output when the branch outputs are cut off by the external tripping input or communications. For details on the startup sequence, refer to 2-6 Shutdown Sequence Function.

External Tripping Input: TRG (Trigger)

The external tripping input setting (TRG) will be displayed when the Down Key (⏏) is pressed from the shutdown sequence setting display (DWS) for branch output 4.

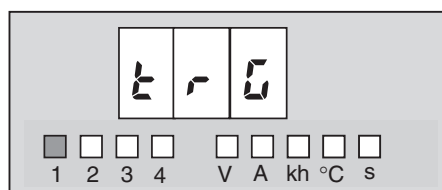

The external tripping input (TRG) can be enabled and disabled independently for each branch output.



Switch to the external tripping input setting for branch output 2.

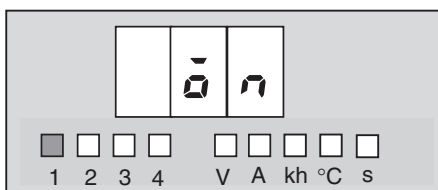

Press the ⏏ Key to display the external tripping input setting. The setting can be changed by pressing the ⏏ or ⏏ Key.

ON (enabled/valid): The corresponding branch output will be cut off when the TRG input is ON.

OFF (disabled/invalid): The TRG input has no effect on the corresponding branch output.

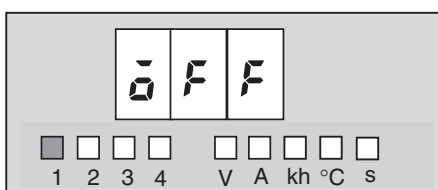

Change the setting with the ⏏ or ⏏ Key.

The S8M will automatically return to the TRG display if no key is pressed within 3 s.



(Return to TRG display.)

When the ⏏ Key is pressed, the SV display will flash. When the flashing stops, the new setting will be saved and the S8M will return to TRG display.

If you want to confirm the new setting, press the ⏏ Key again from the TRG display.

Press the ⏏ Key to switch to the external tripping input settings for branch outputs 2, 3, and 4. Enable/disable the external tripping input for those branch outputs as required.

If the Down Key (⏏) is pressed from the external tripping input setting display (TRG) for branch output 4, the display will switch to the unit number setting display (UNO).

- Note**
- (1) If the External Tripping Input (TRG) is enabled for any branch outputs, those outputs will be cut off within 20 ms when the TRG input is ON for more than 10 ms.
 - (2) The shutdown delays specified by the shutdown sequence times will be applied before disconnecting each output.
 - (3) When the TRG input goes ON, the seven-segment display will indicate "TRG."
 - (4) Once the TRG input goes OFF, the cut-off branch outputs can be reconnected by pressing the Reset Key for 3 s or longer.
 - (5) When all outputs are cut off simultaneously in Test mode or the shutdown sequence operation is executed via communications, the branch outputs will be cut off regardless of the external tripping input setting.

Unit Number Setting: UNO (Unit Number)

The unit number setting display (UNO) will be displayed when the Down Key (⏴) is pressed from the external tripping input display (TRG) for branch output 4.

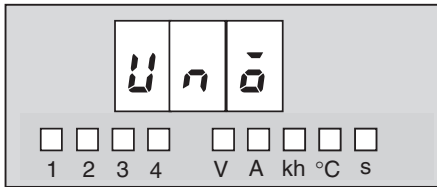

Set the S8M's unit number when using 1:N communications with the host computer. The unit number can be left at its default value (0) when communicating 1:1 with the computer.



Switch to the baud rate setting.

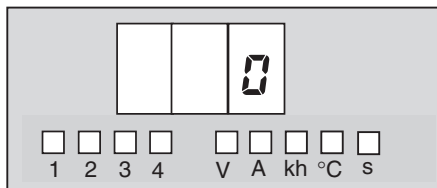

Press the → Key to display the unit number setting. The setting can be changed by pressing the → and ← Keys (see note).

Note If the → or ← Key is pressed for more than 2 s, the SV will change by 10s instead of 1s.



The setting range is 0 to 31. The unit number can be left at 0 when communicating 1:1 with the computer. Change the SV with the → and ← Keys. The S8M will automatically return to the UNO display if no key is pressed within 3 s.

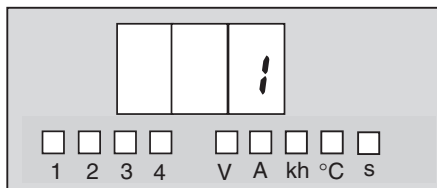

When the → Key is pressed, the setting will flash. When the flashing stops, the new setting will be saved and the S8M will return to UNO display.

If you want to confirm the new setting, press the → Key again from the UNO display.



(Return to UNO display.)

If the Down Key (⏴) is pressed from the UNO display, the display will switch to the baud rate setting display (BPS).

Baud Rate: BPS (Bits Per Second)

The baud rate setting display (BPS) will be displayed if the Down Key (⏴) is pressed from the unit number setting display (UNO).

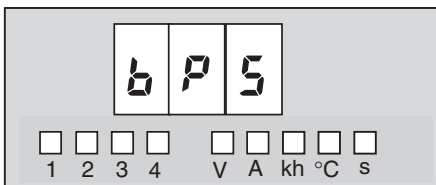

This parameter sets the RS-232C port's baud rate to 4,800 bps or 9,600 bps.



Switch to the data length setting.

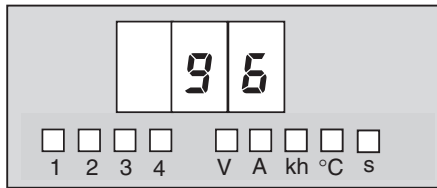

Press the Key to display the baud rate setting. The setting can be changed by pressing the or Key.

96: 9,600 bps
48: 4,800 bps

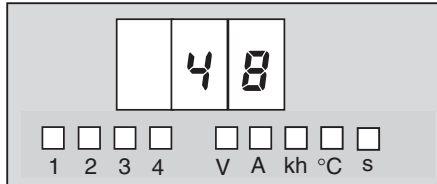

Change the setting with the or Key. The S8M will automatically return to the BPS display if no key is pressed within 3 s.



(Return to "BPS" display.)

When the Key is pressed, the setting will flash. When the flashing stops, the new setting will be saved and the S8M will return to the "BPS" display.

If you want to confirm the new setting, press the Key again from the BPS display.

If the Down Key () is pressed from the "BPS" display, the display will switch to the data length setting display (LEN).

Data Length: LEN (Bit Length)

The data length setting display (LEN) will be displayed if the Down Key () is pressed from the baud rate setting display (BPS).

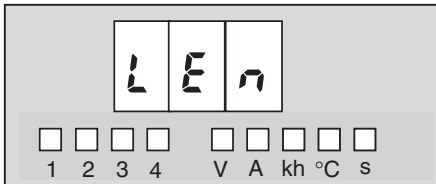

This parameter sets the data length to 7 or 8 bits.



Switch to the stop bits setting.

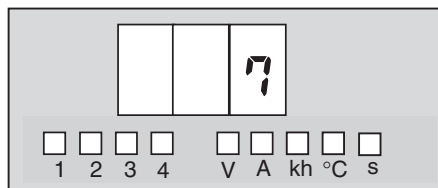

Press the Key to display the data length setting. The setting can be changed by pressing the or Key.

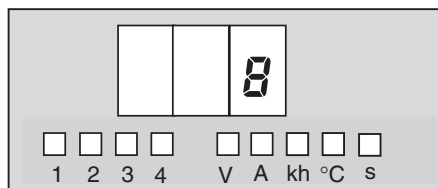

7: 7 bits
8: 8 bits



Change the setting with the or Key. The S8M will automatically return to the LEN display if no key is pressed within 3 s.



(Return to LEN display.)

When the  Key is pressed, the setting will flash. When the flashing stops, the new setting will be saved and the S8M will return to the LEN display. If you want to confirm the new setting, press the  Key again from the LEN display.

If the Down Key () is pressed from the LEN display, the display will switch to the stop bit setting display (BIT).

Stop Bit Setting: BIT (Stop Bits)

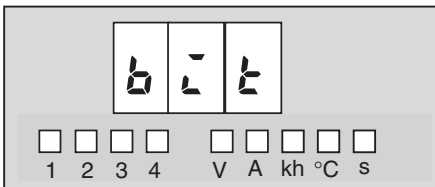

The stop bit setting display (BIT) will be displayed if the Down Key () is pressed from the data length setting display (LEN).

This parameter sets the number of stop bits to 1 bit or 2 bits.



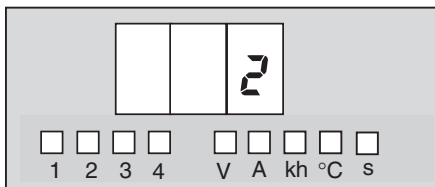

Switch to the parity setting.

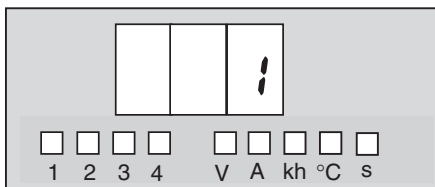
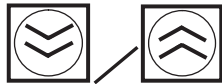

Press the  Key to display the stop bit setting. The setting can be changed by pressing the  or  Key.

- 1: 1 bit
- 2: 2 bits





Change the setting with the  or  Key. The S8M will automatically return to the "BIT" display if no key is pressed within 3 s.



(Return to "BIT" display.)

When the  Key is pressed, the setting will flash. When the flashing stops, the new setting will be saved and the S8M will return to the "BIT" display.

If you want to confirm the new setting, press the  Key again from the "BIT" display.

If the Down Key () is pressed from the "BIT" display, the display will switch to the parity setting display (PTY).

Parity Setting: PTY (Parity Bit)

The parity setting display (PTY) will be displayed if the Down Key (⏏) is pressed from the stop bit setting display (BIT).

This parameter sets the parity to none, even, or odd.

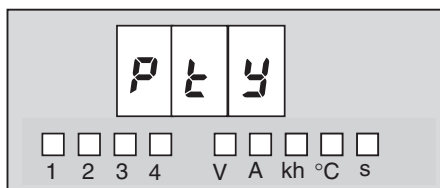

Switch to the send wait time setting.

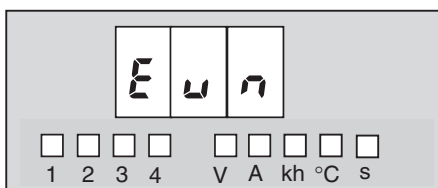

Press the ⏏ Key to display the parity setting. The setting can be changed by pressing the ⏏ and ⏏ Keys.

- non: None
- Evn: Even
- odd: Odd

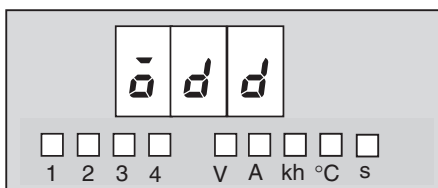

Change the setting with the ⏏ or ⏏ Key. The S8M will automatically return to the PTY display if no key is pressed within 3 s.

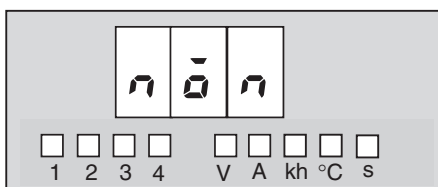

Change the setting with the ⏏ or ⏏ Key.



(Return to "PTY" display.)

When the ⏏ Key is pressed, the setting will flash. When the flashing stops, the new setting will be saved and the S8M will return to the PTY display. If you want to confirm the new setting, press the ⏏ Key again from the PTY display.

If the Down Key (⏏) is pressed from the PTY display, the display will switch to the send wait time setting display (SWT).

Send Wait Time: SWT (Send Wait Time)

The send wait time setting display (SWT) will be displayed if the Down Key (⏏) is pressed from the parity setting display (PTY).

This parameter sets the RS-232C port's send wait time.

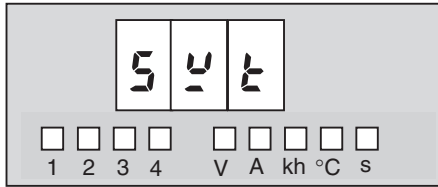

Switch to the run time clear operation.

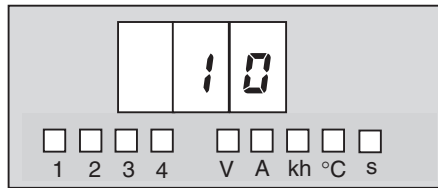
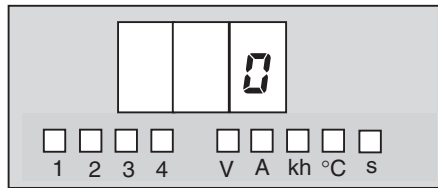

(Return to SWT display.)

If the Down Key (⏏) is pressed from the SWT display, the display will switch to the run time clear display (CLR).

Press the ⏏ Key to display the send wait time setting. The setting can be changed by pressing the ⏏ and ⏏ Keys (see note). The setting range is 0 to 999 ms.

Note If the ⏏ or ⏏ Key is pressed for more than 2 s, the SV will change in 10 ms units instead of 1 ms units.

Change the setting with the ⏏ and ⏏ Keys. The S8M will automatically return to the SWT display if no key is pressed within 3 s.

When the ⏏ Key is pressed, the setting will flash. When the flashing stops, the new setting will be saved and the S8M will return to SWT display.

If you want to confirm the new setting, press the ⏏ Key again from the SWT display.

Run Time Clear: CLR (Time Clear)

The run time clear display will be displayed if the Down Key (⏏) is pressed from the send wait time setting display (SWT).

This operation resets the run time to 0.

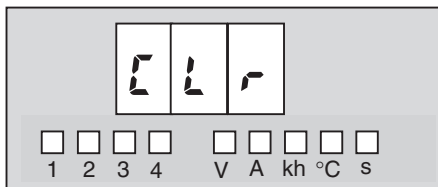

Switch to the current tripping value setting for branch output 1.

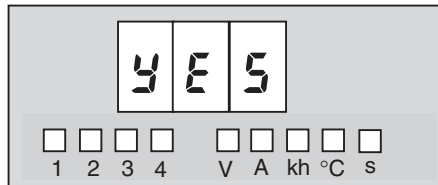
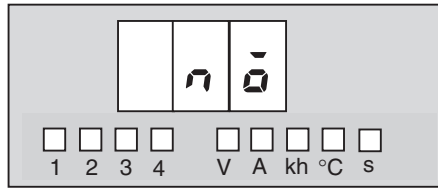

(Return to CLR display.)

Press the Key to display the run time clear setting. The setting can be changed by pressing the or Key.

No: Do not clear the run time.

Yes: Clear the run time.

Change the setting with the or Key. The S8M will automatically return to the CLR display if no key is pressed within 3 s.

When the Key is pressed, the setting will flash and the setting will be read when the flashing stops. If "yes" was selected, the run time will be cleared and the S8M will return to CLR display.

If you want to confirm that the run time was cleared, read the run time in Run Mode.

If the Down Key () is pressed from the CLR display, the display will switch to the current tripping value setting (C-V) for branch output 1.

SECTION 5

Trial Operation to Actual Operation

A connection test can be performed on each branch output in Test Mode.

After installing the S8M, wiring, and setting the parameters, the connection test can be used to test operation before actual operation.

When the S8M is shipped from the factory, all branch outputs are disconnected. The branch outputs that are being used must be connected in Test Mode.

5-1	Test Mode	74
5-2	Connection/Disconnection Test	76
5-3	Checking Sequence Operation	77
5-4	Run Mode	78

5-1 Test Mode

Each branch output's connection status can be checked and the outputs can be connected manually in Test Mode before starting actual operation of the equipment.

The S8M must be set to protection level 0 or 1 in order to switch to Test Mode. (It is not possible to switch to Test Mode when the S8M is set to protection level 2.)

Precautions when Checking Operation

Before checking operation in Test Mode, always verify that it is safe to do so and will not adversely affect the system.

Setting the Branch Outputs That Will Be Used

When the S8M is shipped from the factory, all branch outputs are disconnected, so the outputs will not start connecting when the power is first turned ON.

After setting the parameters in Setting Mode, switch to Test Mode, connect the branch outputs that will be used, and then switch to Run Mode.

- The settings will not be saved if the power is turned OFF while the S8M is still in Test Mode. The S8M will restart in Test Mode and all branch outputs will be disconnected.
- If any branch outputs are disconnected when the S8M is switched from Test Mode to Run Mode, those outputs will remain disconnected.

Errors Occurring During the Connection Test

When an error occurs in Test Mode or the external tripping input is turned ON, the tripping operation will be executed and the appropriate external output will be turned OFF, but the error code will not be displayed. The errors cannot be cleared with the Reset Key.

When the S8M is switched to Run Mode, the error code will be displayed and it will be possible to clear the error with the Reset Key.

Switching to Test Mode

After setting the parameters in Setting Mode, press the Up Key (⬆) and Down Key (⬇) together for at least 3 s to switch to the Mode Selection Menu and select Test Mode.

Once the S8M has been switched to Run Mode, it will start in either Run Mode or Test Mode (see note 1) the next time that the power is turned ON, so press the Up and Down Keys together for 3 s to switch to the Mode Selection Menu (see note 2).

- Note**
- (1) When the S8M is turned OFF in Test Mode, it will restart in Test Mode.
 - (2) If no keys are pressed for 5 s while the Mode Selection Menu is displayed, the S8M will automatically switch to Run Mode (Setting Mode if the S8M is being used for the first time).

Operations and Displays in the Mode Selection Menu

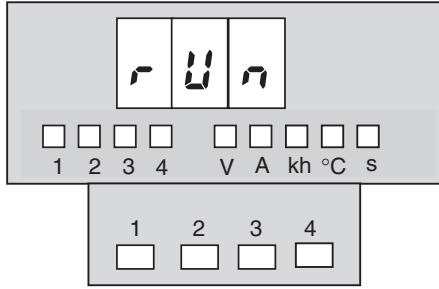

In a newly purchased S8M, no branch outputs are connected, so none of the status indicators is lit.

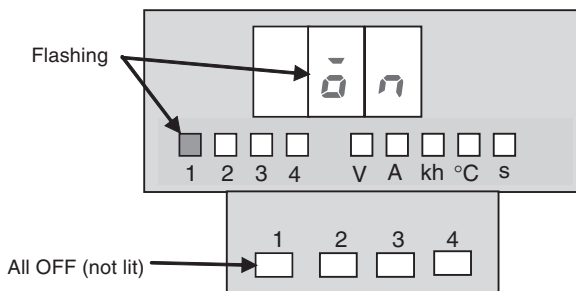
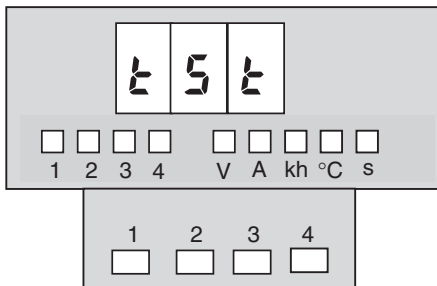
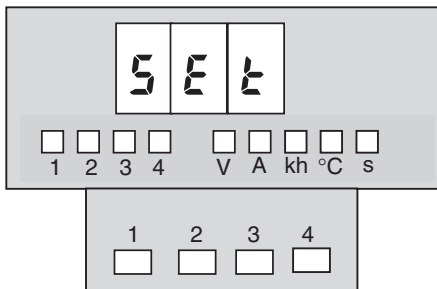

If the S8M is switched to the Mode Selection Menu from Run Mode, RUN will be displayed on the seven-segment display. If the S8M is switched to the Mode Selection Menu from Setting Mode, SET will be displayed on the seven-segment display.

The S8M will enter Run Mode from this display if the Mode Key (⊕) is pressed. Also, the S8M will enter Run Mode automatically if neither the Up Key (⊕) nor Down Key (⊖) is pressed within 5 s.

If the Down Key (⊖) is pressed, SET will be displayed. At this point, the S8M will switch to Setting Mode if the Mode Key (⊕) is pressed.

If no keys are pressed within 5 s, the S8M will automatically return to the last operating mode (Setting Mode if the S8M is new). For details on parameter settings, refer to *SECTION 4 Parameter Settings*.

If the Down Key (⊖) is pressed, TST will be displayed. At this point, the S8M will switch to Test Mode if the Mode Key (⊕) is pressed.

If no keys are pressed within 5 s, the S8M will automatically return to the last operating mode (Setting Mode if the S8M is new).

Press the Mode Key (⊕) to change to Test Mode.

The flashing “on” display indicates that the S8M is ready to connect branch output 1.

5-2 Connection/Disconnection Test

Before performing the connection/disconnection test in Test Mode, always verify that it is safe to do so and will not adversely affect the system.

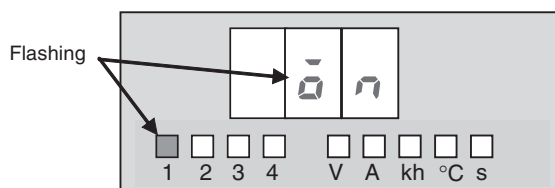

The flashing “on” display indicates that the S8M is ready to connect branch output 1.

To connect branch output 1, press the Mode Key (Ⓞ).

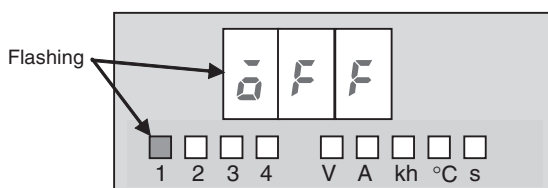
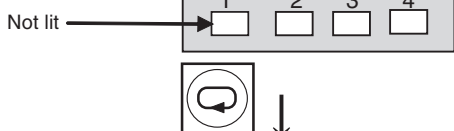

If the Mode Key (Ⓞ) is pressed, branch output 1 will be connected and the output 1 indicator will light.

The seven-segment display will flash the word “off” to indicate that the S8M is ready to disconnect branch output 1.

(If the Mode Key (Ⓞ) is pressed again, branch output 1 will be disconnected.)

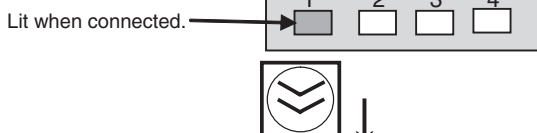

If branch output 2 will be connected, press the Down Key (Ⓜ).

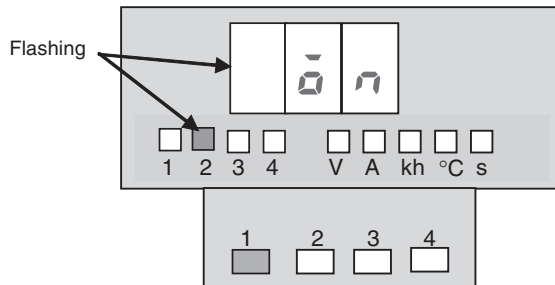

If the Down Key (Ⓜ) is pressed, the display will flash the word “on” to indicate that the S8M is ready to connect branch output 1.

To connect branch output 2, press the Mode Key (Ⓞ).

Use the procedure above to test each branch output's connection and connect the branch outputs that will be used.

Note Be sure to connect the branch outputs that will be used. If a branch output is not connected when the S8M is switched to Run Mode, that branch output cannot be used. Either return to Test Mode and connect the output or connect it using communications.

If the Down Key (Ⓜ) is pressed a second time when connecting/disconnecting branch output 4, the indicators for all branch outputs will flash and all branch outputs can be connected and disconnected at the same time. Refer to 5-3 *Checking Sequence Operation*.

5-3 Checking Sequence Operation

When you want to check the operation of the startup sequence function or shutdown sequence function, press the Up Key (⏮) or Down Key (⏭) until all of the branch output indicators are flashing.



Press the Up Key (⏮) or Down Key (⏭) until branch output indicators 1 to 4 are flashing.

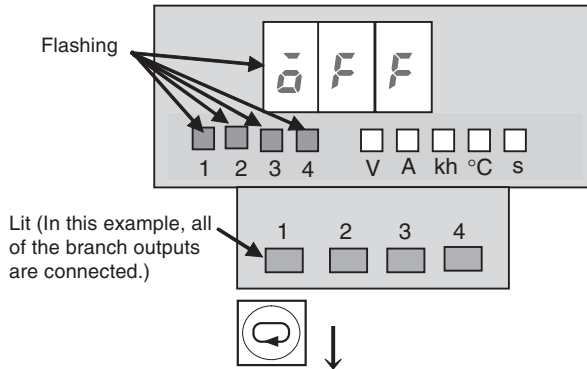

Press the Down Key (⏭) until branch output indicators 1 to 4 are flashing, which indicates that the S8M is ready to simultaneously cut off all of the branch outputs.

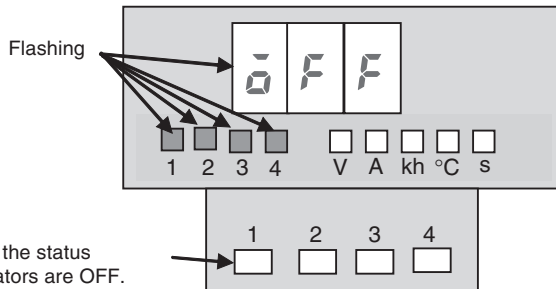

If the Mode Key (⏻) is pressed, the S8M starts cutting off the outputs simultaneously, and the outputs will be cut off in the pattern specified in the shutdown sequence if the shutdown sequence has been set.

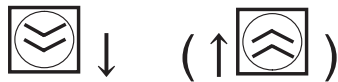

When checking the startup sequence's operation, press the Down Key (⏭) to switch to the flashing "on" display.

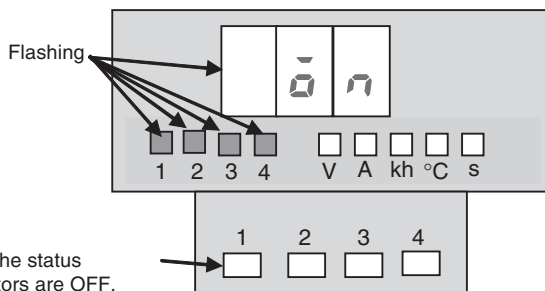

If the Mode Key (⏻) is pressed, the S8M starts connecting the outputs simultaneously, and the outputs will be connected in the pattern specified in the startup sequence if the startup sequence has been set.

When the S8M returns to Run Mode after completing the test, press the Up Key (⏮) and Down Key (⏭) simultaneously for at least 3 s. The display will return to the Mode Selection Menu's TST display. If no keys are pressed for 5 s, the S8M will automatically return to the last operating mode.

If the S8M is turned OFF in Test Mode, it will restart in Test Mode the next time that the power is turned ON.

5-4 Run Mode

Switch to Run Mode after making connection settings and testing operation in Test Mode. When Run Mode is entered from Test Mode, the initial status of the branch outputs will be set. In Run Mode, the present current and peak output current can be read out for branch outputs 1 to 4, along with the total current, run time, and internal temperature. The peak output currents can also be cleared.

Moving from Test Mode to Run Mode

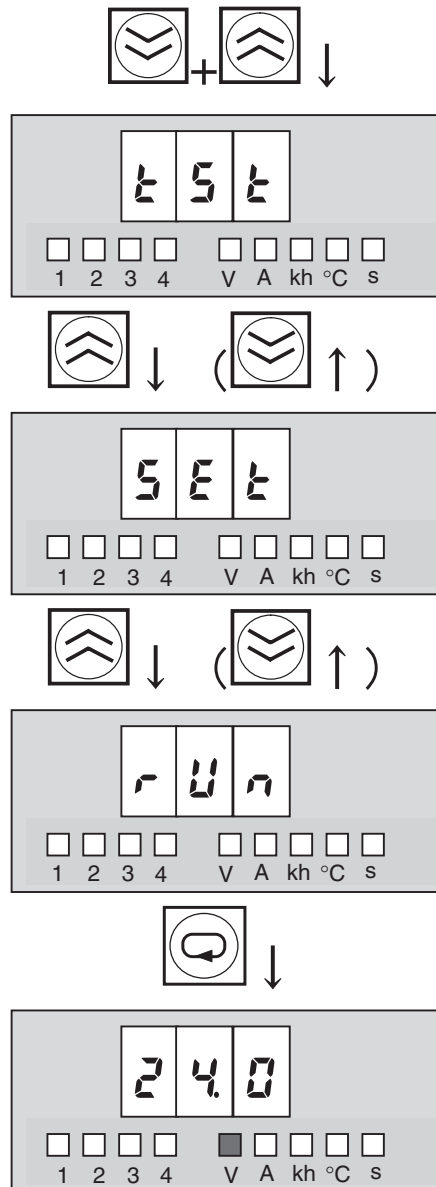

Press the Up Key (⏶) and Down Key (⏷) simultaneously for at least 3 s. The display will return to the Mode Selection Menu.

Press the Up Key (⏶) twice to display RUN and then press the Mode Key (↻) to change to Run Mode.

(If no keys are pressed within 5 s, the S8M will automatically return to the last operating mode.)

When Run Mode is entered, one of the following will be displayed: input voltage, current, run time, or internal temperature.

Operations in Run Mode

In Run Mode, the input voltage, the present current, and peak output current for branch outputs 1 to 4, the total current, the run time, and the internal temperature can be monitored regardless of the protection level. The peak output currents can also be cleared. The display can be changed in the order shown in the following table by pressing the Up Key (⏮) or Down Key (⏭).

Display	Output indicators				Unit indicators					Remarks
	1	2	3	4	V	A	kh	°C	s	
Input voltage	○	○	○	○	●	○	○	○	○	---
Present current of branch output 1	●	○	○	○	○	●	○	○	○	---
Peak output current of branch output 1 (See note.)	●	○	○	○	○	★	○	○	○	---
Present current of branch output 2	○	●	○	○	○	●	○	○	○	---
Peak output current of branch output 2	○	●	○	○	○	★	○	○	○	---
Present current of branch output 3	○	○	●	○	○	●	○	○	○	---
Peak output current of branch output 3	○	○	●	○	○	★	○	○	○	---
Present current of branch output 4	○	○	○	●	○	●	○	○	○	---
Peak output current of branch output 4	○	○	○	●	○	★	○	○	○	---
Total current of branch outputs 1 to 4	●	●	●	●	○	●	○	○	○	The total current for branch outputs 1 to 4 is displayed.
Run time	○	○	○	○	○	○	●	○	○	---
Internal temperature	○	○	○	○	○	○	○	●	○	---

- :Not lit
- :Lit
- ★ :Flashing

Note The procedure for clearing peak output currents is given next.

Clearing Peak Output Currents

The peak output currents can be cleared. Clearing is possible in any protection level. The procedure for clearing the peak output current for branch output 1 is given below.

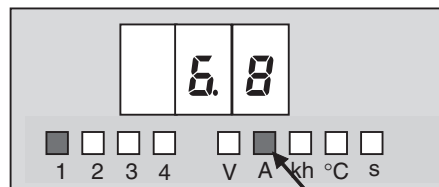

Press the Up Key (⏮) or Down Key (⏭) until the "A" unit indicator flashes.

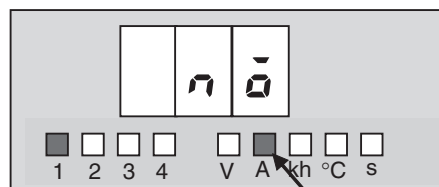

Press the Mode Key (⏻). "NO" will be displayed. Clearing is not possible from this display, so press the Up Key (⏮) to change the display to "YES."

(If no keys are pressed within 5 s, the S8M will automatically return to the last display.)

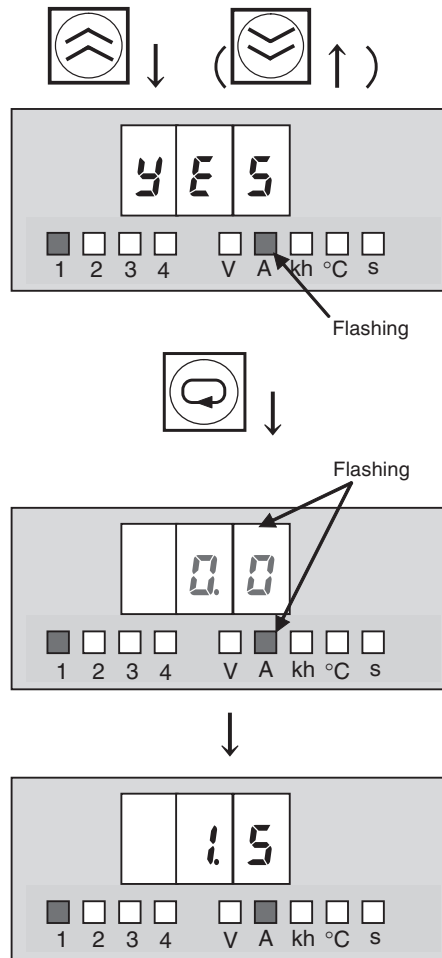

Press the Mode Key (⌚). Clearing the peak time will be started and 0.0 will flash on the display.

When 0.0 stops flashing, the clear process has been completed and the present current will be displayed as the peak output current.

- Note**
- (1) The S8M, however, contains a current-restricting circuit, so the peak value is not necessarily an accurate measure of the peak inrush current of the connected device.
 - (2) Due to the startup delay (page 24) the peak output current display value may be greater than the abnormal current tripping value.

SECTION 6

Support Tool

This section explains how to use the S8M Digital Multicircuit Protector's Support Tool.

6-1	Installing the Support Tool	82
6-2	Starting the Support Tool	85
6-3	Setting and Saving Parameters	87
6-4	Monitoring	92
6-5	Other Settings	96

6-1 Installing the Support Tool

The S8M Support Tool can be used to set parameters, monitor operating conditions, and manage parameter files in the S8M Digital Multicircuit Protector.

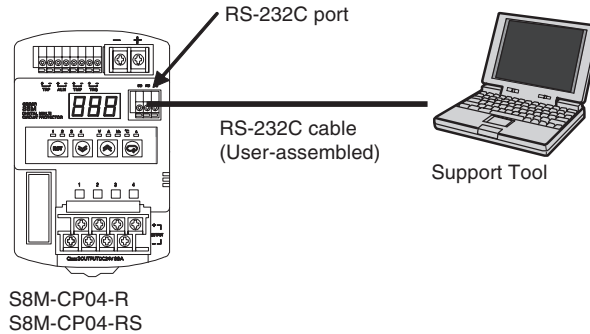

Compatible Models

The S8M Support Tool can be used with the S8M-CP04-R and S8M-CP04-RS. The S8M-CP04 is not equipped with a communications port, so the Support Tool cannot be used with the S8M-CP04.

The Support Tool can be used with Microsoft Windows 2000 or Windows XP.

Compatible models	S8M-CP04-R and S8M-CP04-RS
Incompatible models	S8M-CP04
Compatible operating systems	Microsoft Windows 2000 and Windows XP

Downloading the Support Tool

The S8M Support Tool can be downloaded from OMRON's website. The download is free.

Installing the Support Tool

- 1,2,3...
1. From the OMRON website, download the S8M_SUPPORT_TOOL-EN.exe and S8M_SUPPORT_TOOL-EN.msi files, move them to the desktop, and double-click the S8M_SUPPORT_TOOL-EN.exe file.

The installation method depends on the environment:

Environment other than .Net Framework 1.1:

Double-click S8M_SUPPORT_TOOL-EN.exe.

Net Framework 1.1 environment:

Double-click S8M_SUPPORT_TOOL-EN.msi.

When the S8M Support Tool has already been installed and you are installing again to repair or upgrade the software, use the Windows *Add/Remove Programs* function to uninstall the existing program before installing the new program.

It isn't necessary to uninstall .NET Framework 1.1.



Click the **OK** Button to start the installation.

2. Follow the menu directions and click the **Next** Button to complete the installation.

3. The following *Installation Complete* message will be displayed if the installation was completed normally. Click the **Close** Button.

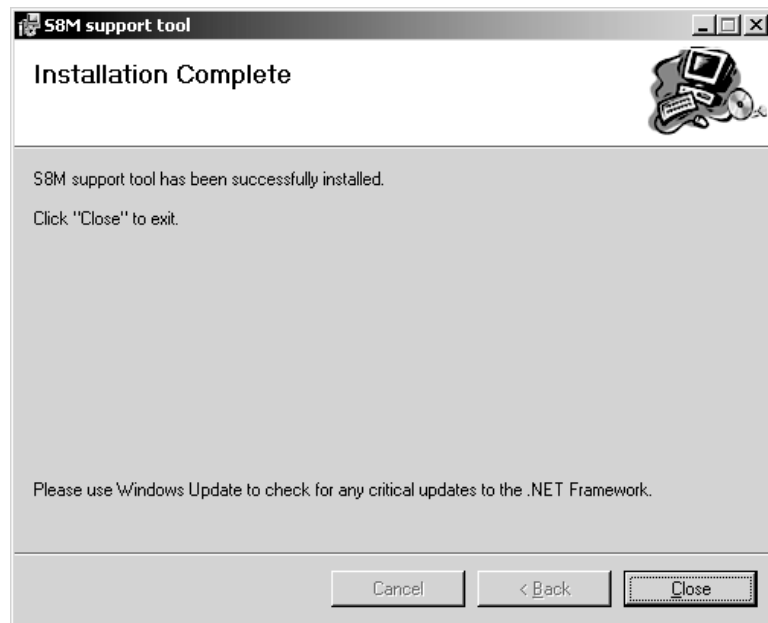

4. If the installation was completed normally, there will be an *OMRON* directory in the Programs Menu and an *S8M Support Tool* program in the *OMRON* directory.

6-2 Starting the Support Tool

To start the S8M Support Tool, select **Programs - OMRON - S8M Support Tool - S8M Support Tool** from the Start Menu.



When the Support Tool starts, it opens the Parameter Setting Window's Basic Settings Tab Page. The Parameter Setting Window is made up of the Basic Settings and Branch Output Settings Tab Pages, which can be selected by clicking the corresponding tab at the bottom of the page.

The operations in the Parameter Setting Window can be selected from the Menu Bar.

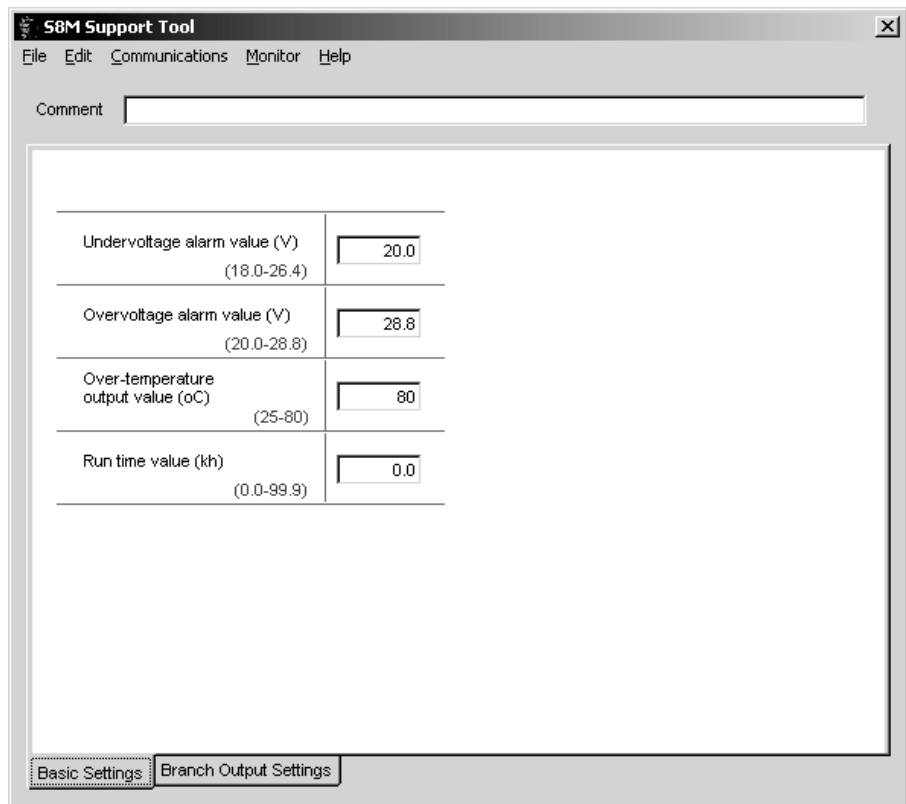

Menu Bar Items

The Support Tool settings and operations can be selected by opening the pull-down menus from the Menu Bar.

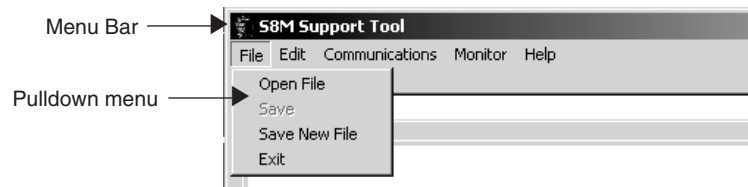

Menu item	Pulldown menu item	Description	
File	Open File	Opens a saved parameter file.	
	Save	Writes the parameters in a saved file. (Overwrites the file.)	
	Save New File	Saves the parameters in a file with a different file name.	
	Exit	Exits the Support Tool.	
Edit	Special Settings	Unit number, Baud rate, Data length, Stop bits, Parity, Send wait time	Sets the communications settings for the S8M's RS-232C port.
		Protect	Sets the protection level.
	Initialize	Returns all of the Support Tool parameters to their default values. This operation initializes the parameters in the computer, but does not change the S8M's parameter settings.	
Communica- tions	COM Port Settings	Unit number, Baud rate, Data length, Stop bits, Parity, Communications time-out	Sets the communications settings for the computer's RS-232C port.
	Upload	Reads the S8M's parameters to the Support Tool.	
	Download (See note 2.)	Transfers the edited parameters from the computer to the S8M.	
	Initialize Parameters	Initializes the S8M's parameters to their default values. (See note 1.)	
Monitor	Present Values	Reads the input voltage, each branch output's current and peak output current, the total current, internal temperature, and run time. Connection, disconnection, and reset operations can be executed.	
	Status	Reads the input voltage, each branch output's current, peak output current, total current, internal temperature, run time, external signal trips, and each branch output's power ON/OFF status. Reset operations can be executed.	
Help	Version	Displays the Support Tool's version number.	

- Note**
- (1) If the Initialize menu item is selected, all of the S8M's parameters will be reset to their default values. The operating mode will be switched to Setting Mode and all branch outputs will be disconnected.
 - (2) Initial power-ON processing is performed when the parameters are downloaded and the S8M will start in Run Mode. The edited parameters will be effective when the S8M restarts.
Immediately afterward, the software prompts the user to connect all branch outputs. If the **OK** Button is clicked, the cut-off branch outputs will be connected according to the pattern set with the startup sequence. (If branch outputs are already connected, they will be reconnected immediately after the download.)
 - (3) The *Comment* Field below the Menu Bar is used to enter a memo for file management in the Support Tool. The comment is not transferred to the S8M as a parameter, so the comment cannot be read when the parameters are uploaded.

6-3 Setting and Saving Parameters

The Parameter Setting Window appears when the Support Tool starts. The parameters can be set in this Window and the various functions can also be selected from the Menu Bar.

Setting the Parameters

There are two tab pages in the Parameter Setting Window: the Basic Settings Tab Page and Branch Output Settings Tab Page. Switch between these tab pages by clicking the corresponding tab at the bottom of the page and set the parameters in each tab page.

The parameters set in this window are just set in the Support Tool. The edited parameters must be downloaded to the S8M to change the S8M's parameters.

Basic Settings Tab Page (Window Displayed at Startup)

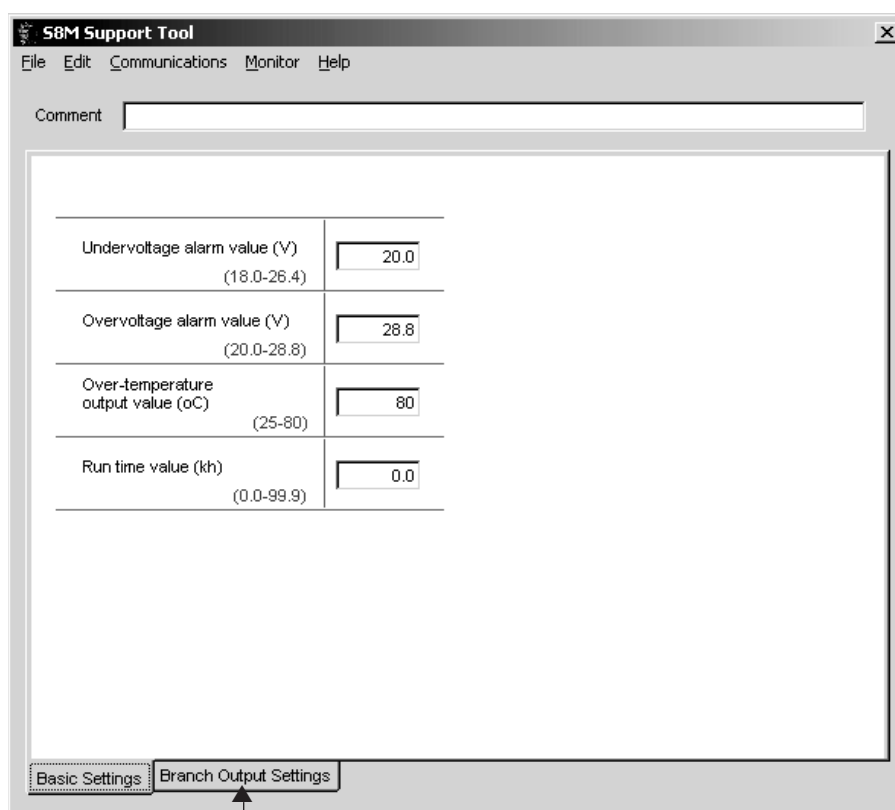

Click here to switch to the Branch Output Settings Tab Page.

Parameter	Settings		Reference page
	Setting range	Default value	
Undervoltage alarm value	18.0 to 26.4 V	20.0 V	27
Overvoltage alarm value	20.0 to 28.8 V	28.8 V	27
Over-temperature output value	25 to 80°C	80°C	28
Run time value	0.0 to 99.9 kh	0.0 kh (See note.)	30

Set the parameter under each heading. If a setting is outside of the allowed setting range, a warning message will be displayed and the setting will not be accepted.

Note The alarm will not be output when the alarm value is set to 0.0 kh.

**Branch Output Settings
Tab Page (Individual
Branch Output Settings)**

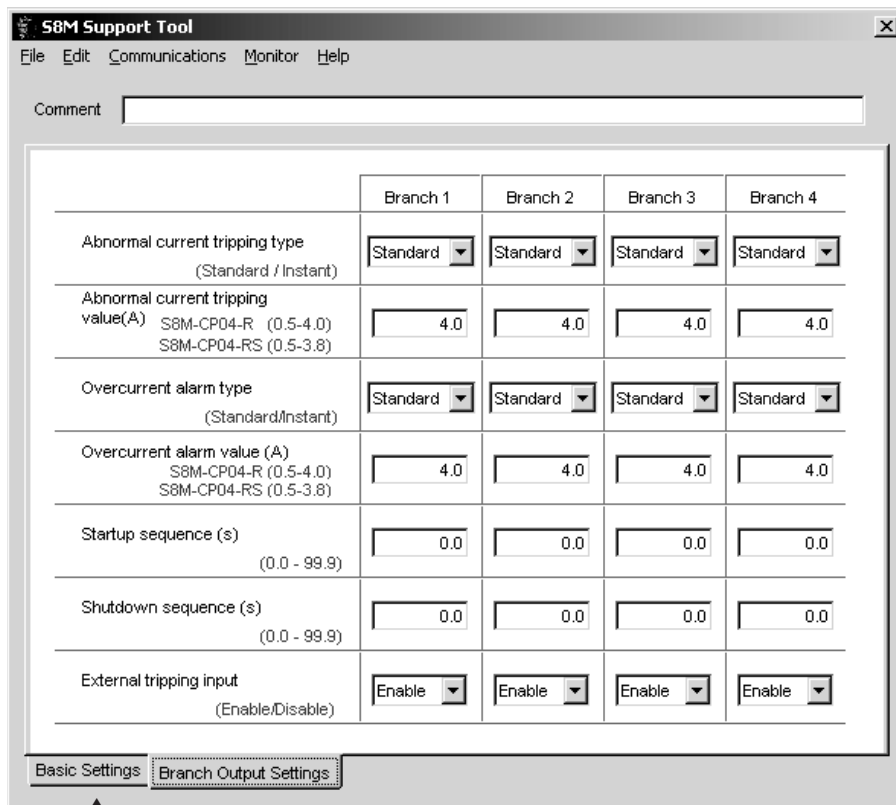

Click here to switch to the Basic Settings Tab Page.

Parameter		Settings		Reference page
		Setting range	Default value	
Abnormal current tripping type		Standard or instantaneous	Standard	22
Abnormal current tripping value	S8M-CP04-R	0.5 to 4.0 A	4.0 A	22
	S8M-CP04-RS	0.5 to 3.8 A	3.8 A	
Overcurrent alarm type		Standard or instantaneous	Standard	25
Overcurrent alarm value	S8M-CP04-R	0.5 to 4.0 A	4.0 A	25
	S8M-CP04-RS	0.5 to 3.8 A	3.8 A	
Startup sequence (See note 1.)		0 to 99.9 s	0.0 s	30
Shutdown sequence (See note 2.)		0 to 99.9 s	0.0 s	31
External tripping input (See note 3.)		Enable/Disable	Enable	4, 41

- Note**
- (1) The startup sequence can set delays from the point that the S8M's power is turned ON until power is supplied at each branch output.
 - (2) The shutdown sequence set delays from the point that the external tripping input goes ON until each branch output is cut off.
 - (3) The external signal input's tripping operation 2 can be enabled or disabled independently for each branch output.
 - (4) The setting ranges for the abnormal current tripping value and overcurrent alarm value are slightly different in the S8M models. If a value that is

out of range is set, it will be checked and rejected when the settings are downloaded.

- (5) If the parameters in the S8M-CP04-RS are initialized by selecting **Communication - Initialize Parameters**, the abnormal current tripping value and overcurrent alarm value will be set to 3.8 A. The same values on the computer are always set to 4.0 A when the parameters are initialized by selecting **Edit - Initialize** with the Support Tool, because the Support Tool does not distinguish between S8M models.

Saving the Parameters

This operation saves the edited parameters in a file. Select **File - Save New File** to save the file.

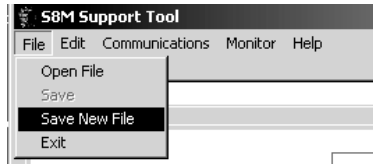

Note When a file is saved, a note such as the output's name can be entered in the Comment Field. The comment is not transferred to the S8M, so it is just used as a comment in the Support Tool itself.

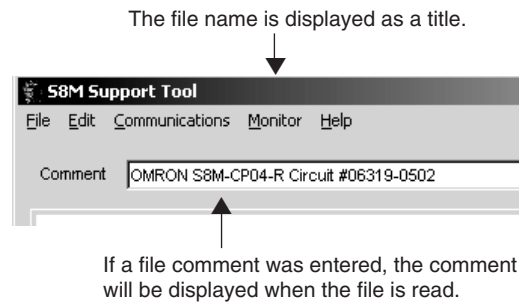

Downloading the Parameters

This operation writes the edited parameters from the Support Tool to the S8M.

- Connect to the computer with the RS-232C cable.

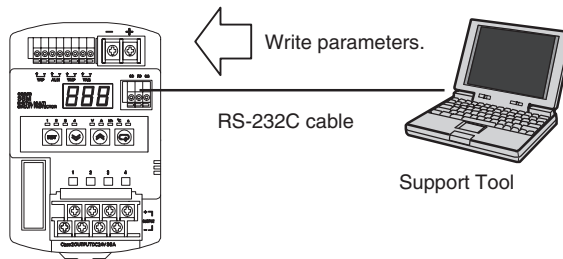

- 1,2,3... 1. Select **Communications - Download**.

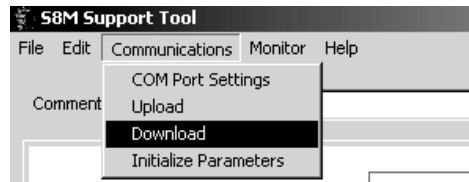

Note (1) Setting parameters in the Parameter Setting Window does not directly set or change the S8M parameters online, it sets the parameters offline in the

Support Tool. The download operation must be executed to write the parameters to the S8M.

- (2) When the parameters are downloaded, the S8M performs power-ON initialization and starts in Run Mode. Branch outputs that were connected will be reconnected according to the pattern set with the startup sequence and all of the new parameters will be effective at this time. Immediately afterward, the software prompts the user to connect all branch outputs. If the **OK** Button is clicked, the cut-off branch outputs will be connected according to the pattern set with the startup sequence.
 - (3) To read the parameters from the S8M, execute the Upload operation.
2. When **Download** is selected, the following popup window will open. If a window indicating a failure appears instead of this confirmation window, does not appear, check for a problem with the connection to the S8M or incorrect communications settings. Check the cable and communications settings. For details on checking the communications settings, refer to 6-5 *Other Settings*.

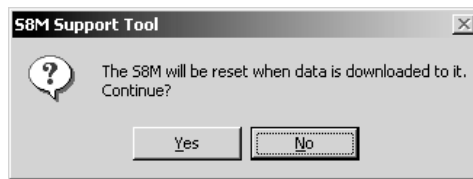

3. Click the **Yes** Button to start the download. If the parameters were written normally, the following popup window will be displayed prompting you to connect all of the branch outputs.

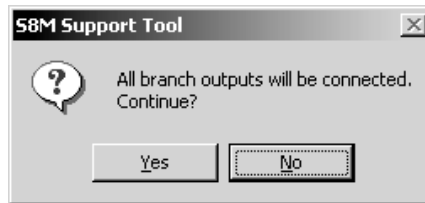

Click the **Yes** Button to start connecting. If a startup sequence has been set, the branch outputs will be connected according to the pattern set with the startup sequence.

4. If the outputs are connected after the download, the following popup window will be displayed to indicate that the download was completed successfully.



Click the **OK** Button.

- Note**
- (1) Parameters can be downloaded to the S8M when it is in Run Mode or Test Mode. The S8M's operating mode will not change after the download.
 - (2) If the communications settings are changed by downloading parameters, a communications error will occur when the S8M attempts to communicate after the **OK** Button is clicked at the *All branch outputs will be connected. Continue?* prompt. To prevent this error, click the **No** Button at the *All branch outputs will be connected. Continue?* prompt, change the computer COM port's settings to match the S8M's new communications settings, open the Present Value Window, and click the **Startup Sequence** Button to connect all of the branch outputs.
 - (3) The operating mode will change to Run Mode after the download.

Uploading the Parameters

This operation reads the S8M's parameters from the S8M to the Support Tool. Connect the S8M and computer with the RS-232C cable.

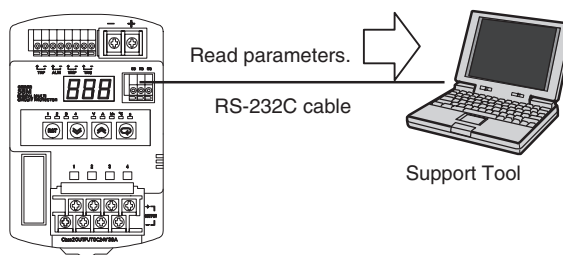

- 1,2,3... 1. Select **Communications - Upload**.

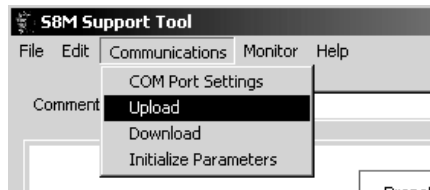

2. When **Upload** is selected, the following popup window will open.

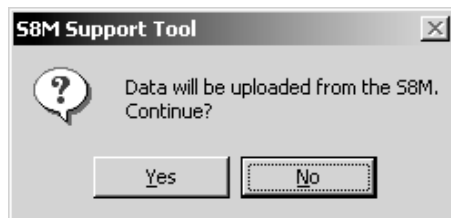

3. Click the **Yes** Button to start the upload. If the parameters were read normally, the following popup window will be displayed.



Click the **OK** Button.

Note The parameters can be uploaded regardless of the S8M's operating mode.

6-4 Monitoring

Use the Monitor operations to monitor the S8M's operating status.

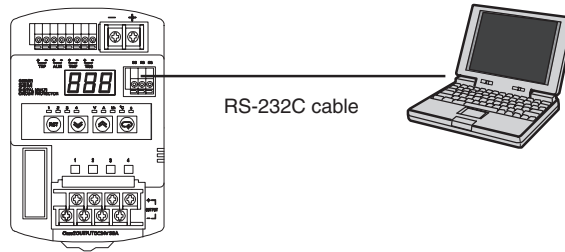

- 1,2,3... 1. Select **Monitor - Present Values** or **Monitor - Status**.

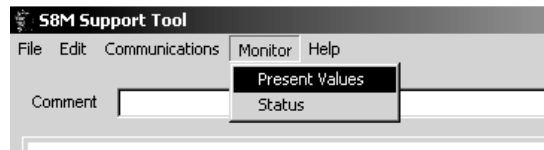

2. The following Monitor Update Interval Window will be opened when either monitor operation is selected. Set the sampling time in the *Update interval (s)* field.

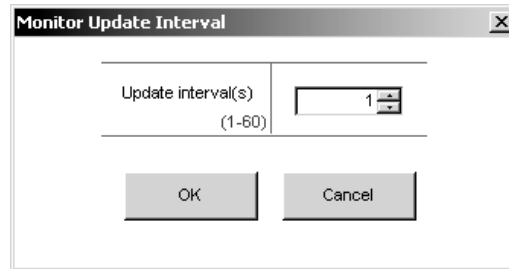

3. Enter the sampling time and click the **OK** Button to switch to the monitor window.

Monitoring Present Values

The screenshot shows a window titled "Present Values" with the following components:

- Input:** A field for "Input voltage (V)" displaying **24.1**.
- Outputs:** A table with columns for "Branch output current (A)", "Peak output current (A)", and "Peak output current clear". The current values are all **0.0**. The "Peak output current clear" column contains four "Clear" buttons, which are circled in red.
- Total current (A):** A field displaying **0.0**.
- Internal temperature (°C):** A field displaying **—**.
- Run time (kh):** A field displaying **0.0**.
- Current connection status:** A table with columns for "Branch output" (1, 2, 3, 4) and rows for "Connect" (status 0) and "Disconnect" (status x).
- Shunt output:** A table with columns for "Shunt output" (1, 2, 3, 4) and rows for "Connect" (status 0) and "Disconnect" (status x).
- Control Buttons:** A vertical stack of buttons: "Startup sequence", "Shutdown sequence", "Reset", "Monitor Status", and "Close".

Annotations on the right side of the window point to the following elements:

- Peak output current clear buttons (pointing to the circled "Clear" buttons)
- Connect output buttons (pointing to the "0" status in the "Connect" row of the "Shunt output" table)
- Disconnect output buttons (pointing to the "x" status in the "Disconnect" row of the "Shunt output" table)
- Startup Sequence Button (pointing to the "Startup sequence" button)
- Shutdown Sequence Button (pointing to the "Shutdown sequence" button)
- Reset Button (pointing to the "Reset" button)
- Close Button (pointing to the "Close" button)

Below the window, an arrow points to the "Monitor Status" button with the label "Monitor Status Button".

Window item		Description
Input voltage (V)		Displays the present input voltage.
Branch output	Branch output current (A)	Displays the present current being supplied at the branch output.
	Peak output current (A)	Displays the peak output current that was supplied at the branch output.
Total current (A)		Displays the total current being supplied to branch outputs 1 to 4.
Internal temperature (°C)		Displays the present internal temperature.

Window item	Description
Run time (kh)	Displays the run time. (The run time cannot be reset from the Support Tool.)
Current connection status	Displays the connection status. Green: Connected. White: Cut off by an operation or external signal. Red: Cut off due to an error. (The indicator will also be red when simultaneously cut off by an external operation.)

Button	Function
Peak output current clear	Clears the peak output current value.
Connect branch output	Connects the branch output. An output cannot be connected while the external tripping input is ON or there is an abnormal current or voltage.
Disconnect branch output	Disconnects the output.
Startup Sequence	Connects the branch outputs in the pattern set with the startup sequence settings.
Shutdown Sequence	Disconnects the branch outputs in the pattern set with the shutdown sequence settings.
Reset	Clears the output cutoff triggered by an abnormality or external tripping input, and reconnects the output. If the output was cut off by a Support Tool operation (shutdown sequence or output trip), the error will be reset, but the output will not be connected.
Monitor Status	Switches to the Status Window.
Close	Closes the Present Values Window.

Status Monitor

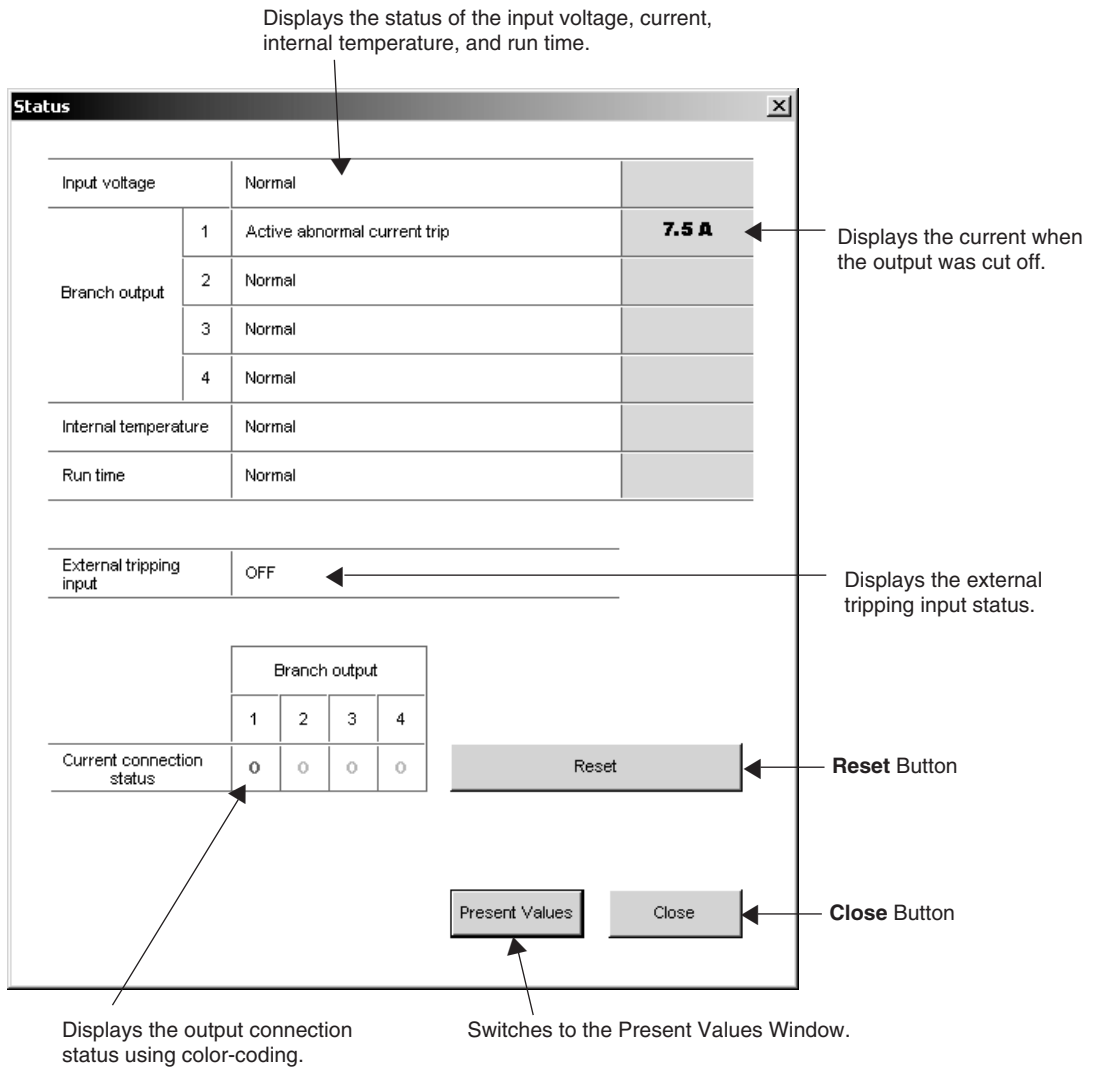

Window item	Description
Input voltage	The present values and set values are compared and the display indicates whether the present values are normal. If the value is abnormal, the display indicates the error and measured value.
Branch output	
Internal temperature	
Run time (See note.)	
External tripping input	Indicates whether or not the external trigger input (TRG) is ON.
Current connection status	Displays the connection status. Green: Connected. White: Cut off by an operation or external signal. Red: Cut off due to an error. (The indicator will also be red when simultaneously cut off by an external operation.)

Note The run time cannot be reset from the Support Tool.

Button	Function
Reset	Clears the error and supplies power at the branch output that was cut off.
Present Values	Switches to the Present Values Window.
Close	Closes the Status Window.

6-5 Other Settings

Communications Settings

These parameters set the communications settings for the computer's RS-232C port.

If an error message like the one below is displayed when you attempt to upload parameters, download parameters, or monitor operation, verify that the COM port settings match the S8M's communications settings.



Select **Communications - COM Port Settings**.

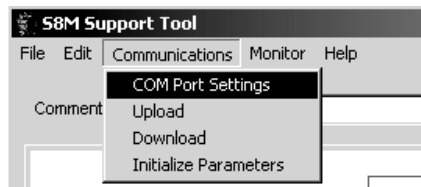

The Communication Settings Window will be displayed. Set each parameter as needed.

Set the port number to the computer's RS-232C port number.

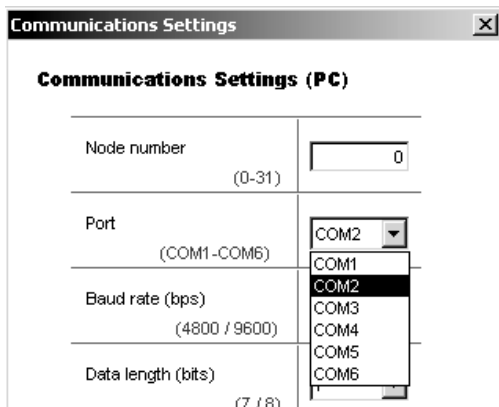

Setting the Protection Level

Select *Edit - Special Settings*.

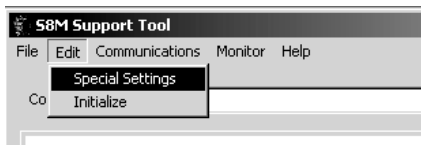

The Special Settings Window will be displayed. Set the protection level.

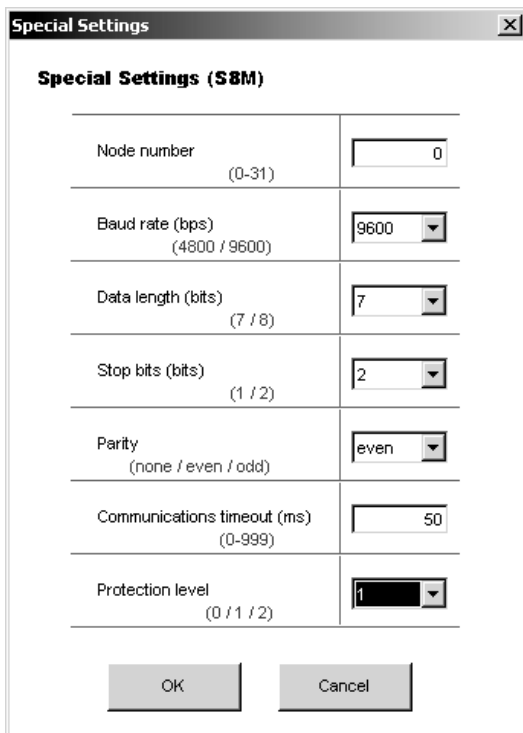

Refer to page 54 for details on protection levels.

The protection level setting will become effective after the download is completed, just like the other parameters.

Initializing the Support Tool's Parameters

When you want to initialize the parameters in the Support Tool, select **Edit - Initialize**.

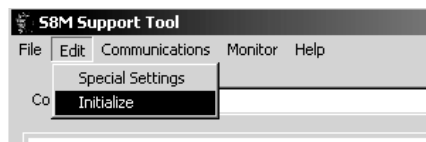

Note This operation does not directly initialize the S8M's parameters; it just initializes the parameters in the display windows.

Initializing the S8M's Parameters

1. When you want to initialize the parameters in the S8M, select **Communications - Initialize Parameters**.

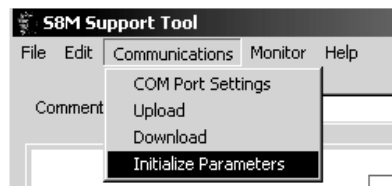

2. This operation writes the default values to the S8M's parameters. If the S8M's parameters were initialized properly, the following message will be displayed.

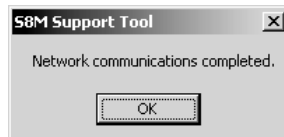

3. The following operations are performed when the S8M's parameters are initialized.

- The operating mode is changed to Setting Mode.
- Each parameter is changed to its default value.
- Each branch output is disconnected.
- The protection level is changed to level 1.

Reading the Version

1. The S8M Support Tool's version number can be read. Select **Help - Version**.



2. The Support Tool's version number will be displayed.



Version number

SECTION 7

Communications

This section describes the communications provided by the S8M.

7-1	CompoWay/F Communications Specifications	100
7-2	Frame Structure.....	101
7-2-1	Command Frame Structure.....	101
7-2-2	Response Frame Structure	102
7-2-3	FINS-mini Structure	105
7-3	Details of Services	109
7-4	Read Controller Information.....	112
7-5	Read Controller Attributes	114
7-6	Read Controller Status	115
7-7	Echoback Test.....	116
7-8	Operation Command.....	117
7-9	Response Code List.....	118
7-10	ASCII List.....	119

7-1 CompoWay/F Communications Specifications

The S8M-CP04-R and S8M-CP04-RS are equipped with RS-232C ports, which allow remote monitoring and remote operations over the network such as setting parameters, supplying power from outputs, cutting off outputs, and resetting the run time.

Connecting to the Network

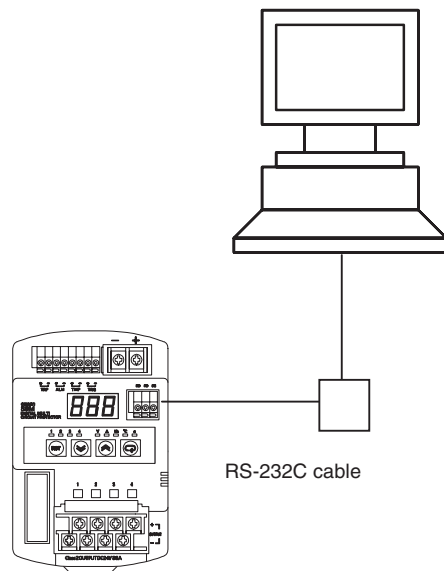

Refer to *3-4 RS-232C Port Wiring (S8M-CP04-R and S8M-CP04-RS Only)* for details on assembling and connecting a RS-232C cable.

Communications Specifications

Connection configuration	1:1 connection
Communications method	RS-232C
Synchronization method	Start-stop synchronization
Baud rate	4,800 or 9,600 bps (Default value: 9,600 bps)
Transmission code	ASCII
Data length	7 or 8 bits (Default value: 7 bits)
Stop bits	1 or 2 bits (Default value: 2 bits)
Error detection	Vertical parity: None, even, or odd (Default value: Even) BCC (block check character)
Flow control	None
Retry function	None
Communications buffer	64 bytes

Communications Control Method

Programs are created in the host computer to set or monitor parameters in the S8M, so the descriptions in this section are from the standpoint of the host computer.

CompoWay/F is OMRON's unified communications protocol for general-purpose serial communications. This unified format has a proven track record with OMRON Programmable Controllers, has FINS-compliant commands (see note), and simplifies communications between the host computer and components.

Note FINS (Factory Interface Network service) is a messaging protocol for communications between Controllers in OMRON FA networks.

The S8M has the following communications functions:

- Reading settings and data
- Executing operation commands
- Switching setting levels

The following restriction applies to the communications functions:

- Settings data can be written only when writing is allowed through communications.

7-2 Frame Structure

7-2-1 Command Frame Structure

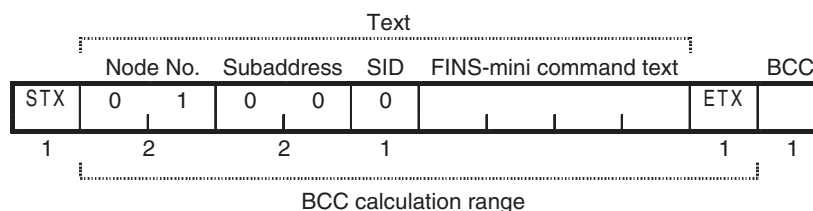

STX	This code, 02 hex, indicates the beginning of a communications frame (text). This code must always be set as the first byte. When another STX code is received during reception, the reception starts again from the point where the STX was received.
Node No. (Node address)	<ul style="list-style-type: none"> • The node address identifies the destination node. • The node address can be set to 00 to 32. • There will be no response to a transmission with an invalid node address.
Subaddress	The subaddress is not used in the S8M. Always set the subaddress to "00."
SID (Service ID)	The SID is not used in the S8M. Always set the SID to "0."
Command text	The command and required text are placed here. Refer to 7-2-3 FINS-mini Structure for details.
ETX	This code, 03 hex, indicates the end of text.
BCC	This is the block check character. The BCC is calculated by taking the exclusive OR of all bytes from the node number to the ETX.

7-2-2 Response Frame Structure

■ Normal Response

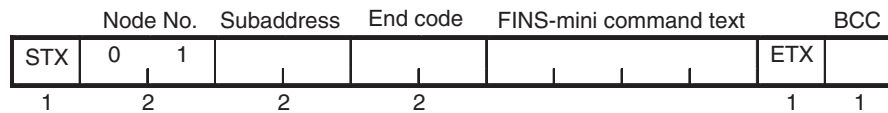

■ Response if Specified FINS Command was not Executed

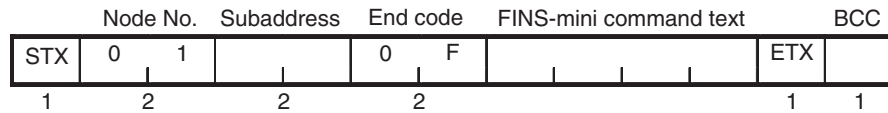

■ Response for Command Frame Error

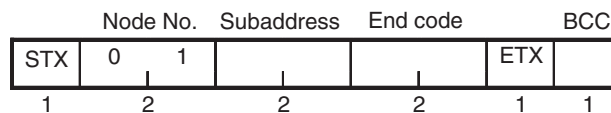

■ End Codes

End code	Name	Meaning	Error priority
00	Normal end	The command frame was processed normally without any of the following errors.	None
0F	FINS command error	The specified FINS command could not be executed. Refer to the response code for more details.	7
10	Parity error	A parity error was detected in the received data because the parity bit in the data did not match the parity setting.	1
11	Framing error	The stop bit was "0."	2
12	Overrun error	Attempted to write new data to the reception register when the reception register was full.	3
13	BCC error	The received BCC did not match the calculated BCC.	4
14	Format error	There was an illegal character in the FINS-mini frame (character other than ASCII 0 to 9 or A to F) or data other than the test data was returned in response to an Echoback Test. There were no SID and FINS-mini. There was no FINS-mini. The FINS-mini MRC and SRC were incorrect.	6
16	Subaddress error	The subaddress was invalid (unsupported). There were no subaddress, SID, and FINS-mini. The subaddress was shorter than 2 characters and there were no SID and FINS-mini.	5

- An end code is returned for each received command frame addressed to the local node.
- No response will be returned if the message is not complete through the ETX and BCC characters.
- The error priority indicates the priority of the error notification when there were two or more errors.

End Code Examples The following examples show some errors and corresponding end codes.

Missing Subaddress, SID, and FINS-mini

■ **Command**

Node No.		BCC	
STX	0 1	ETX	

■ **Response**

Node No.		Subaddress		End code		BCC	
STX	0 1	0 0	1 6	ETX			

The subaddress is 00 and the end code is 16 (subaddress error).

Subaddress Less than 2 Characters, Missing SID and FINS-mini

■ **Command**

Node No.		BCC	
STX	0 1 0	ETX	

The subaddress is missing one character.

■ **Response**

Node No.		Subaddress		End code		BCC	
STX	0 1	0 0	1 6	ETX			

The subaddress is 00 and the end code is 16 (subaddress error).

Subaddress Normal, Missing SID and FINS-mini

■ **Command**

Node No.		Subaddress		BCC	
STX	0 1	0 0	ETX		

■ **Response**

Node No.		Subaddress		End code		BCC	
STX	0 1	0 0	1 4	ETX			

The end code is 14 (format error).

Subaddress Invalid, Missing SID and FINS-mini

■ **Command**

Node No.		Subaddress		BCC	
STX	0 1	0 A	ETX		

■ **Response**

Node No.		Subaddress		End code		BCC	
STX	0 1	0 0	1 6	ETX			

The end code is 16 (subaddress error). The subaddress error code is returned because the subaddress was received and the subaddress error has a higher error priority than the format error.

Missing FINS-mini

■ Command

	Node No.		Subaddress		SID	BCC	
STX	0	1	0	0	0	ETX	

■ Response

	Node No.		Subaddress		End code		BCC	
STX	0	1	0	0	1	4	ETX	

The end code is 14 (format error).

Incomplete MRC and SRC Codes in FINS-mini

■ Command

	Node No.		Subaddress		SID	FINS-mini		BCC	
STX	0	1	0	0	0	MRC	0	ETX	

The SRC is missing one character.

■ Response

	Node No.		Subaddress		End code		BCC	
STX	0	1	0	0	1	4	ETX	

The end code is 14 (format error).

Incomplete Node Address

■ Command

	Node No.		BCC	
STX		ETX		

The node address is missing one character.

■ Response

None (There is no response because the return node address is unknown.)

Missing Subaddress, Invalid BCC

■ Command

	Node No.		BCC	
STX	0	1	ETX	Err

■ Response

	Node No.		Subaddress		End code		BCC	
STX	0	1	0	0	1	3	ETX	

The subaddress is 00 and the end code is 13 (BCC error).

Invalid Subaddress and BCC

■ Command

	Node No.		Subaddress		BCC	
STX	0	1	0	A	ETX	Err

■ Response

	Node No.		Subaddress		End code		BCC	
STX	0	1	0	0	1	3	ETX	

The end code is 13 (BCC error).

There was a subaddress error, but the BCC error has a higher error priority.

7-2-3 FINS-mini Structure

PDU Structure

The MRC (Main Request Code), SRC (Sub-Request Code), and any required data are transmitted in the command frame.

■ Service Request PDU

MRC	SRC	Data	
-----	-----	------	--

The MRC and SRC shown above, MRES (Main Response Code), SRES (Sub-Response Code), and the response data are transmitted in the response frame.

■ Service Response PDU (Normal Response)

MRC	SRC	MRES	SRES	Data	
-----	-----	------	------	------	--

If the specified FINS-mini command could not be executed, service response PDU will contain only the MRC/SRC and MRES/SRES.

■ Service Response PDU (Specified FINS-mini Command Not Executed)

MRC	SRC	MRES	SRES
-----	-----	------	------

The MRES and SRES become the response code when the command was not completed normally.

Type Code
(Variable Type)

The following table shows the variable area type codes.

Variable type	R/W	Size	Contents
80	R	Word	Monitored values, Alarm status, Unpublished information
81	R/W	Word	Setting and checking set values

Addresses

Monitored Values

■ Variable Type 80

Address	Name	Data range
0000	Present input voltage	00A3 to 012C (16.3 to 30.0 V)
0001	Total current	0000 to 0190 (0.0 to 40.0 A)
0002	Run time	0000 to 03E7 (0 to 999 kh)
0003	Internal temperature	FFEC to 0064 (-20 to 100°C)

Address	Name	Data range
0010	Present current, branch output 1	0000 to 0064 (0.0 to 10.0 A)
0011	Present current, branch output 2	
0012	Present current, branch output 3	
0013	Present current, branch output 4	
0020	Peak output current, branch output 1	0000 to 0064 (0.0 to 10.0 A)
0021	Peak output current, branch output 2	
0022	Peak output current, branch output 3	
0023	Peak output current, branch output 4	

Note If the upper limit of the displayable range is exceeded, the upper limit will be displayed. If the lower limit is exceeded, the lower limit will be displayed.

Alarm Status

The alarm status is used to read the controller status.

Alarm Cause

■ Variable Type 80

Address	Name	Data range
1000	Voltage when abnormal voltage tripping occurred	00A3 to 012C (16.3 to 30.0 V)
1001	Maximum voltage after overvoltage alarm occurred	00A3 to 012C (16.3 to 30.0 V)
1002	Minimum voltage after undervoltage alarm occurred	00A3 to 012C (16.3 to 30.0 V)

Note The run time and temperature are represented by variables 0002 and 0003, respectively.

Address	Name	Data range
1010	Current when abnormal current tripping occurred in branch output 1 (Redundant abnormal current tripping for the S8M-CP04-RS only)	0000 to 0064 (0.0 to 10.0 A)
1011	Current when abnormal current tripping occurred in branch output 2 (Redundant abnormal current tripping for the S8M-CP04-RS only)	
1012	Current when abnormal current tripping occurred in branch output 3 (Redundant abnormal current tripping for the S8M-CP04-RS only)	
1013	Current when abnormal current tripping occurred in branch output 4 (Redundant abnormal current tripping for the S8M-CP04-RS only)	

Address	Name	Data range
1020	Current when abnormal current tripping occurred in branch output 1	0000 to 0064 (0.0 to 10.0 A)
1021	Current when abnormal current tripping occurred in branch output 2	
1022	Current when abnormal current tripping occurred in branch output 3	
1023	Current when abnormal current tripping occurred in branch output 4	

Address	Name	Data range
1030	Current when overcurrent alarm occurred in branch output 1	0000 to 0064 (0.0 to 10.0 A)
1031	Current when overcurrent alarm occurred in branch output 2	
1032	Current when overcurrent alarm occurred in branch output 3	
1033	Current when overcurrent alarm occurred in branch output 4	

Note If the upper limit of the displayable range is exceeded, the upper limit will be displayed. If the lower limit is exceeded, the lower limit will be displayed.

Parameters

■ Variable Type 81

Address	Name	Data range
0000	Undervoltage alarm value	00B4 to 0108 (18.0 to 26.4 V)
0001	Overvoltage alarm value	00C8 to 0120 (20.0 to 28.8 V)
0002	Over-temperature output value	0019 to 0050 (25 to 80°C)
0003	Run time value	0001 to 03E7 (1 to 99.9 kh)
0004	Protection level	0000 to 0002 (0: R/W allowed; 1: Limited R/W; 2: Limited read-only)

Address	Name	Data range
0010	Current tripping type for branch output 1	0000 or 0001 (0: Standard; 1: Instantaneous)
0011	Current tripping type for branch output 2	
0012	Current tripping type for branch output 3	
0013	Current tripping type for branch output 4	

Address	Name	Data range
0020	Current tripping value for branch output 1	0005 to 0028 (0.5 to 4.0 A) UL Class 2 output model: 0005 to 0026 (0.5 to 3.8 A)
0021	Current tripping value for branch output 2	
0022	Current tripping value for branch output 3	
0023	Current tripping value for branch output 4	

Address	Name	Data range
0030	Overcurrent alarm type for branch output 1	0000 or 0001 (0: Standard; 1: Instantaneous)
0031	Overcurrent alarm type for branch output 2	
0032	Overcurrent alarm type for branch output 3	
0033	Overcurrent alarm type for branch output 4	

Address	Name	Data range
0040	Overcurrent alarm value for branch output 1	0005 to 0028 (0.5 to 4.0 A) UL Class 2 output model: 0005 to 0026 (0.5 to 3.8 A)
0041	Overcurrent alarm value for branch output 2	
0042	Overcurrent alarm value for branch output 3	
0043	Overcurrent alarm value for branch output 4	

Address	Name	Data range
0050	Startup sequence for branch output 1	0000 to 03E7 (0: Disabled, or 0.1 to 99.9 s)
0051	Startup sequence for branch output 2	
0052	Startup sequence for branch output 3	
0053	Startup sequence for branch output 4	

Address	Name	Data range
0060	Shutdown sequence for branch output 1	0000 to 03E7 (0: Disabled, or 0.1 to 99.9 s)
0061	Shutdown sequence for branch output 2	
0062	Shutdown sequence for branch output 3	
0063	Shutdown sequence for branch output 4	

Address	Name	Data range
0070	External tripping input cutoff for branch output 1	0000 or 0001 (0: Enabled; 1: Disabled)
0071	External tripping input cutoff for branch output 2	
0072	External tripping input cutoff for branch output 3	
0073	External tripping input cutoff for branch output 4	

Number of Elements

The number of elements is expressed in 2-byte hexadecimal. There are relatively few variables in the S8M and the setting range for the number of elements is 0 to 13 so that all of the monitored values can be accessed together.

List of Services

MRC	SRC	Name of service	Processing
01	01	Read Variable Area	This service reads from variable areas.
01	02	Write Variable Area	This service writes to variable areas.
05	03	Read Controller Attributes	This service reads the model number and communications buffer size.
06	01	Read Controller Status	This service reads the operating status.
08	01	Echoback Test	This service performs an echoback test.
30	05	Operation Command	This service performs operations such as reset.

Note No commands (services) will be accepted and no responses will be returned when a memory error (RAM error) has occurred.

7-3 Details of Services

Read Variable Area

This service reads data from a variable area.

■ **Service Request PDU**

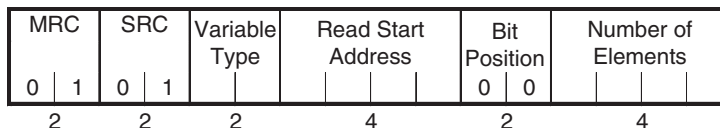

■ **Service Response PDU**

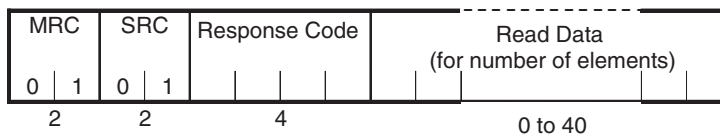

(1) **Variable Type and Read Start Address**

The definitions are different for each product.

(2) **Bit Position**

The S8M does not support bit access. Fixed to "00."

(3) Number of Elements

Number of elements	Processing
0000	The read operation is not performed (read data is not appended to the service response PDU), and processing ends in “normal completion.”
0001 to 000A	The read operation is performed, and processing ends in “normal completion” (hexadecimal display).

- Note**
- (1) If the Read Start Address is outside of the variable area, the returned read data will all be 0, but the specified number of elements will be returned and the processing will end in “normal completion.”
 - (2) If the Read Start Address is within the variable area and the Read End Address (Read Start Address + Number of Elements) is beyond the last variable area address, the read operation will be performed as long as the amount of data up to the last variable area address is within the specified range of the number of elements. The read data beyond the end of the variable area will all be set to 0. (See the following example.)

Reading Two Elements and Exceeding the Last Variable Area Address

In this case, the second element does not exist, so the read data will be AAAA0000.



■ **Response Codes**

Response code	Error name	Cause	Error priority
1001	Command too long	The command is too long.	1
1002	Command too short	The command is too short.	2
1101	Area type error	The variable type is incorrect.	3
110B	Response too long	The number of elements is larger than “000A.”	4
1100	Parameter error	The bit position is not “00.”	5
0000	Normal completion	No error	None

Write Variable Area

This service writes data to a variable area.

■ **Service Request PDU**

MRC	SRC	Variable Type	Write Start Address	Bit Position	Number of Elements	Write Data
0 1	0 2			0 0		
2	2	2	4	2	4	0 to 40

■ Service Response PDU

MRC	SRC	Response Code			
0 1	0 2				
2	2	4			

(1) Variable Type and Write Start Address

The definitions are different for each product.

(2) Bit Position

The S8M does not support bit access. Fixed to "00."

(3) Number of Elements

Number of elements	Processing
0000	The write operation is not performed (does not append write data to the service request PDU) and processing ends in "normal completion."
0001 to 000A	The write operation is performed and processing ends in "normal completion" (hexadecimal display).

3. Response Codes

Response code	Error name	Cause	Error priority
1002	Command too short	The command is too short.	1
1101	Area type error	The variable type is incorrect.	2
1003	Number of elements/data mismatch	The amount of data does not match the number of elements.	3
1100	Parameter error	The bit position is not "00." The write data is out of the setting range.	4
0000	Normal completion	No error	None

Note The "command too long" error does not occur with the Write Variable Area command.

If data is written up to the number of elements specified in the service request, the error is processed as a number of elements/data mismatch error.

If the Write Start Address is outside of the variable area, the write operation will not be performed, but the processing will end in "normal completion." The same thing will happen if the Write End Address is outside of the variable area. (See the following examples.)

- In this case, the number of elements (2) is within the specified range, but the Write Start Address setting is incorrect.

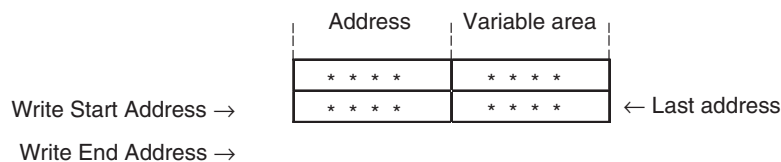

- In this case, the Write Start Address setting is correct, but the number of elements (3) exceeds the specified range.

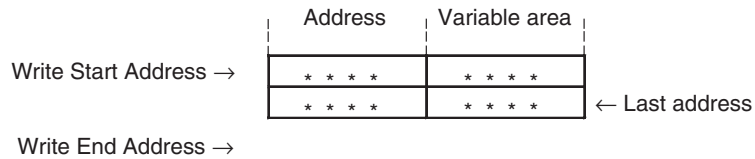

Note The system checks whether the number of elements is within the specified range when it performs the number of elements/data mismatch check. (See the following examples.)

Number of Elements/Data Mismatch

A number of elements/data mismatch error will occur in the following situations.

The data will not be written when this error occurs.

- In this case, the Write Start Address setting is correct and the amount of write data (2) is within the specified range, but the number of elements (4) exceeds the specified range.



- In this case, the number of elements (2) and the amount of write data (1) are both within the specified range, but the two values do not match.



When the number of elements is 2 and the amount of write data is 2, but second value (amount of write data) is outside of the setting range, the data will be written from the Start Write Address and a parameter error will occur when the system attempts to write the parameter that is outside of the setting range.

7-4 Read Controller Information

This service reads the Controller's model and version.

■ Service Request PDU

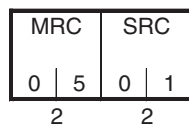

■ Service Response PDU

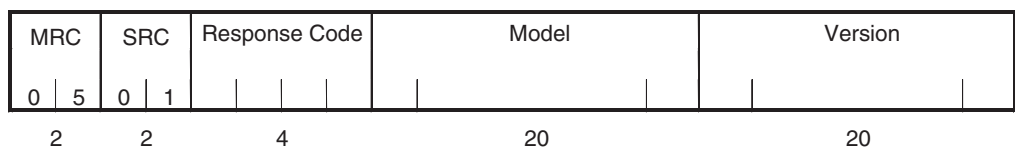

(1) Model

The S8M's model number is returned in 20 bytes of ASCII data. If the data is less than 20 bytes long, the remaining bytes will be padded with spaces (20 hex).

The following table shows the model number format.

Model	Code (4 bytes)
Same in all models	S8M
Input voltage	Code (1 byte)
5 V	0
12 V	1
24 V	2
Number of branch outputs	Code (1 byte)
1	1
2	2
3	3
4	4
Communications specification	Code (1 byte)
RS-232C	0
NEWS	1 (fixed)
UL Class 2 output	Code (1 byte)
No	0
Yes	1
Reserved 1	Code (1 byte)
---	0
Reserved 2	Code (1 byte)
---	0
Remaining bytes	(10 bytes)
---	All spaces

(2) Version

The version is returned in 20 bytes of ASCII data. If the data is less than 20 bytes long, the remaining bytes will be padded with spaces (20 hex).

Example: "V1.00"

The remaining 15 bytes are all spaces.

(3) Response Code

Response code	Error name	Cause	Error priority
1001	Command too long	The command is too long.	1
0000	Normal completion	No error	0

7-5 Read Controller Attributes

This service reads the model number and communications buffer size.

■ Service Request PDU

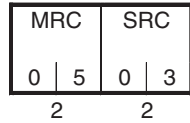

■ Service Response PDU

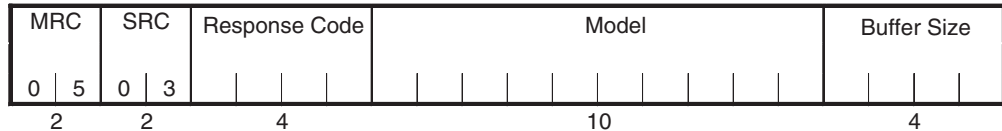

(1) Model

The first 10 bytes of ASCII data from the Read Controller Information command are returned. A specifications code follows the model number.

The following table shows the model number format.

Model	Code (4 bytes)
Same in all models	S8M-
Input voltage	Code (1 byte)
5 V	0
12 V	1
24 V	2
Number of branch outputs	Code (1 byte)
1	1
2	2
3	3
4	4
Communications specification	Code (1 byte)
RS-232C	0
NEWS	1 (fixed)
UL Class 2 output	Code (1 byte)
No	0
Yes	1
Reserved 1	Code (1 byte)
---	0
Reserved 2	Code (1 byte)
---	0

(2) Buffer Size

The communications buffer size is expressed in 2-byte hexadecimal and is converted to 4-byte ASCII before being displayed.

0040 (Indicates 64 bytes.)

(3) Response Code

Response code	Error name	Cause	Error priority
1001	Command too long	The command is too long.	1
0000	Normal completion	No error	0

7-6 Read Controller Status

This service reads the operating status and error status.

■ Service Request PDU

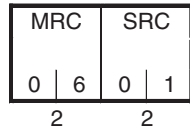

■ Service Response PDU

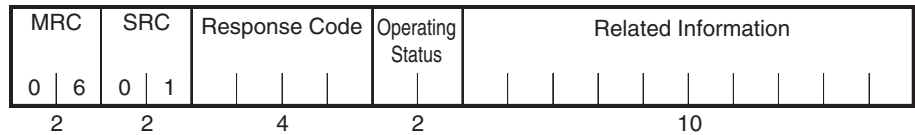

(1) Operating Status

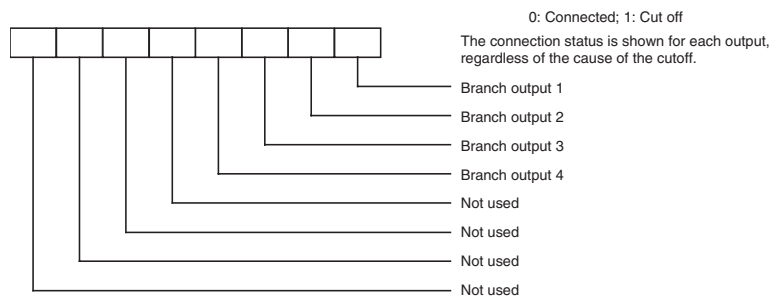

“00” or shows the connection/disconnection status listed below.

(2) Related Information

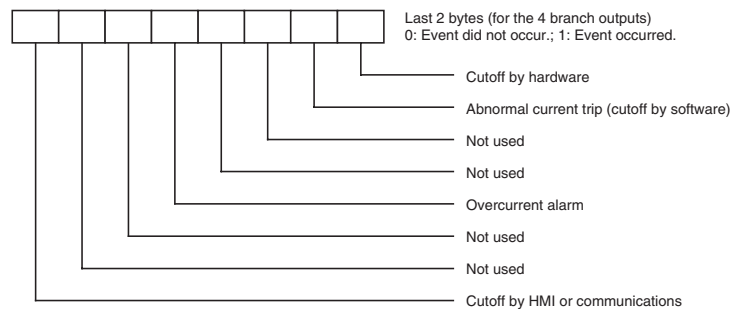
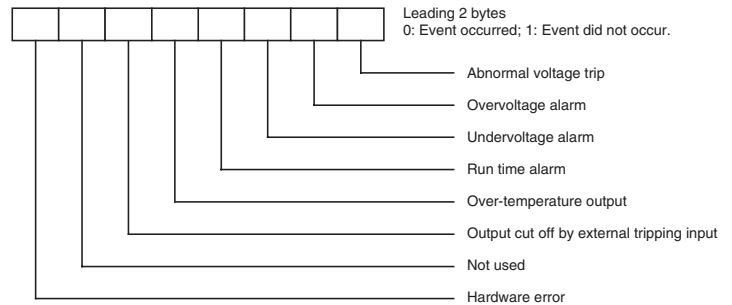

(3) Response Codes

Response code	Error name	Cause	Error priority
1001	Command too long	The command is too long.	1
0000	Normal completion	No error	0

7-7 Echoback Test

This service performs an echoback test.

■ **Service Request PDU**

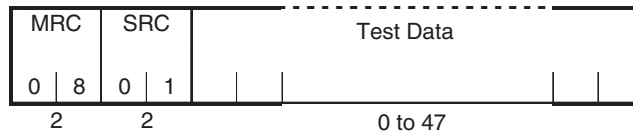

■ **Service Response PDU**

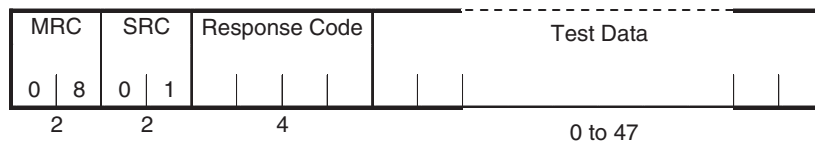

(1) Test Data

Set values for the test data within the ranges shown below, depending on the communications data length setting.

Data length	Processing
8 bits	ASCII data: 20 to 7E or A1 to FE
7 bits	ASCII data: 20 to 7E

(2) Response Codes

Response code	Error name	Cause	Error priority
1001	Command too long	The command is too long.	1
0000	Normal completion	No error	0

7-8 Operation Command

This service performs operation command processing.

■ Service Request PDU

MRC	SRC	Command Code	Related Info.
3 0	0 5		
2	2	2	2

■ Service Response PDU

MRC	SRC	Response Code
3 0	0 5	
2	2	4

(1) Command Codes and Related Information

Command code	Command content	Related Information
00	Connect	Each bit corresponds to a branch output. (Multiple branch outputs can be specified.) 01: Branch output 1 02: Branch output 2 04: Branch output 3 08: Branch output 4
01	Disconnect (Cut off)	Each bit corresponds to a branch output. (Multiple branch outputs can be specified.) 01: Branch output 1 02: Branch output 2 04: Branch output 3 08: Branch output 4
02	Startup sequence	Always set to 00.
03	Shutdown sequence	Always set to 00.
04	Reset switch	Always set to 00.
10	Clear peak output current	Each bit corresponds to a branch output. (Multiple branch outputs can be specified.) 01: Branch output 1 02: Branch output 2 04: Branch output 3 08: Branch output 4
11	Clear run time	Always set to 00.

Note When a command is executed for all of the outputs, but the processing could not be performed on one or more outputs, the processing will still be performed on the other outputs. In this case, a normal response will be returned, so read the controller status to check whether or not the outputs were actually connected/cut off.

(2) Response Codes

Response code	Error name	Cause	Error priority
1001	Command too long	The command is too long.	1
1002	Command too short	The command is too short.	2
1100	Parameter error	Command code and related information are wrong. Bit is ON for a non-existent branch output.	3
2203	Operation error	Processing could not be performed. (See note.)	4
0000	Normal completion	No error	0

Note Includes execution within 15 seconds after the last reset switch request.

7-9 Response Code List

Response code	Error name	Cause	Error priority
0000	Normal completion	No error	
0401	Unsupported command	The service function for the specified command is not supported.	1
1001	Command too long	The command is too long.	2
1002	Command too short	The command is too short.	3
1101	Area type error	The variable type is incorrect.	4
1003	Number of elements/ data mismatch	The amount of data does not match the number of elements.	5
100B	Response too long	The response exceeds the communications buffer size.	6
1100	Parameter error	<ul style="list-style-type: none"> • The bit position is not 00. • A fixed 00 value was not set to 00. • Incorrect command code or related information in the operation command. • Incorrect operating mode or related information in a change operating mode command. • The write data is out of the setting range. 	7
3003	Read-only error	Attempted to write a read-only variable.	8
2203	Operation error	<ul style="list-style-type: none"> • The operation command could not be processed. • Not moved to system search mode. • A non-volatile memory error occurred. • Executed within 15 seconds after the last reset operation. 	9

7-10 ASCII List

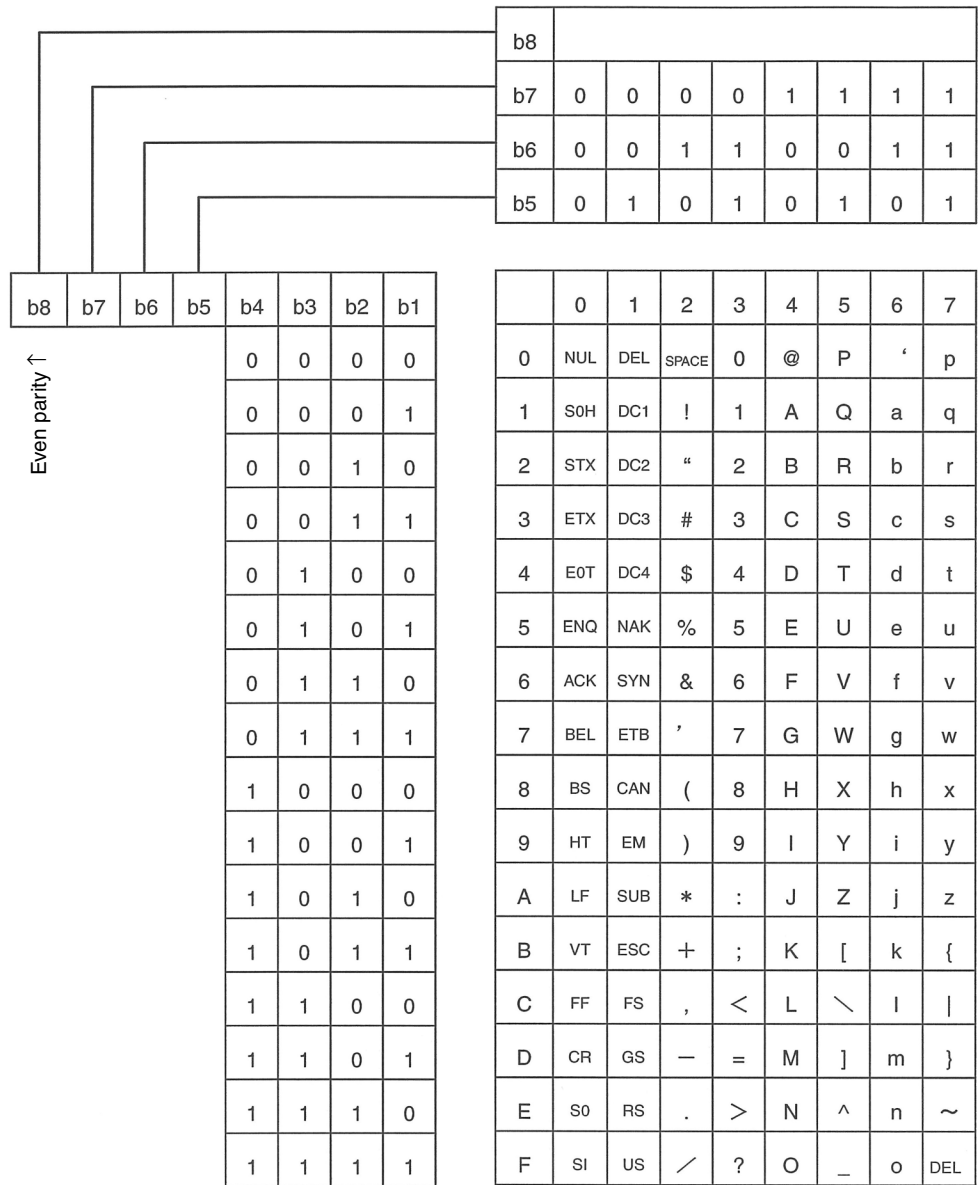

SECTION 8

Error Processing

This section explains how to troubleshoot errors that may occur when using the S8M.

8-1	Troubleshooting	122
8-2	Seven-segment Error Codes	123
8-3	Clearing Errors	125

8-1 Troubleshooting

If the S8M is not operating properly, check the items listed in the following table before requesting repairs. If the problem cannot be remedied, contact your OMRON sales representative.

Stage	Observed problem	Possible cause	Remedy	Reference page
Installation	The S8M was installed on a DIN Rail, but the bottom of the S8M is not attached.	The S8M's bottom latch is not mounted properly.	Check that the S8M has been pressed until the bottom latch clicks.	37
Parameter settings	The desired alarm value is not being displayed.	The setting is not allowed in the present protection level.	Change the protection level setting.	54
	The set value was changed, but the change wasn't accepted.	The new setting was not saved.	After pressing the Up and Down Keys to change the set value, press the Mode Key and verify that the setting flashes and the setting is saved.	56
	The branch outputs are not working.	All branch outputs are disconnected in the default settings to ensure safety.	Switch to Test Mode and connect the desired branch outputs.	74
	When the S8M was switched to Run Mode after setting the overvoltage alarm and undervoltage alarm, the alarm output went OFF and cannot be cleared.	The undervoltage and overvoltage settings may have been reversed.	Switch to Setting Mode from the Mode Selection Menu and check the settings.	49, 60, 61
Equipment setup	The display is flashing "ON" in Test Mode, but power is not being supplied by the outputs.	A flashing "ON" display indicates that the S8M is waiting to turn ON the outputs.	If the Mode Key is pressed, the output will be connected and power will be supplied. When power is being supplied, "OFF" will flash on the display to indicate the S8M is waiting to turn OFF the output.	77
	The S8M was turned OFF in Test Mode, and there was no power from the outputs when the S8M was turned ON again.	If the power goes OFF in Test Mode, all of the branch outputs are cut off for safety reasons.	Connect the desired branch outputs in Test Mode and then switch to Run Mode or Setting Mode before turning OFF the power.	74
	When the output is connected in Test Mode, it is cut off immediately and can't be connected again.	Check whether the status indicator is lit red. The current may be higher than the abnormal current tripping value.	Check for problems such as output wiring and load connection problems. If no problems are found, press the Reset Key for at least 3 s.	74, 125
Operation	The displayed temperature is clearly different from the ambient temperature.	The S8M detects the S8M's internal temperature, which can be 10 to 20°C higher than the ambient temperature.	If the over-temperature output is being used to control a fan or cooling equipment, set the over-temperature output value based on the graph on page 29.	29, 63
	An alarm was output and the cause of the alarm was eliminated, but the alarm display was not cleared.	The S8M doesn't disregard temporary errors, so the display and output are maintained even after the cause of the alarm is cleared.	The alarm can be cleared by pressing the Reset Key for at least 3 s.	125

Stage	Observed problem	Possible cause	Remedy	Reference page
Operation	The peak output current is not displayed and the display shows “- - .”	The current may have exceeded the measurable range.	Clear the peak output current in Run Mode.	18, 79
	The peak output current is higher than the abnormal current tripping value, but the output has not been cut off.	The S8M provides a startup delay so that inrush currents do not cause tripping at startup. The output will thus not be cut off at startup, but the maximum current will be recorded as the peak output current.	Clear the peak output current using the operation provided. Thereafter, the peak output current during normal operation will be recorded.	79, 93, 136
	The output was not designed for a current that high, but the output is cut off as soon as power is supplied.	The abnormal current tripping type may be set to “instantaneous.” With instantaneous detection, an abnormal current is detected very quickly and the output may be cut off due to excessive current during equipment operation.	Either change the abnormal current tripping type from instantaneous to standard or increase the current tripping value.	58
		There may be a large number of devices connected to the output. The more devices that are connected, the higher the operating current.	Connect the devices to different branch outputs and use the S8M's startup sequence to offset the connections to the devices.	30, 64
Branch output cutoff	The connection cannot be reset immediately after it is cut off (RST) is displayed.	To protect the S8M's internal circuits, at least 15 seconds must pass before a cut-off output can be reset.	Press the Reset Key for at least 3 s. “RST” should be displayed and the cut-off output can be reset after 15 seconds have passed since the cutoff.	22, 125
	The output was reset, but it was immediately cut off again.	The original cause of the cut-off may not have been eliminated. After resetting the error, a large current may have flowed again.	Eliminate the problem that caused the cutoff and press the Reset Key for at least 3 s.	125
Saving or maintenance	The run time alarm was output, so the equipment was checked and other parts were replaced, but the alarm could not be cleared.	The S8M continues adding to the run time. The run time must be reset to 0 in order to clear the alarm.	Clear the run time and then press the Reset Key for at least 3 s. The alarm can also be cleared by increasing the run time value and then resetting.	62, 71, 125
	All of the outputs were disconnected when the parameters were initialized.	Initializing parameters returns all settings to their default values. To ensure safety, all outputs are disconnected by default.	The S8M will be in Setting Mode after initializing the parameters. Change to Test Mode and connect the required branch outputs.	53, 98, 133

8-2 Seven-segment Error Codes

Error Display List

Seven-segment display	Error code	Meaning	Probable cause and remedy
E98	E98	RAM error	These are S8M system errors. When one of these error codes is displayed, contact an OMRON representative regarding the error.
E97	E97	EEPROM read error	
E96	E96	EEPROM write error	
E94	E94	A/D conversion error	

Seven-segment display	Error code	Meaning	Probable cause and remedy	
	E10	Data other than communications data is corrupted.	There is an error in the parameter settings.	Press the Mode Key to switch to the parameter initialization display. After initializing the parameters, set them again.
	A10	Abnormal voltage tripping	The power supply voltage exceeded 28.8 V.	Check the power supply voltage.
	A11	Abnormal current tripping	The branch output's current exceeded the current tripping value.	Check whether the connected device is correct and check whether the set value is appropriate.
	A20	Overvoltage alarm	The input voltage exceeded the overvoltage alarm value.	Check the power supply voltage and the set value.
	A21	Undervoltage alarm	The input voltage dropped below the undervoltage alarm value.	
	A22	Overcurrent alarm	The branch output's current exceeded the overcurrent alarm value.	Check whether an excessive load is connected and check whether the set value is appropriate.
	A23	Run time alarm	The run time exceeded the run time value.	Reset the run time. If the run time alarm is not needed, set the alarm value to 0.0.
	A30	Over-temperature output	The S8M's internal temperature exceeded the over-temperature output value.	Check for a high ambient temperature and check the setting of the over-temperature output value. Take steps to reduce the temperature in the control panel.

- When two or more errors occur simultaneously, the higher priority error (higher in the table above) will be displayed.
- The A11 and A22 errors may occur simultaneously in two or more branch outputs. In this case, the corresponding branch output indicators will not be lit.

8-3 Clearing Errors

When an error has occurred, the error code will be displayed on the seven-segment display. Eliminate the cause of the error and clear the error.

It is possible to clear an error immediately after it occurs, but once an error has been reset, another reset operation cannot be performed for at least 15 seconds to protect the S8M's internal circuits.

Errors can be cleared (reset) by pressing the Reset Key (RST) on the S8M or executing a Support Tool operation.

Clearing Errors with the Reset Key

The Reset Key (RST) can be pressed for 3 s or longer to clear an error and supply power to an output that was cut off.

The following example shows the display when branch output 1 was cut off because an abnormal current was detected. If an error occurs, first determine the cause of the error and eliminate the cause.

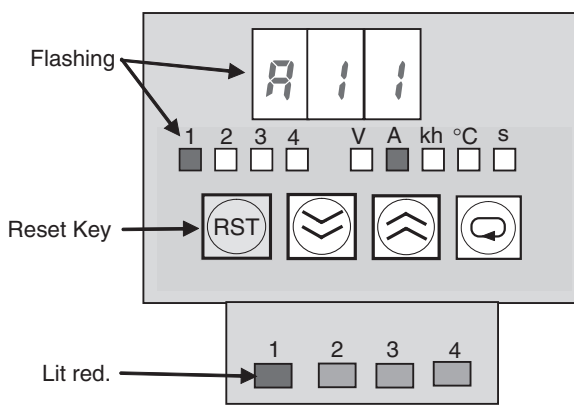

- The seven-segment display alternately shows error code A11 and the measured current.
- The branch output 1 indicator and unit indicator (A) will flash along with the measured current.
- Status Indicator 1 will be lit red.

Clearing the Error

Press the Reset Key for at least 3 s to clear the error. Power will be supplied at the output again.

Even if an error such as an overcurrent occurs in Setting Mode or Test Mode, the error code will not be displayed, and the error cannot be reset with the Reset Key.

When the S8M is switched to Run Mode, the error code will be displayed and the error can be reset with the Reset Key.

Note When the Reset Key is pressed for 3 s, "RST" will be displayed on the seven-segment display.

Identifying and Correcting the Cause of the Error

When an error code is displayed on the seven-segment display, determine whether an error actually occurred or there is a problem with the parameter setting.

Correcting Abnormal Current Tripping (A11) Errors

When error code A11 (abnormal current tripping) and the current are displayed alternately on the seven-segment display, there are two possible causes. Check whether the load connected to the output is too large or the current setting is too low.

- If there are too many loads connected, split up the loads.
- If the current setting is too low, increase the setting.

- If the overcurrent is occurring momentarily, check the abnormal current tripping type setting on page 58. The detection of short-lived abnormal currents can be prevented by changing the setting from instantaneous detection (detection after 10 ms) to standard detection (detection after 80 ms).

Over-temperature Output (A30) Displayed

When error code A30 (over-temperature) and the temperature are displayed alternately on the seven-segment display, there are two possible causes. Check whether the S8M's internal temperature is too high or the setting of the over-temperature output value is too low.

Run Time Alarm (A23) Displayed

When error code A23 (run time alarm) is displayed on the seven-segment display, check whether some component in the system requires maintenance or there is a problem with the setting of the run time value.

- If outputting run time alarms is not required, set the alarm value to 0.0 kh.
- When you want to clear the run time, execute the clear run time operation in Setting Mode (see page 71). The run time cannot be cleared from the Support Tool.

Reading and Clearing Errors from the Support Tool

Select **Monitor - Status** or **Monitor - Present Values** to display the Status Window or Present Values Window. Errors can be checked and cleared from these windows. First identify and eliminate the cause of the error and then click the **Reset** Button.

Example Error Display in the Status Window

The screenshot shows a 'Status' window with the following data:

Input voltage	Normal		
Branch output	1	Active abnormal current trip	7.7 A
	2	Normal	
	3	Normal	
	4	Normal	
Internal temperature	Normal		
Run time	Normal		
External tripping input	OFF		

Below the table is a 'Current connection status' section with a 'Branch output' sub-table:

Current connection status	Branch output			
	1	2	3	4
	○	○	○	○

At the bottom of the window are three buttons: 'Reset', 'Present Values', and 'Close'. Annotations include: 'Message' pointing to the error message, 'Current when output was cut off.' pointing to '7.7 A', 'Reset Button' pointing to the 'Reset' button, and 'Lit red because the output was cut off.' pointing to the 'Current connection status' indicators.

Example Error Display in the Present Values Window

The screenshot shows a software window titled "Present Values" with a close button in the top right corner. The window is divided into several sections:

- Input:** A box containing "Input voltage (V)" and the value "24.1".
- Outputs:** A table with four rows for "Branch output" (1-4) and one row for "Total current (A)".

		Branch output current (A)	Peak output current (A)	Peak output current clear
Branch output	1	0.0	7.9	Clear
	2	0.0	0.0	Clear
	3	0.0	0.1	Clear
	4	0.0	0.0	Clear
Total current (A)		0.0		
- Internal temperature (oC):** A box containing a dash "—".
- Run time (kh):** A box containing the value "0.0".
- Branch output connection status:** A table with four columns (1-4) and one row for "Current connection status".

	1	2	3	4
Current connection status	0	0	0	0
- Shunt output:** A table with four columns (1-4) and two rows for "Connect" and "Disconnect".

	1	2	3	4
Connect	o	o	o	o
Disconnect	x	x	x	x
- Control buttons:** Three stacked buttons labeled "Startup sequence", "Shutdown sequence", and "Reset". Below them are "Monitor Status" and "Close" buttons.

Current when output was cut off.

Lit red because the output was cut off.

Reset Button

Appendix A

Glossary

The following table lists terms related to the S8M Digital Multicircuit Protector and a brief description of the terms. For details, see the referenced page.

Term	Meaning	Page
abnormal current tripping	When a branch output's current exceeds the set value, that output is cut off. The tripping value can be set between 0.5 and 4.0 A (0.5 to 3.8 A in the UL Class 2 output model). The Tripping Alarm Output (TRP) is turned OFF when the output is cut off.	21, 57
abnormal voltage tripping	When the input voltage exceeds 28.8 V, all of the branch outputs will be cut off immediately. The Tripping Alarm Output (TRP) is turned OFF when the outputs are cut off. It is not necessary to set parameters for this function.	26
alarm output	The Alarm Output (ALM) is turned OFF when the S8M detects an overcurrent, overvoltage, undervoltage, or excessive run time.	26, 40
alarm type	A branch output's overcurrent alarm can be detected with standard detection (tripping within 100 ms) or instantaneous detection (tripping within 20 ms).	59
ALM	ALM is an abbreviation for the Alarm Output Terminal. The ALM output is turned OFF when an overcurrent, overvoltage, undervoltage, or excessive run time is detected.	14, 41
branch output	A branch output is one of the S8M's output circuits. The S8M has four branch outputs.	2, 40
communications	The standard model (S8M-CP04-R) and UL Class 2 output model (S8M-CP04-RS) are equipped with an RS-232C port. The S8M can be connected to a computer running the Support Tool or a network such as a CompoWay/F network.	6, 41
communications settings	The RS-232C port settings must be set when connecting to the Support Tool or a host computer.	67 to 71, 96
CompoWay/F	CompoWay/F is one of OMRON's general-purpose FA networks.	6
current fuse	When a branch output could not be cut off by the semiconductor relay, a current fuse will blow to protect the circuit. If the fuse blows, that branch output will become unusable.	16, 26
cut off	A branch output will be cut off when the S8M detects an abnormal current or voltage. At this point, the error code will be displayed on the seven-segment display and the Tripping Alarm Output (TRP) will be turned OFF.	26
DIN Rail	Used to install the S8M.	37
external tripping input	Branch outputs can be forcibly cut off with an input to the External Tripping Input (TRG terminal). The shutdown sequence function will operate in this case. The Support Tool and communications can also be used to cut off branch outputs, in addition to the External Tripping Input (TRG terminal).	40, 31
instantaneous detection (alarm type and tripping type)	Each branch output's tripping current and abnormal current can be detected with standard detection (tripping within 100 ms) or instantaneous detection (tripping within 20 ms). With instantaneous detection, the output will be cut off or the alarm will be output within 20 ms if the current is higher than the set value continuously for 10 ms or longer.	57, 59
monitoring	The S8M's operating status can be seen at a glance by connecting the Support Tool. The Present Values Window or Status Window can be selected.	93
operating mode	There are three operating modes in the S8M: Run Mode, Setting Mode, and Test Mode.	7, 49
overcurrent alarm	When the branch output's current exceeds the preset alarm value, the Alarm Output (ALM) is turned OFF. The alarm value can be set between 0.5 and 4.0 A (0.5 to 3.8 A in the UL Class 2 output model).	25, 58
over-temperature output	The S8M has a built-in temperature sensor that monitors the internal temperature. The Over-temperature Output (TMP) will be turned OFF when the internal temperature exceeds the set value.	28, 63

Term	Meaning	Page
overvoltage alarm	When the input voltage exceeds the preset alarm value, the Alarm Output (ALM) is turned OFF. The alarm value can be set between 20.0 and 28.8 V.	26, 61
peak output current	The peak output currents for branch outputs 1 to 4 can be read in Run Mode. The peak output currents can be cleared using S8M key operations or from the Support Tool.	
protection level	The protection level can be set to one of three levels to restrict read/write access to the parameters. This function can be used to prevent parameters from being changed or deleted inadvertently.	54, 54, 97
RS-232C port	The standard model (S8M-CP04-R) and UL Class 2 output model (S8M-CP04-RS) are equipped with an RS-232C port. The RS-232C port can be connected to a computer running the Support Tool or a host computer.	14, 41
Run Mode	Each branch output is connected and the input voltage, current, internal temperature, and run time are monitored continuously.	8, 78
run time alarm	Tracks the run time and outputs an alarm when the run time exceeds the alarm value.	30, 71
run time clearing	The run time can be cleared.	71
semiconductor relay	Branch outputs are not cut off mechanically in the S8M. Each branch output is connected/cut off by a high-capacity FET (transistor).	2
Setting Mode	This operating mode is used to set the parameters. A new S8M automatically starts in Setting Mode when it is turned ON for the first time.	9, 51
shutdown sequence	When outputs are cut off by the external tripping signal, the shutdown sequence can set a separate delay for cutting off each branch output.	31, 65
standard detection (alarm type and tripping type)	Each branch output's tripping current and abnormal current can be detected with standard detection (tripping within 100 ms) or instantaneous detection (tripping within 20 ms). With standard detection, the output will be cut off or the alarm will be output within 100 ms if the current is higher than the set value continuously for 80 ms or longer.	57, 59
startup delay	Tripping operation can be disabled for 70 ms when the power is turned ON in order to prevent the inrush current from being detected as an abnormal current and cutting off operation. The peak output current value will still be updated during the startup delay.	30
startup sequence	The startup sequence can set a separate delay for the connection of power to each branch output. This function can reduce the inrush current and voltage drop that occur when the power is turned ON.	30, 61
Support Tool	The Support Tool can be used to set/save the S8M's various parameters, monitor operation, and force outputs ON and OFF. The Support Tool can be downloaded to a computer (Windows 2000 or XP) from OMRON's home page free of charge.	<i>SECTION 6 Support Tool</i>
Test Mode	Each branch output can be set to ON or OFF (connected or disconnected). Also, the operation of the startup sequence and shutdown sequence can be verified.	9, 74
thermal fuse	If current is not cut off by the semiconductor relay alone, the built-in thermal fuse will blow to protect the circuit.	16, 26
TMP	TMP is an abbreviation for the over-temperature output terminal. The ALM output is turned OFF when the temperature exceeds the over-temperature output value. The TMP output is independent of the alarm output, so it can be used to control cooling equipment to reduce the temperature in the control panel.	14, 41
TRG	TRG is an abbreviation for "trigger" and represents the external tripping input. Power at selected branch outputs can be forcibly cut off by an external input signal. The shutdown sequence function will operate in this case.	14, 41
tripping alarm output	When the S8M detected an abnormal voltage or current, the branch output is cut off and the Tripping Alarm Output (TRP) is turned OFF.	3
tripping type	A branch output's tripping current can be detected with standard detection (tripping within 100 ms) or instantaneous detection (tripping within 20 ms).	57

Term	Meaning	Page
TRP	TRP is an abbreviation for the tripping alarm output terminal. This output is turned OFF when an abnormal current or abnormal voltage exceeds the corresponding set value.	14, 41
UL Class 2 output	An output that complies with the UL Class 2 rating.	3, 17
undervoltage alarm	When the input voltage is below the preset alarm value, the alarm output (ALM) is turned OFF. The alarm value can be set between 18.0 and 26.4 V.	27, 61

Appendix B

List of Operations

Mode Selection Menu Operations

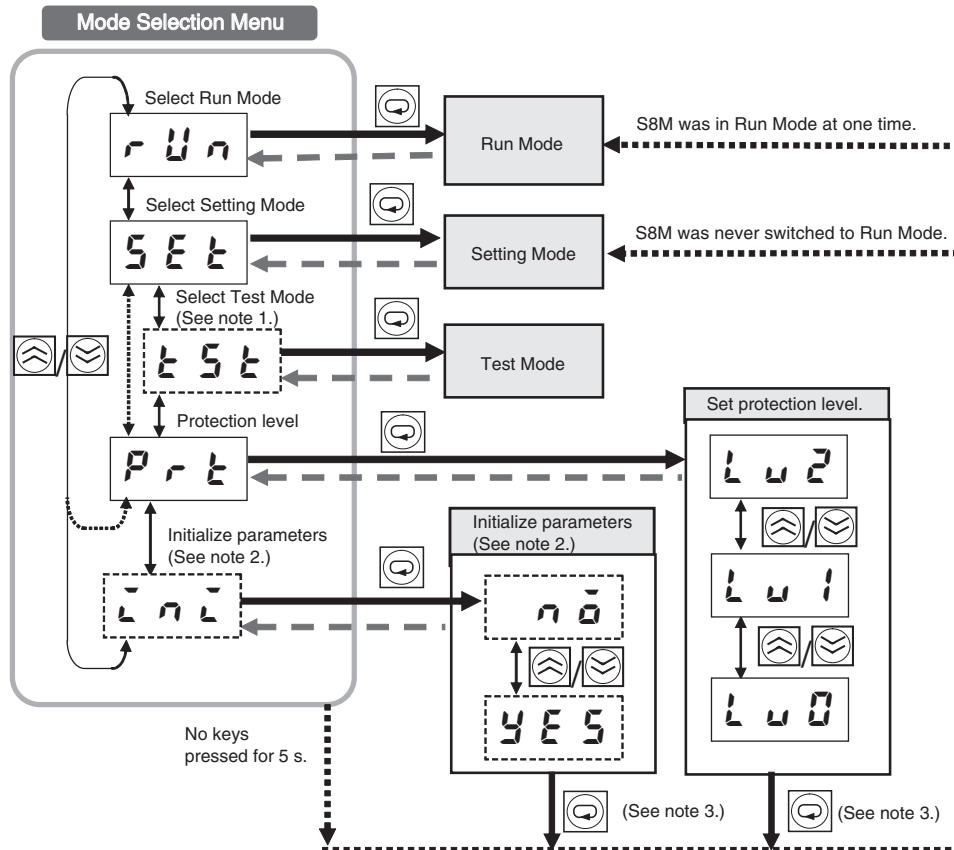

Note 1: The "TST" display does not appear in protection level 2.

Note 2: The "INI" display does not appear in protection level 1 or 2.

Note 3: The display will also change if the Mode Key is not pressed to save the setting and no other key is pressed for 5 s or longer.

← - - - (↑) + (↓) (Press for 3 s.)

Setting Mode

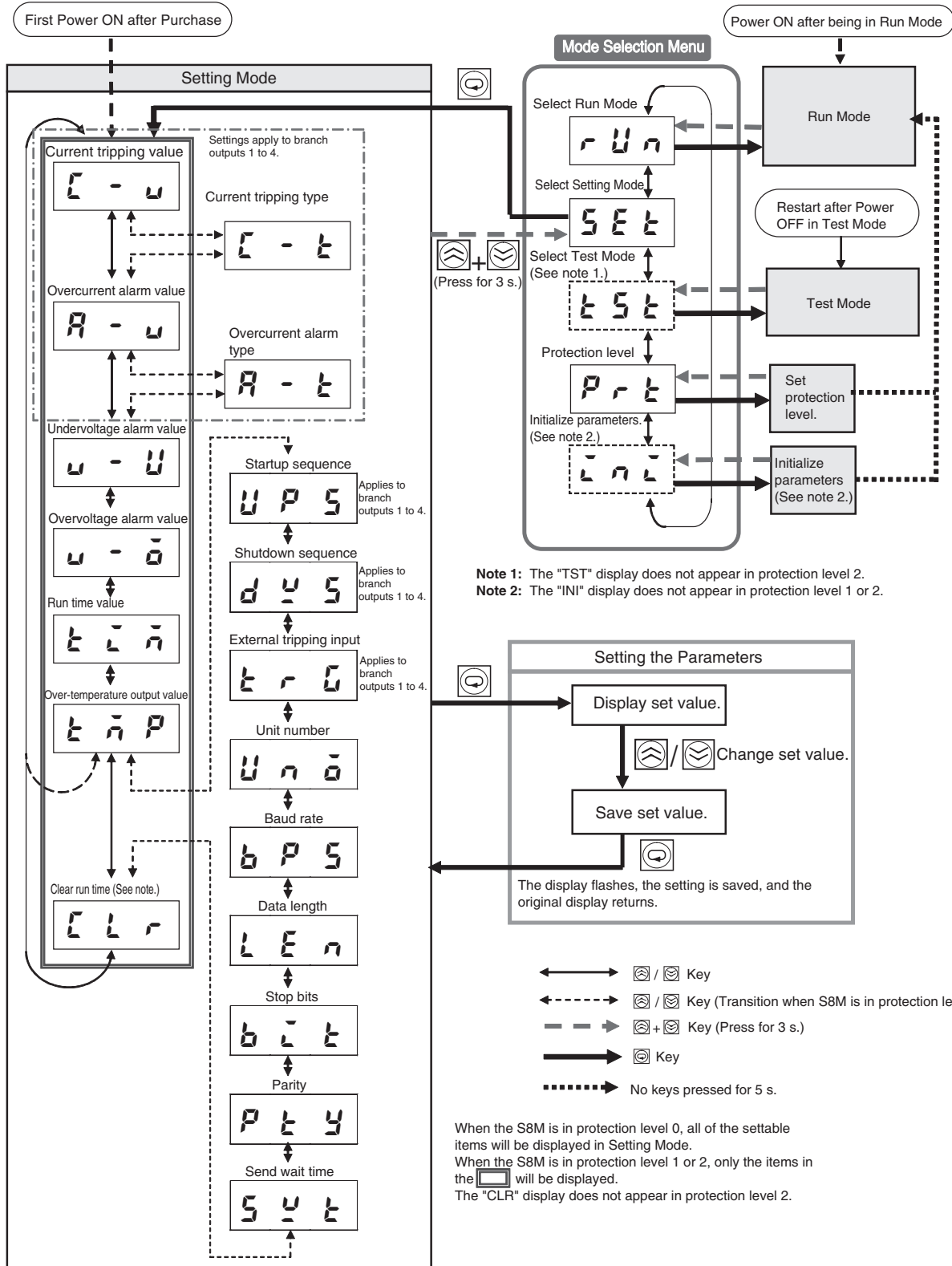

Test Mode

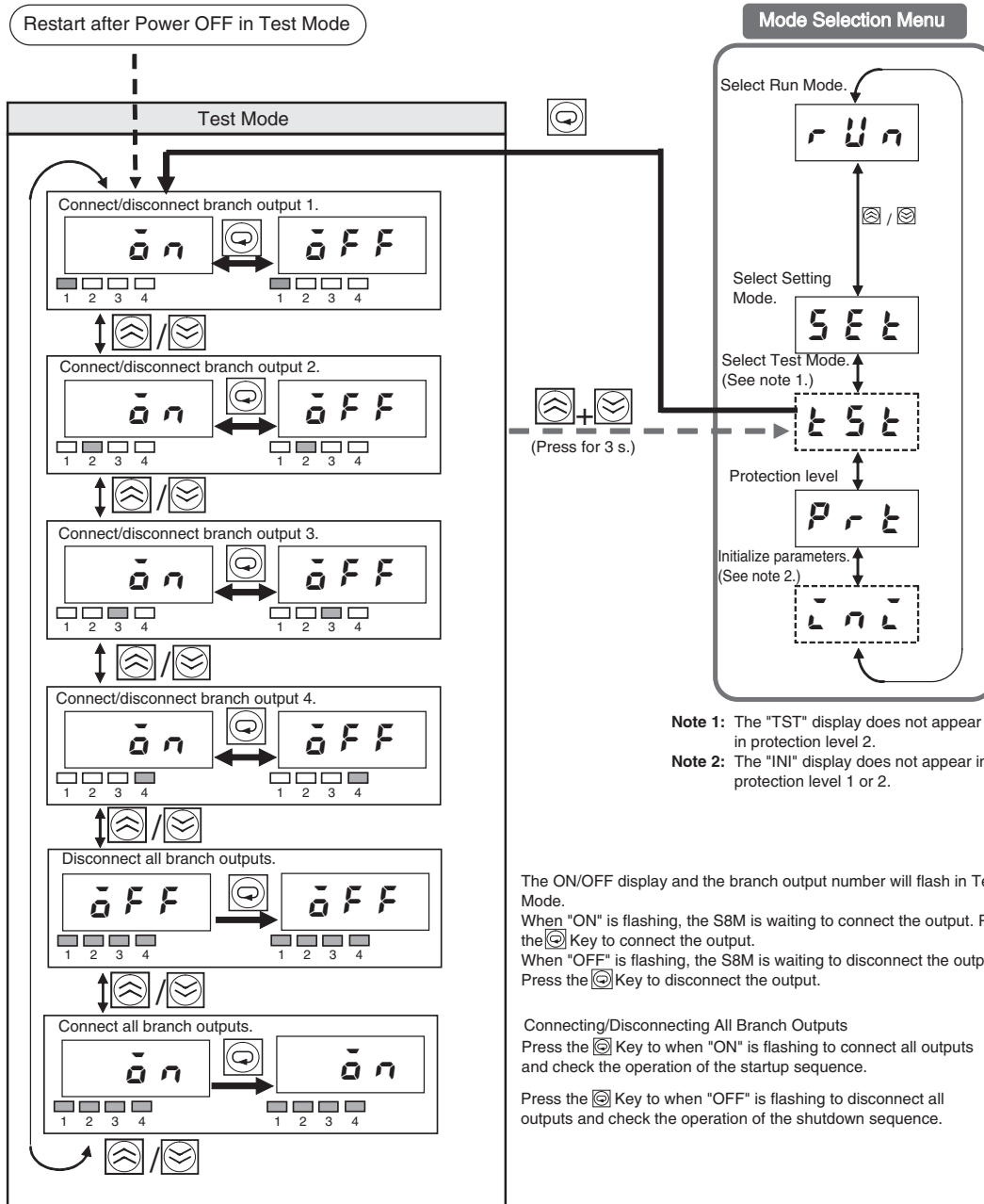

The ON/OFF display and the branch output number will flash in Test Mode.
 When "ON" is flashing, the S8M is waiting to connect the output. Press the Key to connect the output.
 When "OFF" is flashing, the S8M is waiting to disconnect the output. Press the Key to disconnect the output.

Connecting/Disconnecting All Branch Outputs
 Press the Key to when "ON" is flashing to connect all outputs and check the operation of the startup sequence.

Press the Key to when "OFF" is flashing to disconnect all outputs and check the operation of the shutdown sequence.

Run Mode

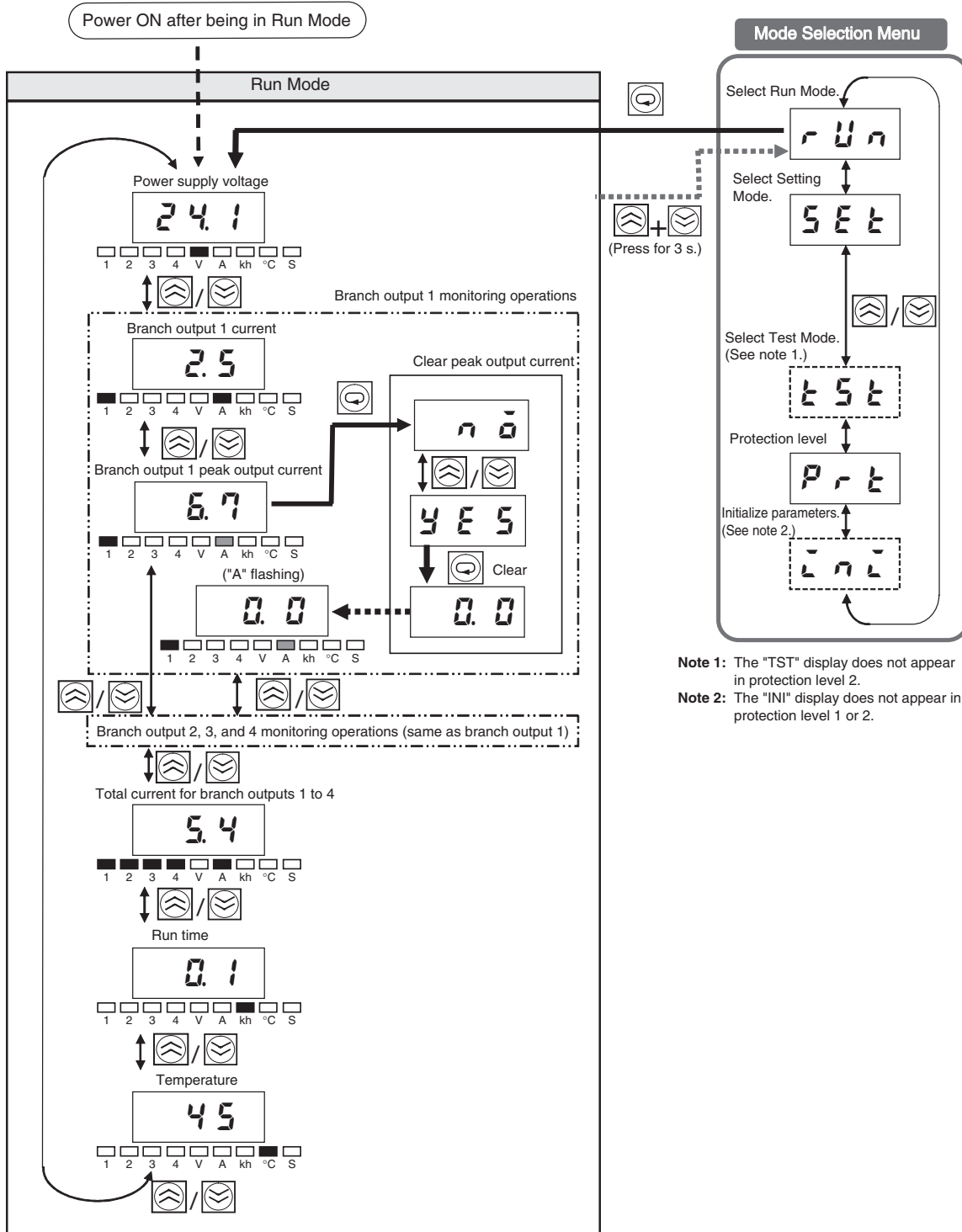

Revision History

A manual revision code appears as a suffix to the catalog number on the front cover of the manual.

Cat. No. Z241-E1-01

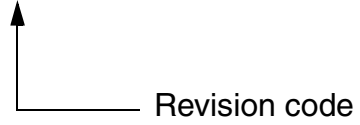

The following table outlines the changes made to the manual during each revision. Page numbers refer to the previous version.

Revision code	Date	Revised content
01	June 2006	Original production

Revision History

OMRON

OMRON Corporation
Industrial Automation Company

Control Devices Division H.Q.
Power Electronics Department
Shiokoji Horikawa, Shimogyo-ku,
Kyoto, 600-8530 Japan
Tel: (81)75-344-7108/Fax: (81)75-344-7189

Regional Headquarters

OMRON EUROPE B.V.
Wegalaan 67-69, NL-2132 JD Hoofddorp
The Netherlands
Tel: (31)2356-81-300/Fax: (31)2356-81-388

OMRON ELECTRONICS LLC
1 East Commerce Drive, Schaumburg, IL 60173
U.S.A.
Tel: (1)847-843-7900/Fax: (1)847-843-8568

OMRON ASIA PACIFIC PTE. LTD.
83 Clemenceau Avenue,
#11-01, UE Square,
239920 Singapore
Tel: (65)6835-3011/Fax: (65)6835-2711

OMRON (CHINA) CO., LTD.
Room 2211, Bank of China Tower,
200 Yin Cheng Road (M),
Shanghai, 200120 China
Tel: (86)21-5037-2222/Fax: (86)21-5037-2200

In the interest of product improvement, specifications are
subject to change without notice.

Authorized Distributor: