

OMRON

Model ZUV-C20H

UV-LED Irradiator Controller

INSTRUCTION SHEET

Thank you for selecting OMRON product. This sheet primarily describes precautions required in installing and operating the product.

Before operating the product, read the sheet thoroughly to acquire sufficient knowledge of the product. For your convenience, keep the sheet at your disposal.

TRACEABILITY INFORMATION:

Importer in EU :
Omron Europe B.V.
Wegalaan 67-69
2132 JD Hoofddorp,
The Netherlands

Manufacturer:
Omron Corporation,
Shiokoji Horikawa, Shimogyo-ku,
Kyoto 600-8530 JAPAN

The following notice applies only to products that carry the CE mark:
Notice:
This is a class A product. In residential areas it may cause radio interference, in which case the user may be required to take adequate measures to reduce interference.



© OMRON Corporation 2008 All Rights Reserved.

PRECAUTIONS FOR SAFE USE

Observe the following precautions to ensure safe operation.

- Do not use the product in atmospheres containing flammable or explosive gases.
- Do not install the product close to high-voltage devices and/or power devices in order to secure the safety of operations and maintenance.
- Do not use it exuding provided AC adapter (100 to 240 VAC ±10 %).
- Do not short-circuit the load to the output terminal (open-collector).
- Do not exceed the rated load.
- Lay the product cable away from any high-voltage cable or power line. If laid in the same conduit or duct, induction noise from them may caused malfunction or breakdown of the product.
- In the event of smoke, excessive heat of the cover or strange smell out of the product, immediately stop operation of the product, turn OFF the power supply, and disconnect the plug from the outlet. As repair by the customer is dangerous, contact an OMRON's local office or sales office.
- Do not try to disassemble, repair, or modify the product. Doing so may result in malfunctions, causing fire or electric shock.
- Dispose this product as industrial waste.
- Do not drop this product. In the event of dropping or breaking the product, turn OFF the power supply, disconnect the power plug from the outlet, and then contact an OMRON's local office or sales office.
- Do not put foreign material into a vent hole. Doing so may result in fire or electric shock.
- Do not closely contact or pile up controllers. Doing so may result in fire or faults.
- Do not touch the power plug with wet hands. Doing so may result inelectric shock.

Applicable standards

- EN61326-1
- Electromagnetic environment : Industrial electromagnetic environment (EN/IEC 61326-1 Table 2)

PRECAUTIONS FOR CORRECT USE

- Avoid installing the product in the following places:
 - Places exceeding the rated ambient temperature
 - Places exposed to extreme temperature changes (prevent condensation.)
 - Places where RH levels are outside the range 35% to 85%
 - Places subject to corrosive or flammable gases
 - Places subject to dust (including iron dust), or salts
 - Places subject to direct shock or vibration
 - Places subject to disturbance light such as ultraviolet (UV), laser beam, welding arc
 - Places subject to direct sunlight or places close to heaters
 - Places subject to exposure to water, oil, or chemicals, or subject to mist
 - Places subject to strong magnetic field or electric field
- Power supply and wiring
 - When using the product, make sure FG (frame ground terminal) is connected.
 - When a surge current to the power supply might be anticipated, apply a surge absorber according to use environment.
 - After wiring, check the correctness of power supply wiring, grounding of the load and the adequacy of current to the load, before turning ON the power supply.
 - Be sure to turn OFF the power supply when mounting or demounting the head part.
 - Use the head and controller with combinations specified in this instruction sheet.
 - An extension cable can be used between head and controller. Do not use extended multiple cables.
- Cleaning
 - Avoid the use of thinner, benzine, acetone, and kerosene. Use of these solvents will melt the surface of the device.
 - Use commercially available alcohol.
 - Wipe out small dirt or dust carefully not to damage the lens using a soft cloth (such as a lens cleaner.) containing a small quantity of alcohol.

- Resin cure
 - State of resin cure changes depending on various factors. Continuously check the state of resin cure to set at the best condition.

- Replacing the head
 - When replacing a head, make sure to initialize the channel (CH) for the controller. Otherwise the cumulative irradiation time data before the head replacement remains and correct life management cannot be performed.

- Connecting the head
 - When reconnecting the head, make sure to connect to the same CH. If connected to another CH, irradiation cumulative time data of the head is not succeeded and collect life management cannot be performed.

- LED safety measures
 - As connected with the head, the unit generates UV that is classified as Class 3B, so, this controller provides functions such as safety key lock function. Use these functions according to requirements specified in JIS C 6802.

Installing the controller

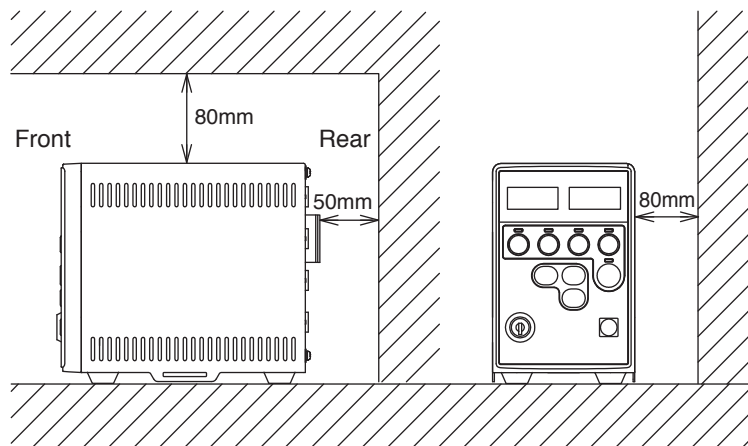

Dimensions (Unit: mm)

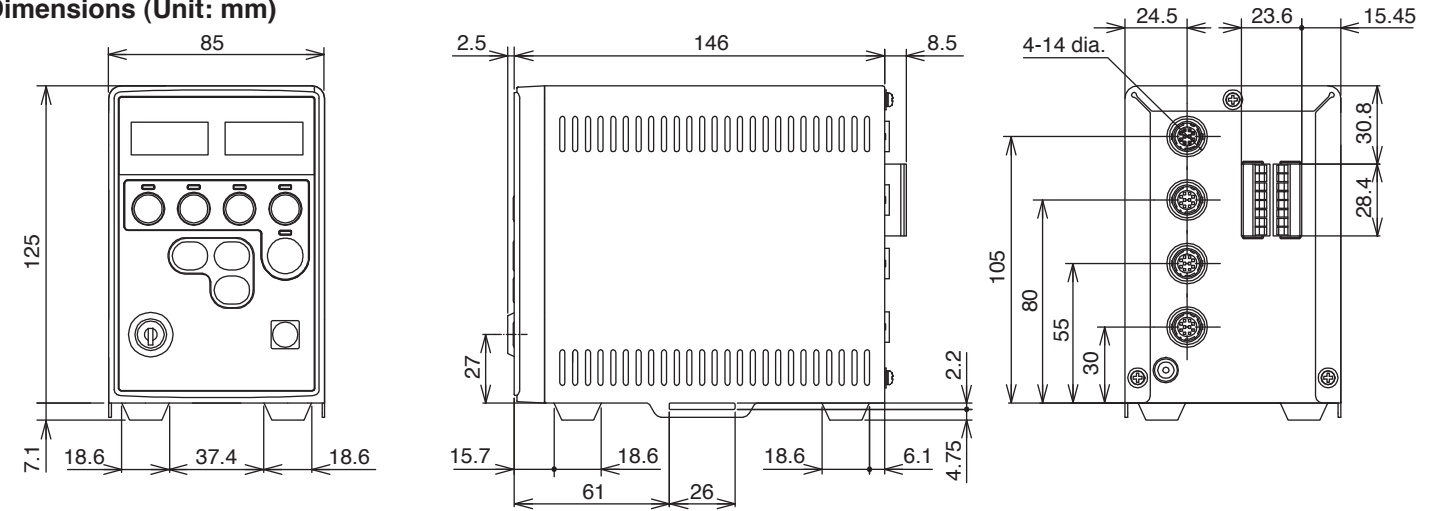

Ratings/Characteristics

Item	ZUV-C20H
Irradiation	Constant irradiation only (Irradiation power (0 to 100%), Irradiation time (99.9 sec. max./unlimited))
Terminal block	Emergency stop, UV irradiation start/stop (all CHs, 1 to 4 CH)
input/output	Ready output (All CHs, 1 to 4 CH), operating life output, error output
Cooling method	Natural air cooling (no fan)
Supply voltage	AC power supply only: 100 to 240 VAC +/-10%, 50/60 Hz (AC adapter is included.)
Current consumption	1.4 A (53 W) max.
Vibration resistance	10 to 150 Hz, Acceleration: 50 m/s ² , Single amplitude: 0.35 mm in X, Y, and Z directions, 10 sweeps each (8 min/sweep)
Shock resistance	150 m/s ² in 6 directions (+/-X, +/-Y, and +/-Z directions), 3 times each
Ambient temperature	Operating: 5°C to 35°C, Storage: -10°C to 60°C (with no condensation or icing)
Ambient humidity	Operating/storage: 30% to 85% (with no condensation or icing)
Degree of protection	IEC 60529 IP20
Applicable standard	EN 61326, EN 61010-1
Material	SECC, polycarbonate
Weight (in packing)	Approx. 1800 g (main unit: approx. 1200 g)
Accessories	Instruction sheet (this sheet), key, AC adapter

Names and Functions

Front

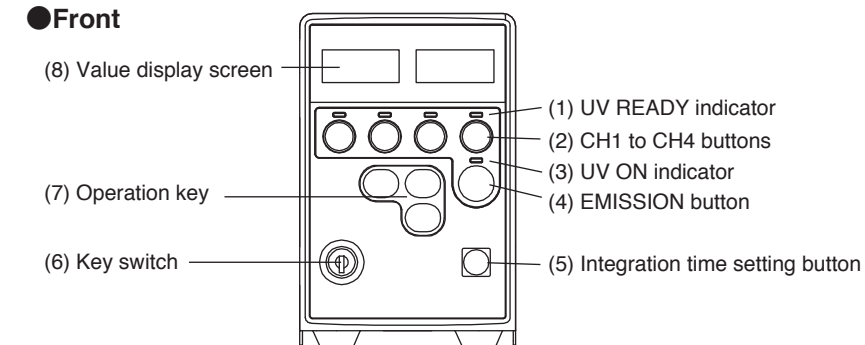

Rear

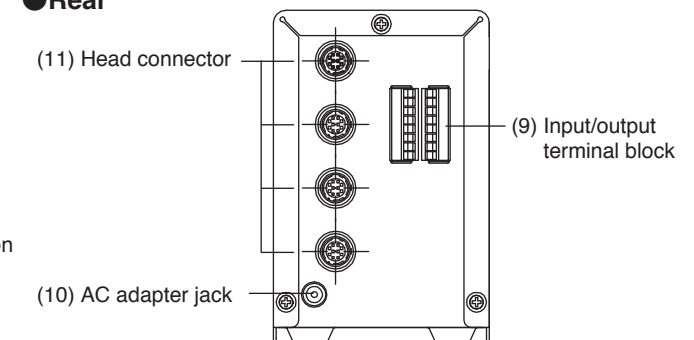

Name	Function
(1) UV READY indicator	Turns ON when UV irradiation is ready.
(2) CH1 to CH4 buttons	Selects a channel to change settings.
(3) UV ON indicator	Turns ON during UV irradiation.
(4) EMISSION button	Pressing this button starts or stops irradiation of UV light from an available head.
(5) Integration time setting button	Checks the irradiation integration time, and sets the operating life determination threshold value.
(6) Key switch	Turns ON/OFF the main power.
(7) Operation key (SET, ▲, ▼)	Sets the irradiation conditions (time, power), and operating life threshold value.
(8) Value display screen	Displays the irradiation conditions (time, power) and irradiation integration time.
(9) Input/output terminal block	Connects external devices such as a foot switch.
(10) AC adapter jack	Connects an AC adapter.
(11) Head connector	Connects a head.

Input/output Terminal Arrangement

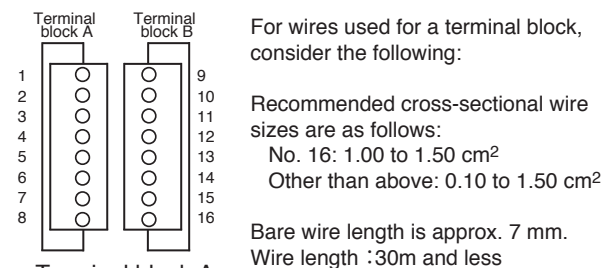

Terminal block A

No	Display	Input/output	Signal name
1	RDYALL	Output	All CHs of ready output
2	RDY1	Output	CH1 of ready output
3	RDY2	Output	CH2 of ready output
4	RDY3	Output	CH3 of ready output
5	RDY4	Output	CH4 of ready output
6	ERROUT	Output	Error output
7	LIFEOUT	Output	Life output
8	COMOUT	-	COM for output

Terminal block B

No	Display	Input/output	Signal name
9	TRGALL	Input	All CHs of UV irradiation start/end input
10	TRG1	Input	UV irradiation start/end input CH1
11	TRG2	Input	UV irradiation start/end input CH2
12	TRG3	Input	UV irradiation start/end input CH3
13	TRG4	Input	UV irradiation start/end input CH4
14	EMGCY	Input	Emergency stop input
15	COMIN	-	0 V (COM for input)
16	FG	-	Frame ground

Input/output Signal

Input/output	Signal name	Function
Input	UV irradiation start/end input	A trigger that starts/ends the UV light irradiation. All CHs: Starts/ends the UV light irradiation at the available heads CH1 to 4: CH that receives the signal starts/ends UV light irradiation. (See Operation Chart.)
	Emergency stop input	Stops the UV light irradiation at an emergency. To release the emergency stop state, never forget to turn OFF the emergency stop input and all irradiation inputs. (It is possible to release by turning OFF the key switch instead of turning OFF the irradiation inputs.) * No irradiation input is accepted until the emergency stop state is released.
Output	Ready output	Outputs when UV irradiation is available. All CHs: Outputs when UV irradiation is available for all CHs. CH1 to 4: Outputs when UV irradiation is available for each CH. (See Operation Chart.)
	Error output	Outputs when an error occurs. (See Error Messages and Measures.)
	Life output	Outputs when the head's total irradiation time stored in the controller exceeds the set threshold value. To release the life output, reset the irradiation integration time. * When the life output turns ON, the output continues until the irradiation integration time is reset.

Internal Specification

<Input Specification>

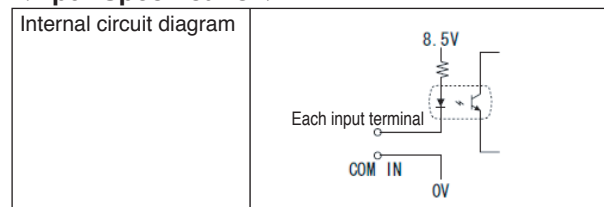

<Output Specification>

Output voltage	12 to 24 VDC +/-10%
Load voltage	45 mA max.
ON residual voltage	2 V max.
OFF leakage current	0.1 mA max.
Internal circuit diagram	

Connection

- Head connection
Insert the head to the head connection port on the back of the controller aligning the grooves of the port and the head connector.
- AC adapter connection
Connect the AC adapter to the AC adapter jack on the back of the controller.

Operation

- Startup and shutdown
 - <Startup>
Turn ON the key switch on the front of the controller. Irradiation is ready at this stage (irradiation mode). For the CH that is ready for irradiation, the indicator above the CH button lights or flashes.
 - <Shutdown>
Turn OFF the key switch in front of the controller.
- Operation mode transition
Press the SET button to switch the three modes: irradiation mode, irradiation power setting mode, and irradiation time setting mode.
- Irradiation (irradiation mode)
 - Irradiate all CHs at once.
In irradiation mode, both power and time indicators turn ON.
When pressing the EMISSION button on the front of the controller, UV light is irradiated from available CHs.
UV light is also irradiated by turning ON the UV irradiation start inputs (all CHs) on the back of the controller.
 - Irradiation by CH
When turning ON the UV irradiation start inputs (CH1 to 4) on the back of the controller, UV light is irradiated from the head connected to each CH.
Note: Individual irradiation in irradiation mode cannot be controlled with the front panel of the controller.

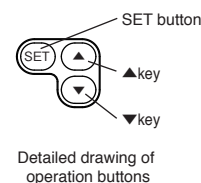
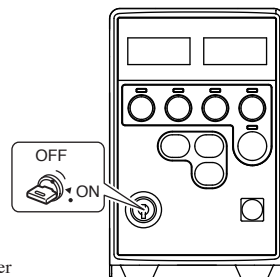

- Setting conditions (irradiation power setting mode, irradiation time setting mode)
 - Set or adjust the irradiation power. (irradiation power setting mode)
In irradiation power setting mode, the power indicator turns ON and time indicator turns OFF. Irradiation power can be set for each CH.
 - Hold down the CH button to select CH to set. The indicator of the held CH flashes.
 - Press ▲▼ keys to set the intended irradiation power. (All CHs are set at 100% on factory default)
Because only the set CH irradiates at the set power by pressing the EMISSION key, power adjustment can be made during irradiation.
Irradiation stops by pressing the EMISSION key again.
 - When continuously setting other CH's irradiation power, hold down the CH button.
 - Setting irradiation time (irradiation time setting mode)
In irradiation time setting mode, the time indicator turns ON and irradiation power indicator turns OFF.
Irradiation time cannot be set for individual CH.
 - Press ▲▼ keys to set intended irradiation time. (factory default is 10 sec)
 - When pressing ▼ key more than 0.0 sec, display show "--", the setting becomes unlimited irradiation state. In the unlimited irradiation state setting, the irradiation time is unlimited.
By pressing the EMISSION button, irradiation can be started/stopped.

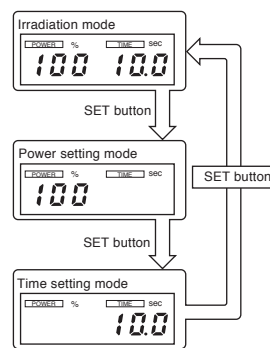

- Managing the operating life of the head (Life management mode)
The mode changes to life management mode by pressing the LIFE button for more than 2 seconds during the irradiation mode. The life management mode consists of "Life time threshold value setting" and "Cumulative irradiation time reset" modes. Setting can be made on each setting screen.
* The mode goes back to the irradiation mode by pressing the LIFE button for more than 2 seconds during each setting.
 - Setting the life threshold value (life threshold value setting mode)
The life management mode changes to the life threshold value setting mode by pressing down the LIFE button once. In the life threshold value setting mode, the life setting threshold value indicator turns ON, and cumulative irradiation time turns OFF.
 - Hold down the CH button to change the life threshold value.
 - Press ▲▼ keys to set a specified life threshold value. (2.70 x 10,000 hours on factory default)
 - When continuously setting other CH's life threshold value, hold down the CH button.
The changed life threshold value is confirmed, and the life threshold value of the selected CH is displayed.
 - The value can be also confirmed by pressing down the LIFE button once.
 - Resetting cumulative irradiation time (cumulative irradiation time reset mode)
By pressing down the LIFE button once at the life threshold value setting mode, it changes to the cumulative irradiation time reset mode. In the cumulative irradiation time reset mode, the cumulative irradiation time indicator turns ON, and the life setting threshold value indicator turns OFF.
 - Hold down the CH button to select a CH to reset the cumulative irradiation time.
 - The selected CH indicator flashes to show which CH should be reset.
 - When holding down both the ▲▼ keys for more than 1 second, the cumulative irradiation time is reset to 0.00.
 - When resetting other CH's cumulative irradiation time following the above ③, hold down the CH button.

* Note that a cumulative irradiation time cannot be recovered once the value is reset.

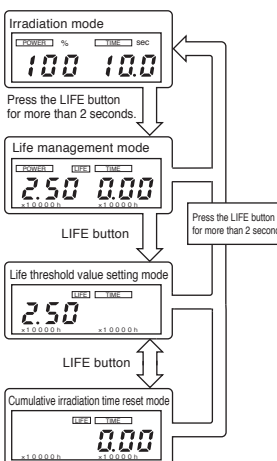

Operation Chart

1. Timer irradiation

1-1. All-channel irradiation

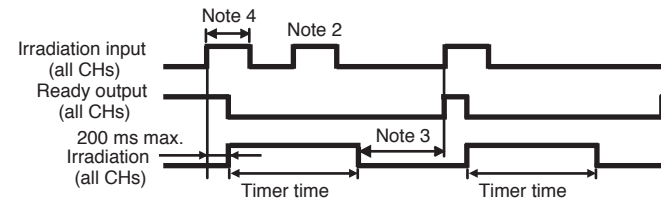

- Note 1: Individual irradiation input during all-channel irradiation is not accepted.
- Note 2: Irradiation input during irradiation (at Ready output OFF) is not accepted.
- Note 3: An interval for the next irradiation input after an irradiation stop must be at least 200 ms.
- Note 4: Input signal must be at least 200 ms.

1-2. Individual channel irradiation

In the case of individual channel irradiation, irradiation can be performed for each channel.

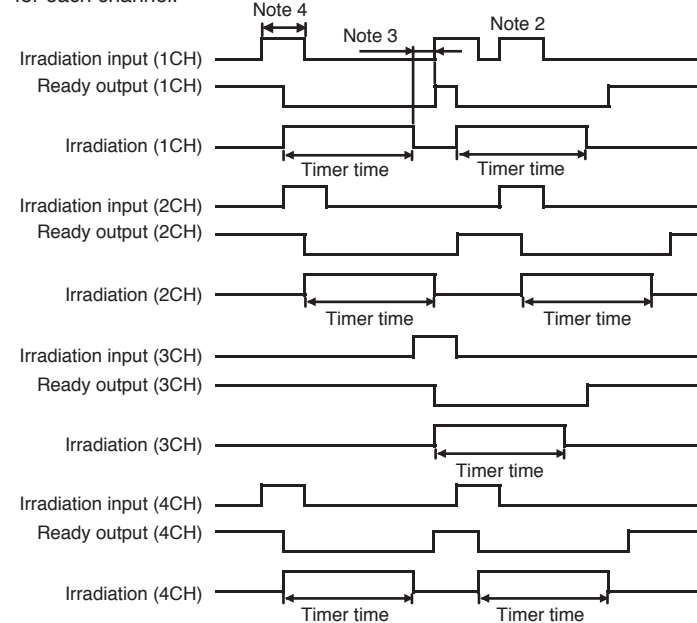

- Note 1: All-channel irradiation input during individual channel irradiation is not accepted.
- Note 2: Irradiation input during irradiation (at Ready output ON) is not accepted.
- Note 3: An interval for the next irradiation input after an irradiation stop must be at least 200 ms.
- Note 4: Input signal must be at least 200 ms.

2. Unlimited irradiation

2-1. All-channel irradiation

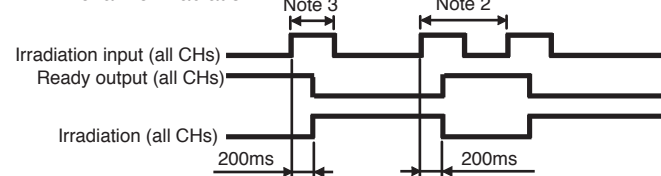

- Note 1: Individual irradiation input during all-channel irradiation is not accepted.
- Note 2: An interval between signal inputs must be at least 400 ms.
- Note 3: Input signal must be at least 200 ms.

2-2. Individual channel irradiation

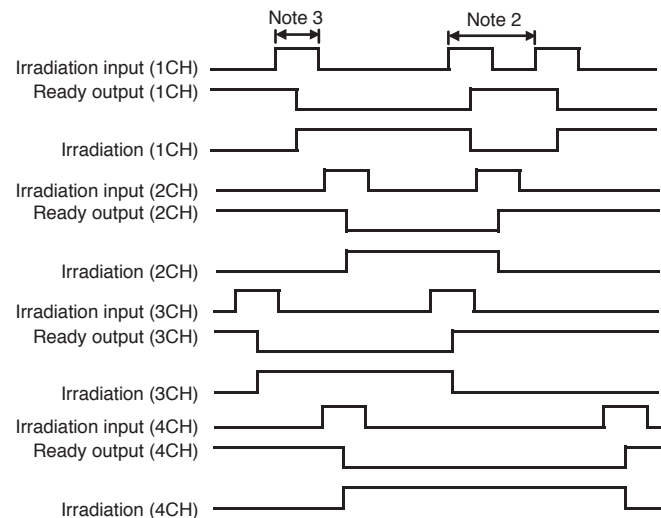

- Note 1: All-channel irradiation input during individual channel irradiation is not accepted.
- Note 2: An interval between signal inputs must be at least 400 ms.
- Note 3: Input signal must be at least 200 ms.

Error Messages and Measures

Display	Cause	Measures
Err 000	A head failure or head disconnection (Note 2, 3)	Turn OFF the key switch. Make sure that the head is surely connected, and then turn ON the key switch. If the error persists, replace the head or cable.
Err 001	EEPROM write failure	Press any one of the operation panel keys to release the error, and then make sure that the setting value is correctly entered. Set up again. If the error persists, contact your OMRON representative.
Err 002	EEPROM read failure	Press any one of the operation panel keys to release the error, and make sure that the setting value is correctly entered. Set up again. If the error persists, contact your OMRON representative.
Err 003	System error (Note 2)	Turn OFF the key switch and turn it ON again. If the error persists, contact your OMRON representative.

- Note 1: When an error is detected, the error output turns ON, and all "ready" outputs turn OFF.
- Note 2: UV irradiations at all channels stop.
- Note 3: A CH indicator for a failed head flashes.

Suitability for Use

Omron Companies shall not be responsible for conformity with any standards, codes or regulations which apply to the combination of the Product in the Buyer's application or use of the Product. At Buyer's request, Omron will provide applicable third party certification documents identifying ratings and limitations of use which apply to the Product. This information by itself is not sufficient for a complete determination of the suitability of the Product in combination with the end product, machine, system, or other application or use. Buyer shall be solely responsible for determining appropriateness of the particular Product with respect to Buyer's application, product or system. Buyer shall take application responsibility in all cases.

NEVER USE THE PRODUCT FOR AN APPLICATION INVOLVING SERIOUS RISK TO LIFE OR PROPERTY WITHOUT ENSURING THAT THE SYSTEM AS A WHOLE HAS BEEN DESIGNED TO ADDRESS THE RISKS, AND THAT THE OMRON PRODUCT(S) IS PROPERLY RATED AND INSTALLED FOR THE INTENDED USE WITHIN THE OVERALL EQUIPMENT OR SYSTEM.

See also Product catalog for Warranty and Limitation of Liability.

OMRON Corporation Industrial Automation Company
 Tokyo, JAPAN Contact: www.ia.omron.com

Regional Headquarters

■ **OMRON EUROPE B.V.**
Sensor Business Unit
 Carl-Benz-Str. 4, D-71154 Nufringen, Germany
 Tel: (49) 7032-811-0/Fax: (49) 7032-811-199

■ **OMRON ELECTRONICS LLC**
 2895 Greenspoint Parkway, Suite 200
 Hoffman Estates, IL 60169 U.S.A.
 Tel: (1) 847-843-7900/Fax: (1) 847-843-7787

■ **OMRON ASIA PACIFIC PTE. LTD.**
 No. 438A Alexandra Road # 05-05/08 (Lobby 2),
 Alexandra Technopark,
 Singapore 119967
 Tel: (65) 6835-3011/Fax: (65) 6835-2711

■ **OMRON (CHINA) CO., LTD.**
 Room 2211, Bank of China Tower,
 200 Yin Cheng Zhong Road,
 PuDong New Area, Shanghai, 200120, China
 Tel: (86) 21-5037-2222/Fax: (86) 21-5037-2200